



Version 10.00

This Computer program (including software design, programming structure, graphics, manual, and on-line help) was created and published by STRUCTUREPOINT, formerly the Engineering Software Group of the Portland Cement Association (PCA) for the engineering design and analysis of reinforced concrete walls, tilt-up walls, and precast architectural and load-bearing panels.

While STRUCTUREPOINT has taken every precaution to utilize the existing state-of-the-art and to assure the correctness of the analytical solution techniques used in this program, the responsibilities for modeling the structure, inputting data, applying engineering judgment to evaluate the output, and implementing engineering drawings remain with the structural engineer of record. Accordingly, STRUCTUREPOINT does and must disclaim any and all responsibility for defects or failures of structures in connection with which this program is used.

Neither this manual nor any part of it may be reproduced, edited, transmitted by any means electronic or mechanical or by any information storage and retrieval system, without the written permission of STRUCTUREPOINT, LLC.

All products, corporate names, trademarks, service marks, and trade names referenced in this material are the property of their respective owners and are used only for identification and explanation without intent to infringe. spWall[®] is a registered trademark of STRUCTUREPOINT, LLC.

Copyright © 1988 – 2022, STRUCTUREPOINT, LLC. All Rights Reserved.

Chapter 1: INTRODUCTION

1.1. Program Features.....	10
1.2. Program Capacity	12
1.3. System Installation Requirements	13
1.4. Terms & Conventions	14

Chapter 2: SOLUTION METHODS

2.1. Introduction	16
2.1.1. Wall Systems	18
2.1.2. Coordinate Systems	21
2.2. Codes and Standards Provisions.....	22
2.2.1. Code Checks.....	22
2.2.1.1. Geometry Considerations	22
2.2.1.2. Material Considerations	22
2.2.1.3. Loading Considerations.....	23
2.2.2. Geometry Checks	24
2.2.3. Definitions and Assumptions	25
2.3. Analysis Methods	26
2.3.1. Overview of Finite Element Method (FEM) of Analysis.....	26
2.3.1.1. Plate Element.....	26
2.3.1.2. Stiffener Element.....	28
2.3.2. Modeling of Supports	31
2.3.2.1. Nodal Restraints	31
2.3.2.2. Nodal Springs	31
2.3.3. Modeling of Loads	32
2.3.3.1. Point Loads.....	32
2.3.3.2. Line Load	33
2.3.3.3. Uniform Area Loads.....	34
2.3.3.4. Linear Area Loads	34
2.3.3.5. Self-Weight	35

2.3.4.	Displacement and Stability - Cracking Coefficients	36
2.3.5.	Analysis Solution and Results	38
2.3.5.1.	Solution Process	38
2.3.5.2.	Solution Results.....	40
2.4.	Design Methods.....	43
2.4.1.	Element Design Forces.....	43
2.4.1.1.	Plate Elements	43
2.4.1.2.	Stiffener Elements	45
2.4.2.	Flexural Design	46
2.4.3.	Shear design of stiffener elements.....	48
2.4.4.	Calculating additional reinforcement due to shear & torsion.....	49
2.4.5.	Wall Shear Strength.....	52
2.5.	Detailing Provisions	53
2.5.1.	Reinforcement Under Concentrated Loads	53
2.5.2.	Reinforcement for Reentrant Corners	53
2.5.3.	Wall Anchorage and Dowel Design.....	53
2.5.4.	Reinforcement Confinement in Walls with High Compression.....	54
2.6.	Special Topics	56
2.6.1.	Cracking Coefficient and Effective Flexural Stiffness of Concrete Walls	56
2.6.2.	Shear Wall Seismic Design Considerations	56
2.6.3.	Retaining Wall Design Considerations	57
2.6.4.	Tank Wall Design Considerations.....	57
2.6.5.	Deep Beam & Transfer Girder Design Considerations.....	58
2.6.6.	Shear Wall Lateral Displacement and Stability in High-Rise Buildings	59
2.6.7.	Alternative Method for Out-of-Plane Slender Wall Analysis Limitations.....	59
2.6.8.	Multi-Story Tilt-up Wall Considerations	59
2.6.9.	Lifting, Shoring, and Bracing of Wall Panels	60
2.6.10.	Insulating Concrete Forms (ICF) Walls	60
2.7.	Code Provisions and Equations	61
2.7.1.	Flexure Design	61
2.7.1.1.	ACI 318-14.....	61

2.7.1.2.	ACI 318-11/08.....	63
2.7.1.3.	ACI 318-05.....	65
2.7.1.4.	ACI 318-02.....	67
2.7.1.5.	CSA A23.3-14.....	69
2.7.1.6.	CSA A23.3-04.....	71
2.7.1.7.	CSA A23.3-94.....	73
2.7.2.	Wall Shear Strength Provided by Concrete.....	75
2.7.2.1.	Wall Shear Strength Provided by Concrete – In-Plane	75
2.7.2.2.	Wall Shear Strength Provided by Concrete – Out-of-plane	78
2.7.3.	Shear and Torsion Design of Stiffener Elements	81
2.7.3.1.	ACI 318-14.....	81
2.7.3.2.	ACI 318-11/08.....	84
2.7.3.3.	ACI 318-05.....	87
2.7.3.4.	ACI 318-02.....	90
2.7.3.5.	CSA A23.3-14/04 (Simplified Method).....	93
2.7.3.6.	CSA A23.3-94 (Simplified Method).....	96
2.8.	References	99

Chapter 3: PROGRAM INTERFACE

3.1.	Start Screen.....	100
3.2.	Main Program Window	102
3.3.	Tables Window.....	107
3.4.	Reporter Window	111
3.5.	Print/Export Window	117

Chapter 4: MODELING METHODS

4.1.	Model Creation Concepts	121
4.1.1.	Physical Modeling Terminology	122
4.1.2.	Structural Objects	123
4.1.3.	Properties.....	124

4.1.4. Input Preparation	125
4.1.5. Modeling Considerations	127
4.1.5.1. Dock Door Restraints at Floor Slab	127
4.1.5.2. Wind Loads on Doors and Windows Openings	128
4.1.5.3. Roof Joist Load Applications	128
4.1.5.4. Modeling of Roof Diaphragm Restraints	128
4.2. Model Editing Concepts	129

Chapter 5: MODEL DEVELOPMENT

5.1. Opening Existing Models	134
5.2. Creating New Models.....	135
5.2.1. Project Information.....	135
5.2.2. Structural Grids	136
5.2.2.1. Working with Grids.....	136
5.2.2.2. Generating Grids	137
5.2.2.3. Adding Grids	137
5.2.2.4. Using the Grid Table	138
5.2.2.5. Working with labels	139
5.2.2.6. Grid Display Options.....	139
5.2.3. Generating Definitions	140
5.2.3.1. Objects.....	142
5.2.3.2. Properties.....	144
5.2.3.3. Restraints	151
5.2.3.4. Load Case / Combo.....	153
5.2.4. Creating Model Objects.....	156
5.2.4.1. Plates	156
5.2.4.2. Stiffeners	158
5.2.4.3. Restraints	161
5.2.4.4. Loads	163
5.2.4.5. Nodes.....	169
5.2.5. Editing Model Objects.....	171

5.2.5.1. Using the Left Panel Objects	171
5.2.5.2. Using the Left Panel Toolbar	180
5.2.5.3. Using the Right Click Menu at Viewport.....	188
5.2.5.4. Understanding Plate Layers.....	189
5.3. Modeling with Templates.....	190
5.3.1. Utilizing Templates	190
5.3.2. Template Ribbon	192
5.3.3. Template Left Panel	193
5.3.4. Types of Templates	194
5.4. Utilizing Predefined Examples.....	200
5.5. Importing Model Data	201
5.6. Exporting Model Data	202

Chapter 6: MODEL SOLUTION

6.1. Solve Options	204
6.1.1. Run Options.....	205
6.1.2. Second Order Effects.....	205
6.1.3. Maximum Allowable Out-of-Plane Deflection.....	206
6.1.4. Concrete Shear Strength of Wall Cross-Sections.....	206
6.2. Meshing Options	207
6.2.1. Maximum Allowed Mesh Size.....	207
6.2.2. Maximum Allowed Aspect Ratio.....	208
6.2.3. Circle Segments.....	208
6.2.4. Status	208
6.3. Running the Model.....	209

Chapter 7: MODEL OUTPUT

7.1. Tabular Output	211
7.1.1. Project.....	212
7.1.2. Definitions	213

7.1.3. Assignments	214
7.1.4. Analytical Model.....	215
7.1.5. Results	216
7.1.5.1. Envelope.....	216
7.1.5.2. Service	218
7.1.5.3. Ultimate	219
7.2. Graphical Output.....	221
7.2.1. Contours	221
7.2.1.1. Envelope.....	222
7.2.1.2. Service	224
7.2.1.3. Ultimate	224
7.2.1.4. Contour Display Options.....	225
7.2.2. Diagrams	226
7.2.2.1. Stiffener Internal Forces.....	227
7.2.2.2. Wall Cross-Sectional Forces	227
7.2.2.3. Wall Concrete Shear Strength	227
7.2.2.4. Diagrams Display Options	227
7.2.3. Viewing Aids.....	227
7.2.3.1. Multiple Viewports.....	228
7.2.3.2. View Controls.....	229
7.2.3.3. Display Options.....	230

Chapter 8: EXAMPLES

8.1. Example 1 - Load Bearing Wall.....	232
8.1.1. Problem Formulation.....	232
8.1.2. Preparing the Input	234
8.1.3. Assigning Properties.....	248
8.1.4. Assigning Supports.....	249
8.1.5. Assigning Loads	253
8.1.6. Solving.....	257
8.1.7. Viewing and Printing Results.....	260

8.2. Example 2 - Cantilever Retaining Wall	266
8.2.1. Problem Formulation.....	266
8.2.2. Preparing the Input	268
8.2.3. Assigning Properties.....	282
8.2.4. Assigning Supports.....	285
8.2.5. Assigning Loads	287
8.2.6. Solving.....	290
8.2.7. Viewing and Printing Results.....	293

Chapter: APPENDIX

A.1. Default Load Case and Combination Factors.....	300
A.1.1. For ACI 318-14/11	303
A.1.2. For ACI 318-08/05	305
A.1.3. For ACI 318-02	307
A.1.4. For CSA A23.3-14/04/94	309
A.2. Import File Formats.....	313
A.2.1. Grid Data	313
A.2.2. Load Data	314
A.2.3. Load Combination Data	315
A.3. Conversion Factors – English to SI.....	316
A.4. Conversion Factors – SI to English.....	317
A.5. Material Strength Value Limits.....	318
A.6. Contact Information	319

CHAPTER

1

INTRODUCTION

spWall is structural engineering software for the analysis and design of reinforced concrete cast-in-place shear walls, tilt-up walls, retaining walls, tank walls, and precast architectural and load-bearing panels. It uses a graphical interface that enables the user to easily generate complex concrete wall models. The geometry of the wall including openings and stiffeners, the material properties, the loads (point, line, and area), and the support conditions including translational and rotational springs are assigned graphically by the user at any node.

The program is based on the finite element method and can take into account second-order effects. The wall may include any number of openings and stiffeners. The amount of steel reinforcement required for flexure is computed based on the selected design standard, and the user can specify one or two layers of reinforcement. The program also calculates the amount of steel required for shear and torsion in the stiffeners. The wall shear strength provided by concrete (in-plane and out-of-plane) is calculated allowing the user to determine the need for adding shear capacity.

1.1. Program Features

- Code support for ACI 318-14, ACI 318-11, ACI 318-08, ACI 318-05, and ACI 318-02
- Code support for CSA A23.3-14, CSA A23.3-04, and CSA A23.3-94
- English (U.S.) and Metric (SI) unit systems
- Finite element analysis (including second order effects) of flat wall panels with stiffeners
- Four-noded, prismatic, thin plate wall element with six degrees-of-freedom per node
- Two-noded, stiffener element with six degrees-of-freedom per node
- Support for multiple material properties (concrete and reinforcing steel) for different plate and stiffener elements
- Design moments include the contribution of twisting moments
- Object-based modeling of wall systems with a full featured graphical interface
- Templates of predefined and loaded models allowing the user to select and generate quick models for shear walls, precast walls, tilt-up walls, tank walls, retaining walls, deep beams and transfer girders.
- Default definitions and assignment of model properties to facilitate model development
- Structural grids to facilitate structural member placement from elevation
- Support for irregular geometry of wall panels which may also include openings
- Null stiffeners to support the application of uniform line loads and linear restraints
- Ability to apply linear and nodal restraints and nodal springs in any of the 6 degrees of freedom provided
- Point, uniform line, uniform area, and linear area load types to model typical wall loading conditions
- Load combinations categorized into service (serviceability) and ultimate (design) levels
- Automatic computation of wall and stiffener object self-weights with the option to include or exclude them in the analysis
- Automatic mesh generation with the ability to specify maximum allowed mesh size, maximum allowed aspect ratio and number of circle segments
- Isometric (3D) view of the modeled wall with ability to view grids, loads and other model features in typical CAD environment in multi viewports with up to 6 concurrent views
- Data validation during input

- Contour plots and force diagrams to visualize the analysis and design results
- Calculation of wall shear strength provided by concrete (in-plane and out-of-plane) accordance with ACI code
- Calculation of wall cross-sectional forces in horizontal sections along wall height
- Design of wall flexure and axial reinforcement with one or two reinforcement curtains
- Design of stiffener elements for flexure, shear, and torsion
- Print/Export module for viewing, customizing, and exporting screenshots
- Tables module for viewing and exporting input and output data
- Reporter module for customizing, generating, viewing, exporting, and printing results
- Import and export of grids, loads, and load cases & load combinations information from and to text files to facilitate model generation
- User-controlled screen display settings including a full color palette
- Smart snap assist features for improved modeling speed and accuracy
- Ability to save defaults and settings for future input sessions

1.2. Program Capacity

- 100 X-grid lines
- 100 Y-grid lines
- 1000 Nodes in total
- 25 Nodes per linear generation
- 36 Nodes per circular generation
- 24, 36, 48 Circle segments for meshing circular foundations
- 255 Plate definitions
- 255 Stiffener section definitions
- 255 Plate cracking coefficient definitions
- 255 Stiffener cracking coefficient definitions
- 255 Plate design criteria definitions
- 255 Stiffener design criteria definitions
- 255 Concrete definitions
- 255 Reinforcement definitions
- 255 Support definitions
- 255 Nodal spring definitions
- 26 Load cases
- 255 Load combinations (service plus ultimate)
- 10,000 Mesh elements

1.3. System Installation Requirements

Any computer running Microsoft Windows 10 or Windows 11 operating system is sufficient to run the spWall program provided that .NET Framework v4.8 is installed. If it is not detected by the installation program, then it will be installed automatically.

The actual program capacity depends on system resources available on the computer on which spWall is running. To solve models with the maximum number of nodes and load combinations, a 64-bit operating system with at least 8GB of RAM is required. It is recommended to run the model on the local computer hard drive for fastest response.

For instructions on how to purchase, download, install, license, and troubleshoot issues, please refer to support pages on the StructurePoint website at [StructurePoint.org](https://www.structurepoint.org).

1.4. Terms & Conventions

The following terms are used throughout this manual. A brief explanation is given to help familiarize you with them.

Windows	refers to the Microsoft Windows environment as listed in System Requirements.
[]	indicates metric equivalent.
Click on	means to position the cursor on top of a designated item or location and press and release the left-mouse button (unless instructed to use the right-mouse button).
Double-click on	means to position the cursor on top of a designated item or location and press and release the left-mouse button twice in quick succession.
Marquee select	means to depress the mouse button and continue to hold it down while moving the mouse. As you drag the mouse, a rectangle (known as a marquee) follows the cursor. Release the mouse button and the area inside the marquee is selected.

Various styles of text and layout have been used in this manual to help differentiate between different kinds of information. The styles and layout are explained below

<i>Italic</i>	indicates a glossary item, or emphasizes a given word or phrase.
Bold	All bold typeface makes reference to either a menu or a menu item command such as File or Save , or a tab such as Description or Grid .
Mono-space	indicates something you should enter with the keyboard. For example type “c:\filename.txt”.
KEY + KEY	indicates a key combination. The plus sign indicates that you should press and hold the first key while pressing the second key, then release both keys. For example, “ALT + F” indicates that you should press the “ALT” key and hold it while you press the “F” key. Then release both keys.
SMALL CAPS	Indicates the name of an object such as a dialog box or a dialog box component. For example, the OPEN dialog box or the CANCEL or MODIFY buttons.

CHAPTER

2

SOLUTION METHODS

2.1. Introduction

spWall uses the Finite Element Analysis (FEA) Method for the structural modeling and analysis of slender and non-slender reinforced concrete walls subject to static loading conditions.

The wall is idealized as a mesh of rectangular plate elements and straight-line stiffener elements. Walls of irregular geometry are idealized to conform to geometry with rectangular boundaries. Even though plate and stiffener properties can vary between elements, they are assumed uniform within each element.

The six degrees of freedom considered at each node are the three translations and three rotations relating to the three Cartesian axes. An external load can exist in the direction of each of the degrees of freedom, i.e., three forces and three moments about the Cartesian axes. Sufficient number of nodal degrees of freedom should be restrained in order to achieve stability of the model.

The program assembles the global stiffness matrix and load vectors for the finite element model. Then, it solves the equilibrium equations to obtain deflections and rotations at each node. Finally, the program calculates the internal forces and internal moments in each element. At the user's option, the program can perform second order analysis. In this case, the program takes into account the effect of in-plane forces on the out-of-plane deflection.

Walls can be designed using simplified methods such as the empirical design method and alternative method provided in ACI 318 and CSA A23.3 standards¹. Such methods are limited to specific wall geometry, section attributes, loading configuration, and support conditions. Walls that do not meet these limitations are required to be designed as compression members² and slenderness effects in them can be accounted for by performing second-order analysis³. This general approach is implemented in spWall to allow for a wider range of wall configurations and applications.

The program calculates the required amount of reinforcement in the plate elements and stiffener elements based on the code selected by the user. For solid walls, spWall can also compare cross-sectional shear forces with calculated in-plane and out-of-plane shear strength provided by concrete. User can use this information to determine the need for additional shear strength and finalize the reinforcement distribution and detailing.

¹ ACI 318-14, 11.5.3, 11.4, 11.8; ACI 318-11, 14.5, 14.8; ACI 318-08, 14.5, 14.8; ACI 318-05, 14.5, 14.8; ACI 318-02, 14.5, 14.8; CSA A23.3-14, 14.2.2, 23.3; CSA A23.3-04, 14.2.2, 23.3; CSA A23.3-94, 14.5, 23.4

² ACI 318-14, 11.5.2.1; ACI 318-11, 14.4; ACI 318-08, 14.4; ACI 318-05, 14.4; ACI 318-02, 14.4; CSA A23.3-14, 14.2.1; CSA A23.3-04, 14.2.1; CSA A23.3-94, 14.4

³ ACI 318-14, 6.7.1.1; ACI 318-11, 10.10.4; ACI 318-08, 10.10.4; ACI 318-05, 10.10.1; ACI 318-02, 10.10.1; CSA A23.3-14, 10.13.1; CSA A23.3-04, 10.13.1; CSA A23.3-94, 10.13.1

2.1.1. Wall Systems

spWall can be used to model, analyze, and design wall systems such as shear walls, bearing walls, precast walls, tilt-Up walls, tank walls, retaining walls, and deep beams (also known as transfer girders). Samples of such systems are illustrated below:

Shear Walls

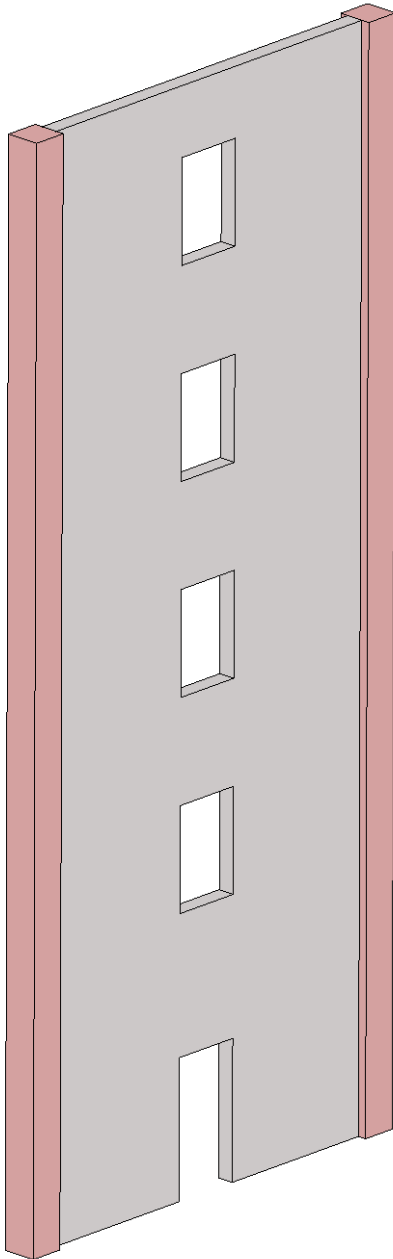

Bearing Walls

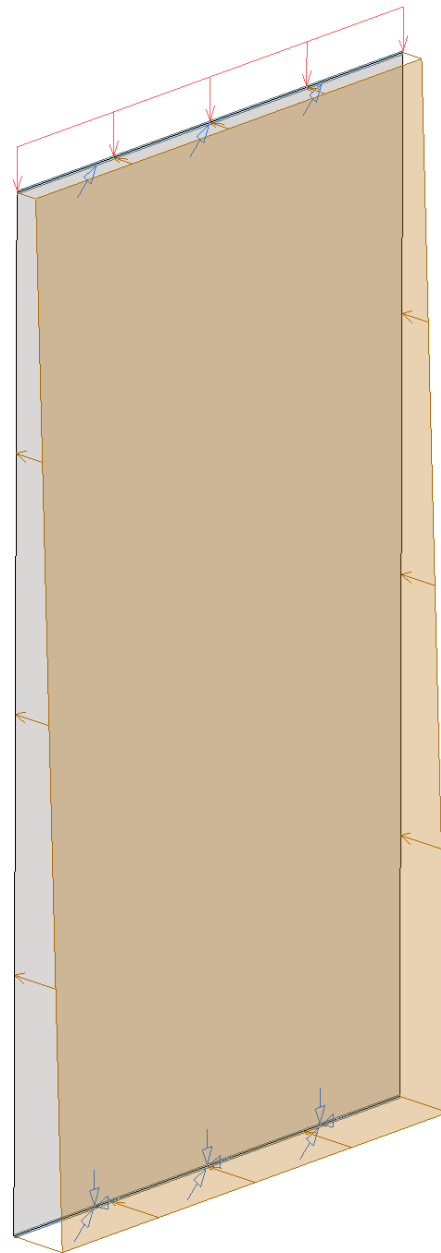

Precast Walls

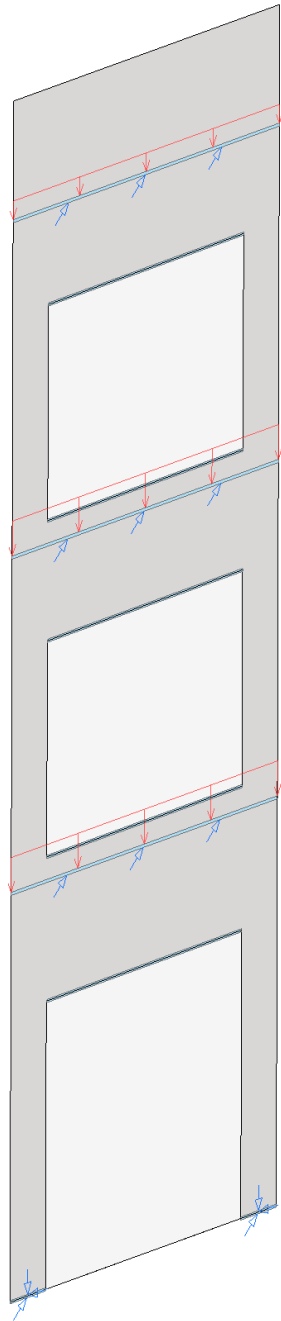

Tilt Up Walls

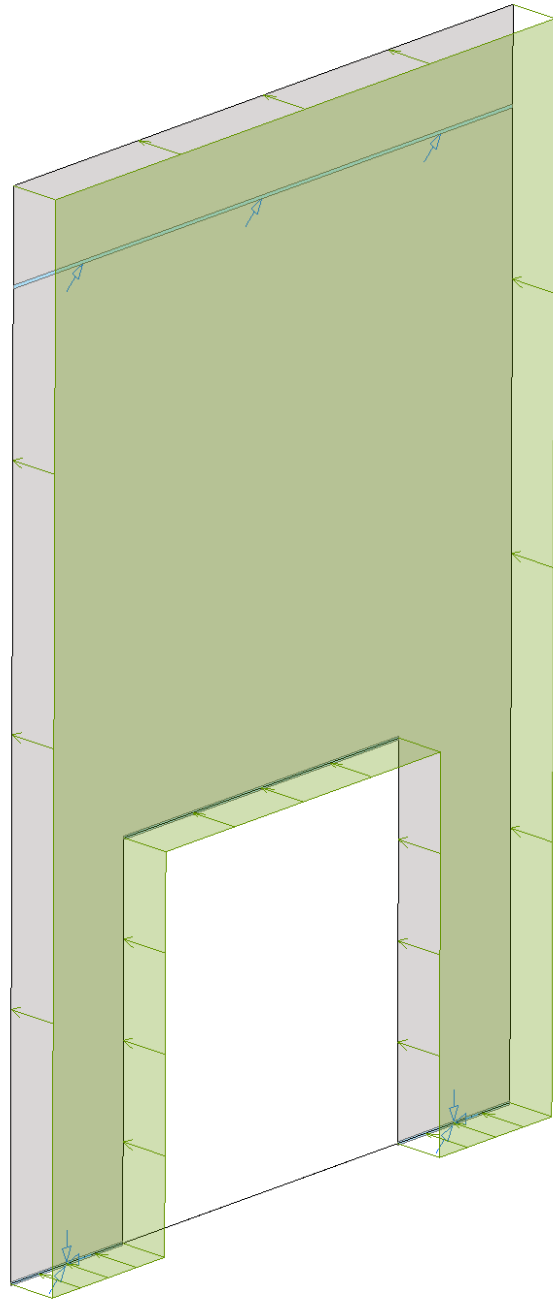

Tanks & Retaining Walls

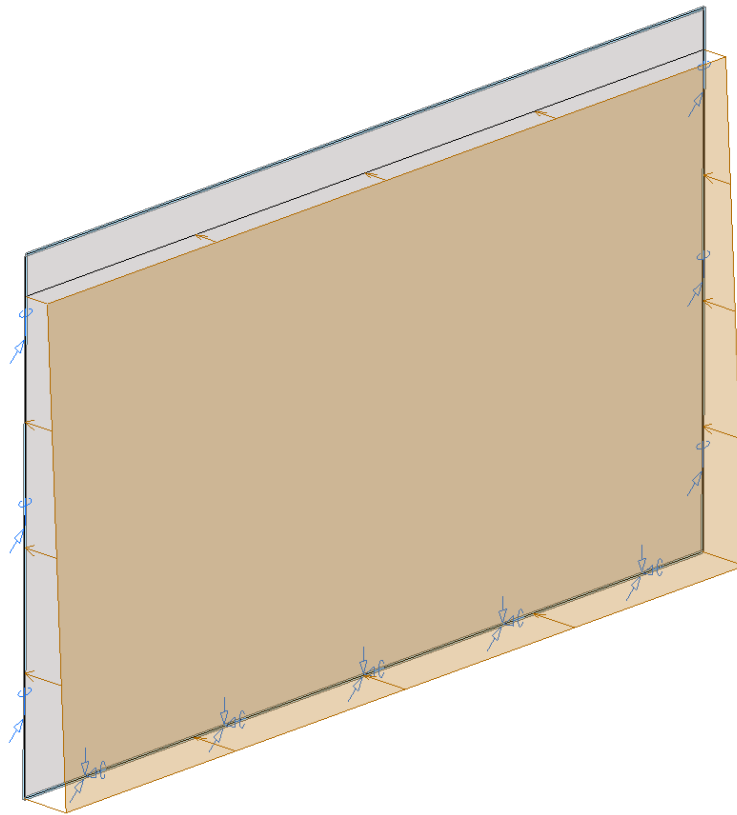

Deep Beams / Transfer Girders

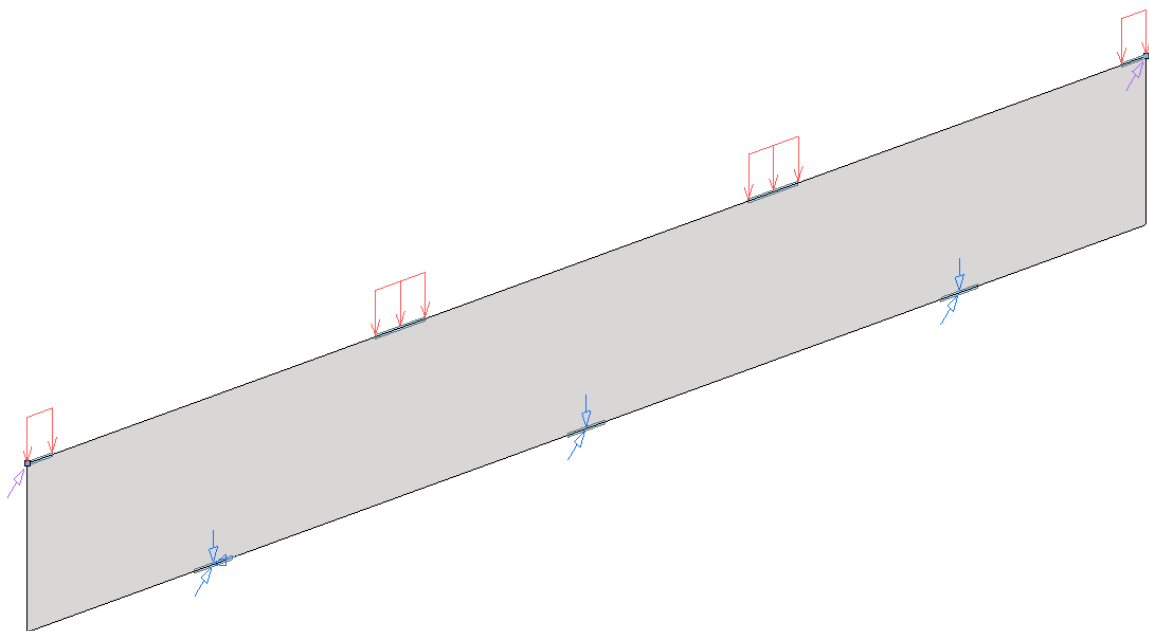

2.1.2. Coordinate Systems

Global Coordinate System

The mid-surface of the wall lies in the XY plane of the right-handed XYZ rectangular coordinate system shown in [Figure 2.1](#). The wall thickness is measured in the direction of the Z-axis. The positive X-axis points to the right, the positive Y-axis points upward towards the top of the monitor, and positive Z-axis points out of the screen. Thus, the XY plane is defined as being in the plane of the display monitor.

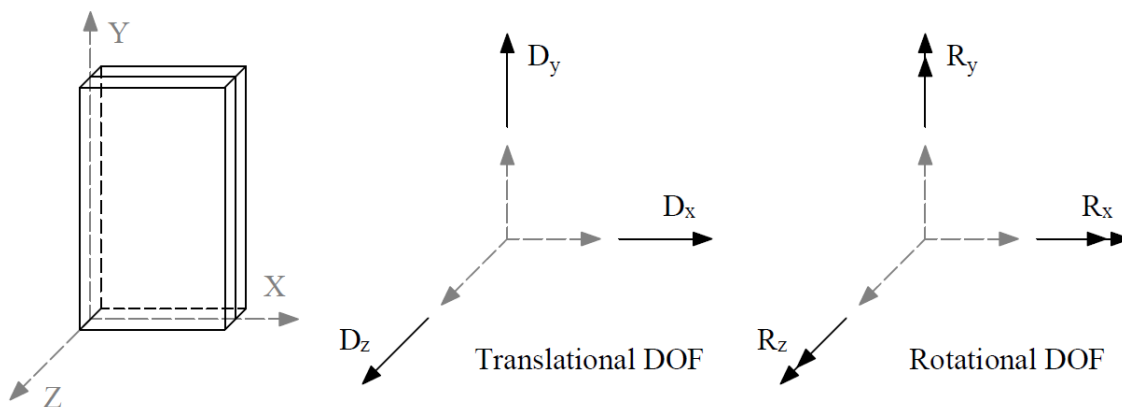

Figure 2.1 – Global Coordinate System

Local Coordinate System

While the local and global coordinate systems are the same for plate elements and horizontal stiffeners, the vertical stiffeners local coordinate system is different from the global. Refer to [Figure 2.2](#) and [Figure 2.3](#) for more information.

2.2. Codes and Standards Provisions

2.2.1. Code Checks

2.2.1.1. Geometry Considerations

The program does not have any code checks regarding geometry considerations. For factory cast precast or site cast precast (tilt-up) concrete walls incorporating a insulation layer, sometimes referred to as sandwich panels, user need to consider such geometry in detail. Where the sandwich panel is composed of a structural wythe and an architectural wythe, additional selfweight of non-structural wall elements can either be modeled as part of the wall geometry or simply applied as additional dead load.

In wall systems where architectural detail features are required such as reveals and rustication strips in tilt-up construction, the location of steel reinforcement is recessed. This condition must be addressed by the user by setting the cover distance to account for the loss of reinforcement cover resulting from the installation of reveal strips in concrete formwork.

Deflection limits may be required by certain code provisions to control the primary (first-order) and/or secondary (second-order) displacements of concrete walls. This issue is of particular importance to slender wall subject to out-of-plane lateral loads. spWall provides a displacement limit in the solver menu to aid the user in detecting deflections beyond a desirable limit.

2.2.1.2. Material Considerations

The program provides default material properties for common grades of steel and concrete materials used in customary construction of wall systems. For some input parameters, the user may exercise the option to waive selected code minimum or maximum values to examine unique conditions or as-built scenarios that can benefit for the removal of preset limits.

2.2.1.3. Loading Considerations

Each load is applied to the wall under one of the 26 (A through Z) load cases. The wall is analyzed and designed under load combinations. A load combination is the algebraic sum of each of the load cases multiplied by a load factor.

Load combinations are categorized into service-level and ultimate-level. For each service-level and ultimate-level load combinations, nodal displacement, internal forces in plate and stiffener elements, and reactions are calculated. Additionally, wall cross-sectional forces are calculated for ultimate-level load combinations. The output is available only when solution criteria are met for all load combinations.

For the design of reinforced concrete elements, the required area of steel is calculated due to the element internal forces from the ultimate level combinations. On the other hand, displacement envelopes are determined using the displacement from the service level combinations.

Basic load cases and the corresponding load factors for service and ultimate load combinations are provided as defaults in the input file templates (activated in SETTINGS / STARTUP DEFAULTS) to facilitate user's input. The default load cases and load combination factors should be modified as necessary at the discretion of the user.

Given the numerous applications of spWall to structural wall systems including liquid containing, soil retaining, cast in place, and precast systems, the load combinations must be examined in detail to consider the myriad of possible conditions that can exist. A detailed discussion of load case and combination factors is provided in [Appendix A.1](#).

2.2.2. Geometry Checks

Input Phase

The Program ensures that nodes with assigned properties exist within an element. If a node with properties such as restraints or loads is not attached to an element, the following Error message is displayed.

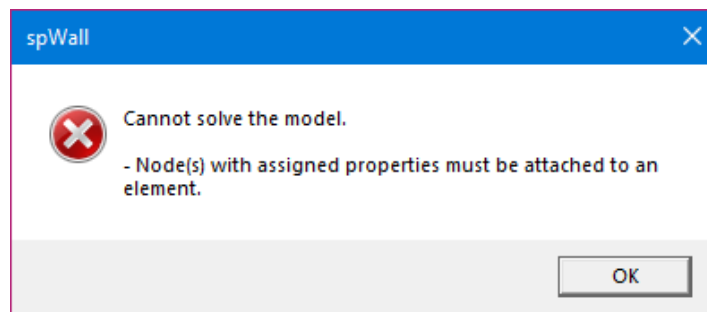

The Program also ensures that null stiffener elements exist within a plate element. If a null stiffener is placed outside the plate element, the following Error message is displayed.

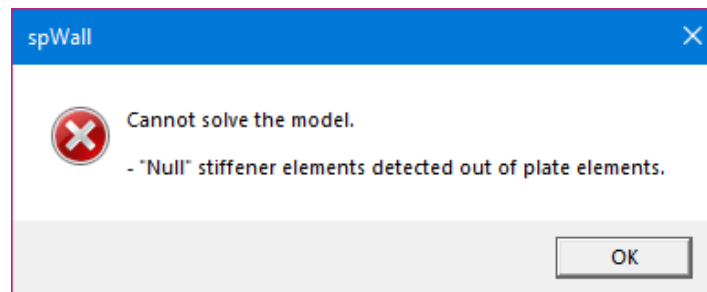

Output Phase

There are no geometric checks performed by the Program during output phase. However, any warning pertaining to model stability or exceedance of limits is reported. Detailed information on the solution can be found in the **Solver Messages** Dialog under **Tables** Window.

2.2.3. Definitions and Assumptions

The analysis of the reinforced concrete members performed by spWall conforms to the provisions of the Strength Design Method and Unified Design Provisions and is based on the following basic assumptions:

- All conditions of strength satisfy the applicable conditions of equilibrium and strain compatibility
- Strain in the concrete and in the reinforcement is directly proportional to the distance from the neutral axis. In other words, plane sections normal to the axis of bending are assumed to remain plane after bending.
- An equivalent uniform rectangular concrete stress block is used with a maximum usable ultimate strain at the extreme concrete compression fiber equal to 0.003 for ACI codes and 0.0035 for CSA codes
- Tensile strength of concrete in axial and flexural calculations is neglected
- For reinforcing steel, the elastic-plastic stress-strain distribution is used
- The required reinforcement is determined based on the combined effect of axial force and biaxial bending for model elements
- Assumptions related to the plate and stiffener elements used in the finite element analysis method are outlined in [Section 2.3](#).
- Detailed provisions and equations for the design codes and unit systems supported by spWall are outlined in [Section 2.7](#).

2.3. Analysis Methods

2.3.1. Overview of Finite Element Method (FEM) of Analysis

As introduced in [Section 2.1](#), the finite element method is used in spWall for structural analysis of walls. During analysis, spWall converts the object-based model into a finite element model. The user defines the mesh used in the finite element analysis by inputting maximum allowed mesh size and maximum allowed aspect ratio. Additional meshing is automatically introduced at plate boundaries, stiffeners, and nodes with assigned properties such as restraints and point loads.

2.3.1.1. Plate Element

The rectangular plate finite element has four nodes, one at each corner, as shown in [Figure 2.2](#). Each node has six degrees of freedom (D_x , D_y , D_z , R_x , R_y , and R_z). The rotation, R_z , is referred to as the drilling rotation⁴.

The plate element combines the membrane (in plane) and bending (out of plane) actions. Element stiffness is calculated based on the following assumptions:

1. The x-y plane is the mid surface of the plate element.
2. Deformations are small and the resulting displacements do not significantly change the geometry of the wall.
3. The membrane and bending deformations are uncoupled.
4. Bending behavior follows the thin plate theory (Kirchhoff theory).
5. Plane sections initially normal to the mid-surface remain plane and normal to that surface after bending.

⁴ [Reference \[9\]](#)

6. The stress component normal to the mid-plane is small compared to other stress components and is neglected.
7. The plate element material is homogeneous, elastic, isotropic, and obeys Hooke's law.

If second order analysis is requested, the stiffness terms related to the bending action are modified to include the effect of in-plane internal forces⁵.

When locating reinforcement within a plate element, the program refers to the left face and right face. The left face of the panel is defined as the face to the left of the plate centerline when looking along the positive X-axis. See [Figure 2.2](#).

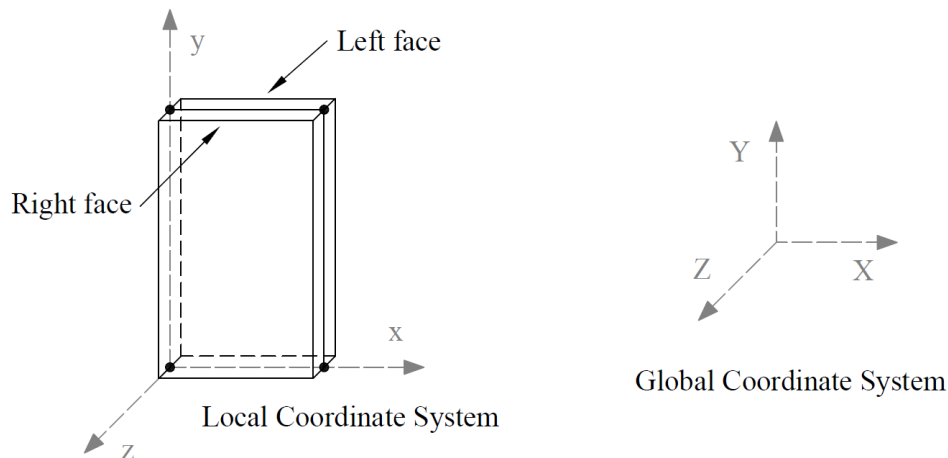

Figure 2.2 – Plate Element

⁵ [Reference \[9\]](#)

2.3.1.2. Stiffener Element

Stiffener elements can be used to model beams or columns that are embedded in the wall to increase its structural capacity, e.g. lintels, pilasters, and boundary elements of shear walls. Wall piers that are required to be designed as columns can also be modeled using stiffeners.

Additionally, isolated stiffener elements placed outside of the wall can model rigid frame structures attached to the wall. The program will calculate internal forces in the stiffener elements and calculate the area of reinforcement required for axial action combined with biaxial bending as well as shear and torsion.

The stiffener element used in the program has two nodes, one at each end, as shown in [Figure 2.3](#). Each node has six degrees of freedom (D_x , D_y , D_z , R_x , R_y , and R_z). Element stiffness is calculated based on the following assumptions:

1. The local x-axis passes through the element centroid.
2. Deformations are small and the resulting displacements do not significantly change the geometry of the wall.
3. Axial and bending deformations are uncoupled.
4. Plane sections initially normal to the element axis remain plane and normal to that axis after bending.
5. The stiffener element material is homogeneous, elastic, isotropic, and obeys Hooke's law.

If second order analysis is requested, the stiffness terms related to the bending about the y-axis are modified to include the effect of the axial force⁶.

⁶ [Reference \[10\]](#)

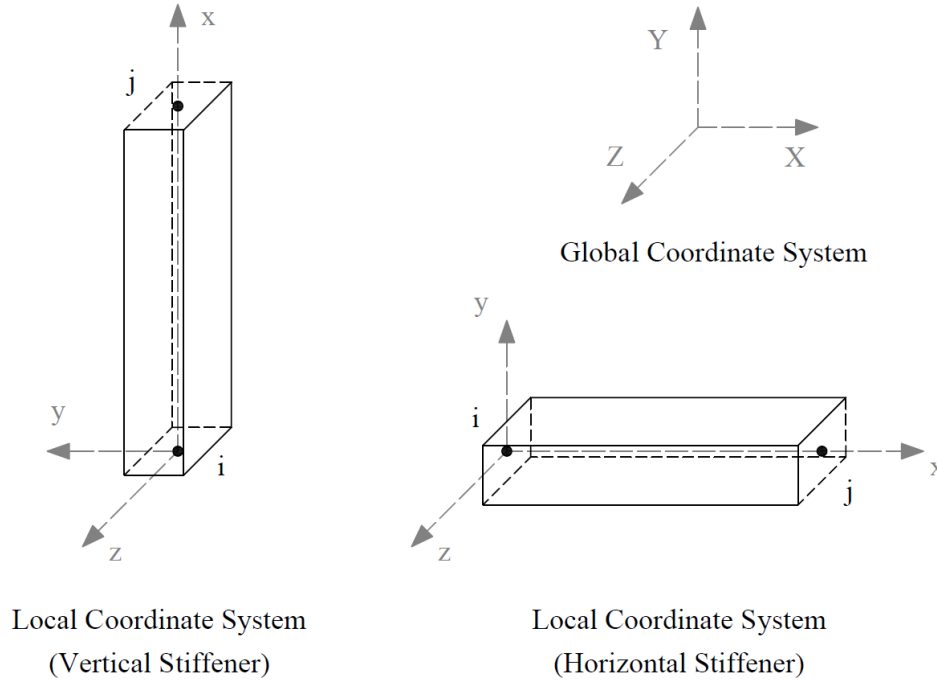

Figure 2.3 – Stiffener Element

The properties of the stiffener section, area (A), Inertia (I_y , I_z) and torsional constant (J) are calculated as follows

$$A = \begin{cases} b \times h & \text{rectangular section} \\ \pi \times D^2 & \text{circular section} \end{cases}$$

I_y = Inertia of the web and the flanges about the centroidal local y-axis.

$$I_z = \begin{cases} \frac{h \times b^3}{12} & \text{rectangular section} \\ \frac{\pi \times D^4}{64} & \text{circular section} \end{cases}$$

$$J = \frac{w_{fl} t_{fl}^3}{3} + \frac{w_{fr} t_{fr}^3}{3} + \begin{cases} \frac{b \times h^3}{3} (b > h) & \text{rectangular section} \\ \frac{h \times b^3}{3} (h > b) & \text{rectangular section} \\ \frac{\pi \times D^4}{32} & \text{circular section} \end{cases}$$

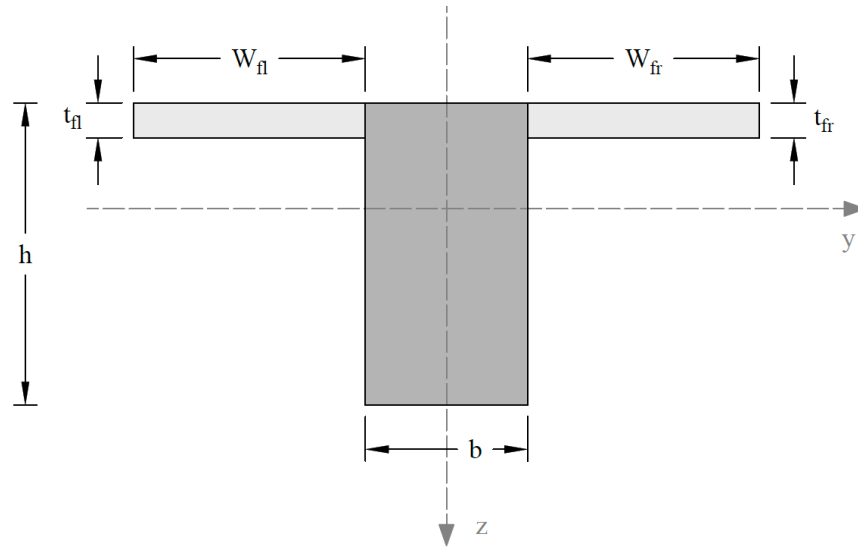

Figure 2.4 shows the elevation and views of a sample wall.

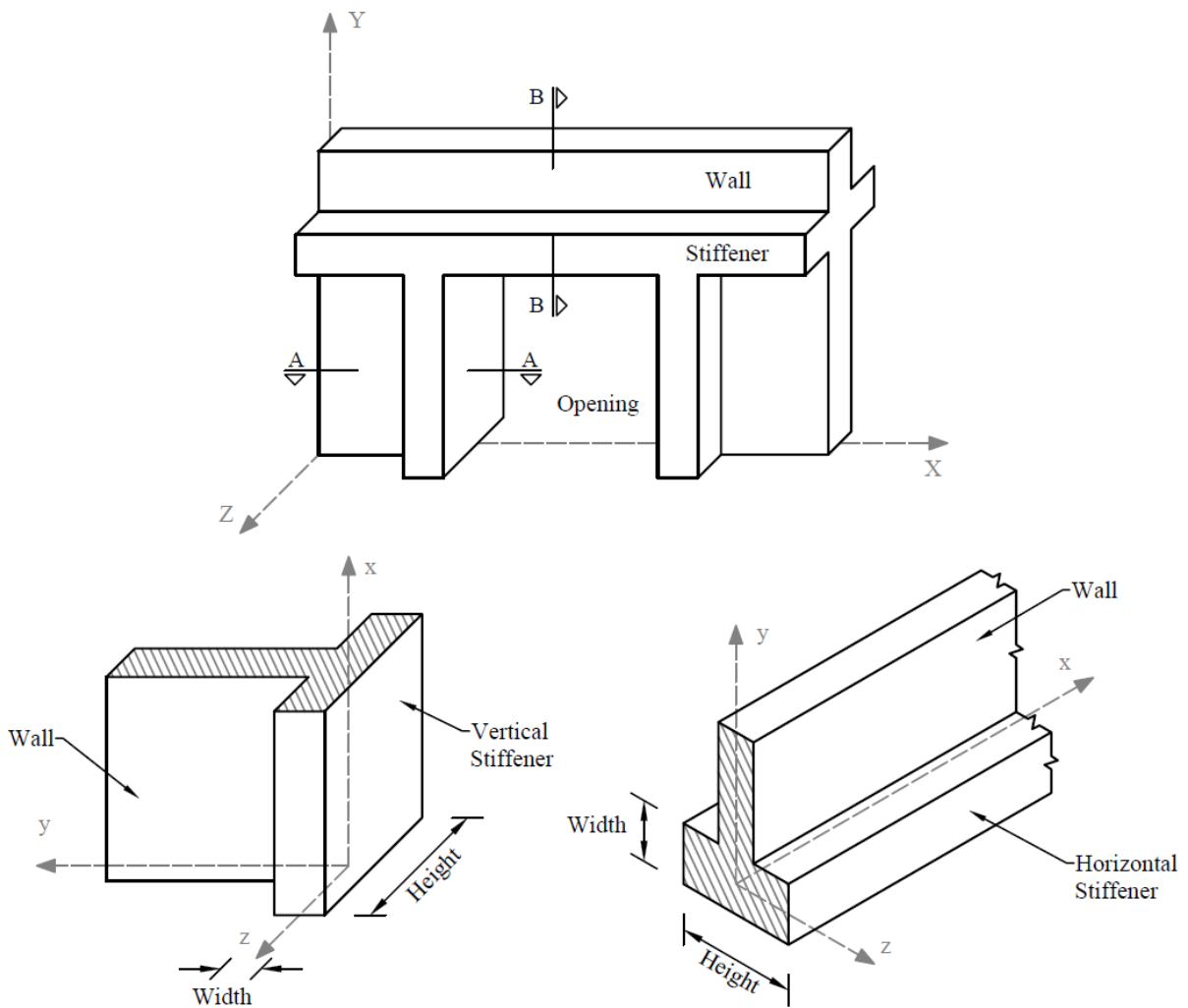

Figure 2.4 – Wall Elevation and Sections

2.3.2. Modeling of Supports

2.3.2.1. Nodal Restraints

All nodal degrees-of-freedom (DOF) are assumed to be initially released (i.e. free to move). Mathematically speaking, each DOF implies an equilibrium equation; however, nodal DOF may be fully restrained against displacement and/or rotation. This allows the definition of wall supports. For equilibrium to exist, the wall must be restrained such that structure stability is achieved.

2.3.2.2. Nodal Springs

Nodal DOF can be partially restrained by defining spring supports. Spring constants corresponding to the six DOF can be defined at any node. The spring supports are idealized as linear springs. Units of the spring constant are in terms of force per unit length for translational springs and moment per radian for rotational springs.

2.3.3. Modeling of Loads

An external load is applied as a point load, a line load, or an area load. Positive forces are defined as forces in the positive direction of the global axes, and positive moments are defined in accordance with the right-hand rule. In other words, if the thumb of your right-hand points in the positive direction of an axis, curling the rest of your right-hand fingers defines the positive moment about that axis.

2.3.3.1. Point Loads

A point load consists of three forces P_x , P_y , and P_z and three moments M_x , M_y , and M_z corresponding to the six DOF at each node. Point forces have units of force, and point moments have units of force times length. Point forces and point moments must be applied at a node. In addition to point moments, an eccentricity in the Z-direction, E_z , can be input. P_x and P_y values are multiplied by E_z to obtain additional point moments (Figure 2.5). Thus, the final moments at a node are

$$M_x = \bar{M}_x - E_z P_y \quad \text{and} \quad M_y = \bar{M}_y - E_z P_x,$$

where \bar{M}_x and \bar{M}_y are the moment input by the user about the X and the Y axes respectively.

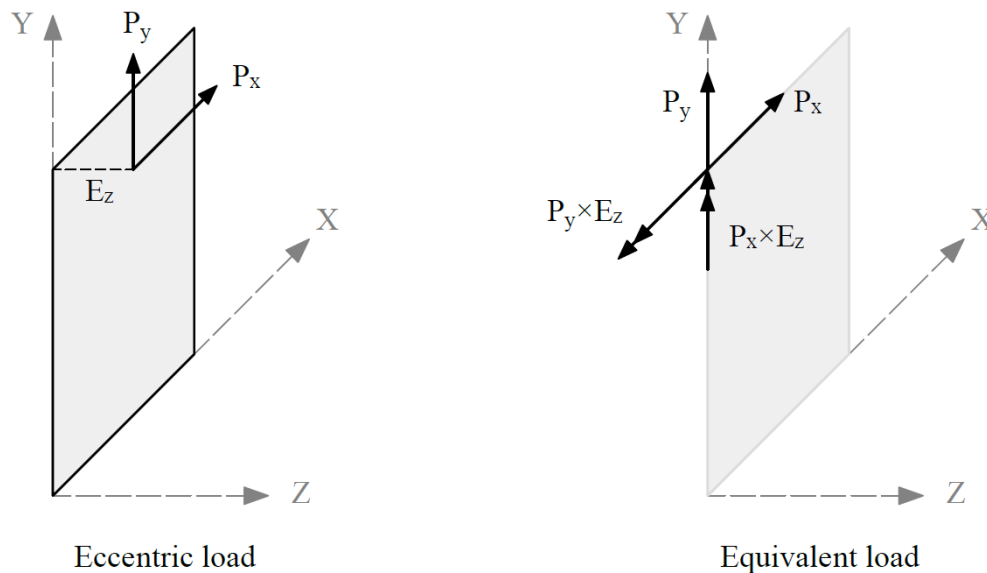

Figure 2.5 – Eccentric Point Load

Eccentricity of the load can also account for wall's deviation from plumb that is either measured or assumed based for example on specifications for tolerances⁷.

2.3.3.2. Line Load

A line load consists of three uniformly distributed line loads W_x , W_y , and W_z corresponding to the three translational DOF at each node and an eccentricity in the Z-direction, E_z . Line loads must be applied along the boundary of a plate element or along a stiffener element. W_x , W_y , and W_z have units of force per unit length. Internally in the program, lumped-nodal loads replace the line load as follows (Figure 2.6).

$$\begin{Bmatrix} P_x \\ P_y \\ P_z \end{Bmatrix} = \frac{L}{2} \begin{Bmatrix} W_x \\ W_y \\ W_z \end{Bmatrix}$$

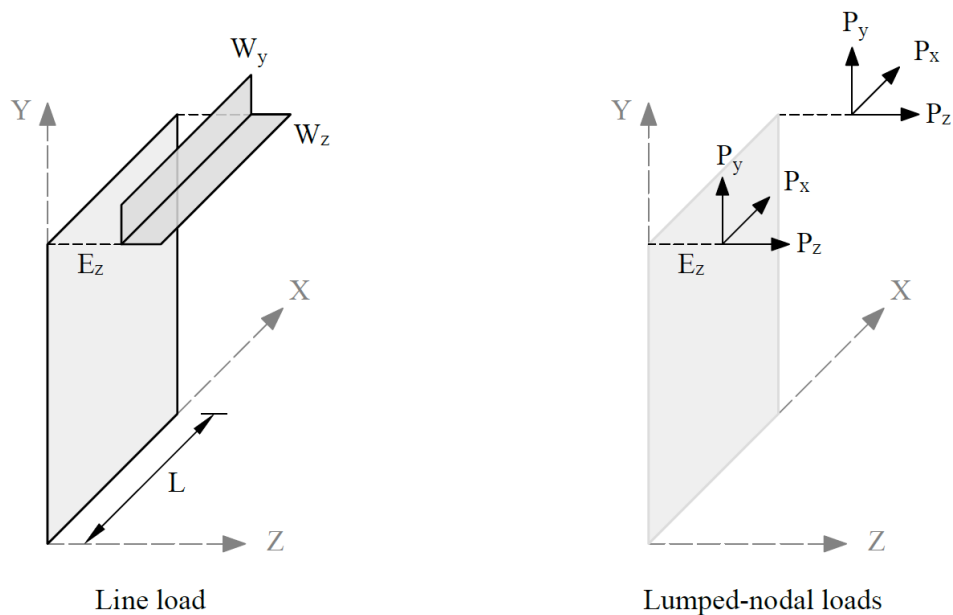

Figure 2.6 – Line Load

⁷ See deviation from plumb in ACI 117-06, 4.1

2.3.3.3. Uniform Area Loads

A uniform area load consists of three uniformly distributed loads, W_x , W_y and W_z corresponding to the three translational DOF. Area loads are applied over the area of plate elements. W_x , W_y and W_z have units of force per unit area. Internally in the program, lumped-nodal loads replace the uniform area load as follows (Figure 2.7).

$$\begin{Bmatrix} P_x \\ P_y \\ P_z \end{Bmatrix} = \frac{ab}{4} \begin{Bmatrix} W_x \\ W_y \\ W_z \end{Bmatrix}$$

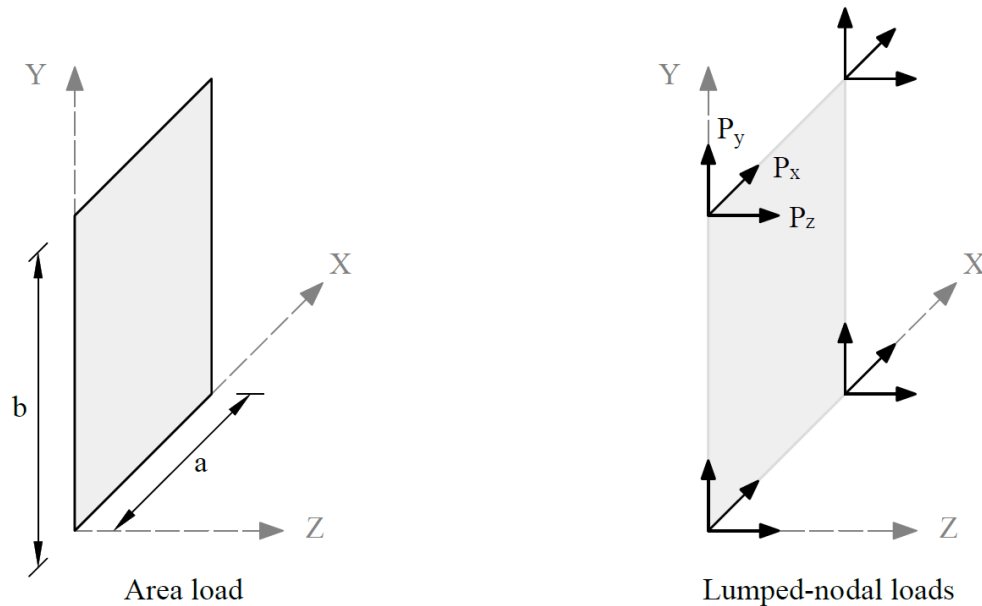

Figure 2.7 – Area Load

2.3.3.4. Linear Area Loads

Linear area loads are used to represent water and earth pressure. The load is defined as linearly varying in the Y direction and uniform in the X direction (Figure 2.8). The load values are defined at two points, along the Y-direction, whose Y-coordinates are denoted Y_1 and Y_2 respectively. The load values are denoted W_{x1} , W_{y1} , and W_{z1} at Y_1 while they are denoted W_{x2} , W_{y2} , and W_{z2} at Y_2 .

The load is applied to an element as uniform area load intensity of which is calculated as follows:

$$\begin{Bmatrix} W_x \\ W_y \\ W_z \end{Bmatrix} = \frac{(Y_2 - Y)}{(Y_2 - Y_1)} \begin{Bmatrix} W_{x1} \\ W_{y1} \\ W_{z1} \end{Bmatrix} + \frac{(Y - Y_1)}{(Y_2 - Y_1)} \begin{Bmatrix} W_{x2} \\ W_{y2} \\ W_{z2} \end{Bmatrix}$$

Where Y is the Y-coordinate of the element center.

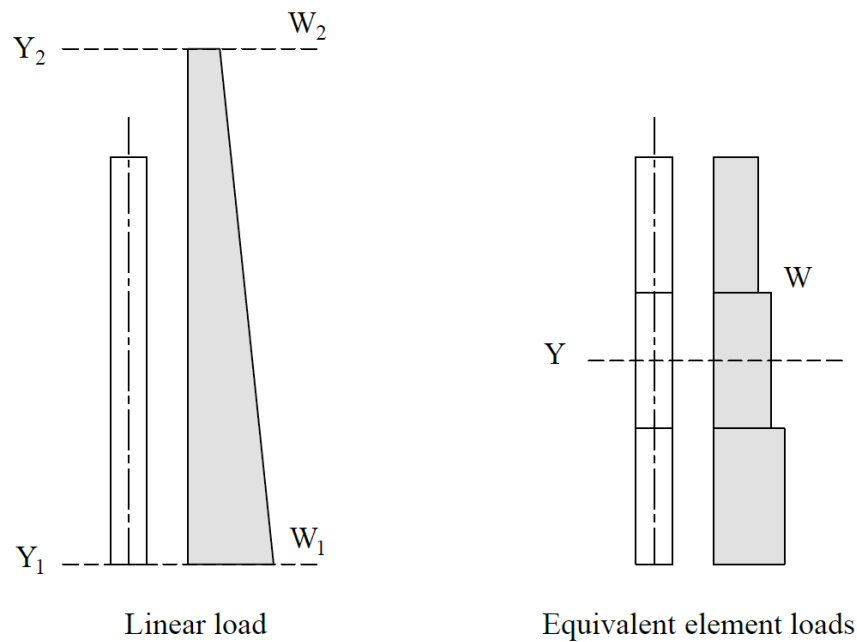

Figure 2.8 – Linear Area Load

2.3.3.5. Self-Weight

The self-weight of the wall is computed internally based on the concrete unit weight and the thickness of each plate element or volume of each stiffener element. For plate elements, the value of self-weight is applied as a uniform area load in the Y-direction. For stiffener element, the value of self-weight is applied as a uniform line load in the Y-direction. The self-weight may optionally be included in the analysis in load case A.

2.3.4. Displacement and Stability - Cracking Coefficients

To account for cracking of elements, the user can input cracking coefficient values for plate and stiffener elements to effectively reduce stiffness. Cracking coefficients for out-of-plane (bending and torsion) and in-plane (axial and shear) stiffness can be entered for plate elements. Cracking coefficients for A , I_z , I_y , and J can be entered for stiffeners. Because the values of the cracking coefficients can have a large effect on the analysis and design results, the user must take care in selecting values that best represent the state of cracking at the particular loading stage. Cracking coefficients are greater than 0 and less than or equal to 1.

At ultimate loads, a wall is normally in a highly cracked state. The user could enter a value for out-of-plane cracking coefficient for plates and I_z and I_y cracking coefficients for stiffeners of $I_{cracked} / I_{gross}$ based on estimated values of A_s . With an assumed value of A_s , $I_{cracked}$ can be calculated using the following formula⁸.

$$I_{cracked} = \frac{b \times c^3}{3} + \frac{E_s}{E_c} A_{se} (d - c)^2$$

where

$$A_{se} = \begin{cases} A_s + \frac{P_u}{f_y} \left(\frac{h/2}{d} \right) & \text{ACI 318-14/11/08} \\ A_s + \frac{P_u}{f_y} & \text{ACI 318-05/02} \\ A_s & \text{CSA A23.3} \end{cases}$$

Refer to [Section 2.6.1](#) for additional information.

After the analysis and design, if the computed value of A_s greatly differs from the estimated value of A_s , the analysis should be performed again with new values for the crack coefficients⁹.

⁸ ACI 318-14, 11.8.3.1; ACI 318-11, 14.8.3; ACI 318-08, 14.8.3; ACI 318-05, 14.8.3; ACI 318-02, 14.8.3; CSA A23.3-14, 23.3.1.3; CSA A23.3-04, 23.3.1.3; CSA A23.3-94, 23.4.1.3

⁹ For the first approximation of the $I_{cracked}/I_{gross}$ ratio the user may also refer to: ACI 318-14, 6.6.3.1.1, 6.6.4.2, 6.7.1.3, 6.8.1.4; ACI 318-11, 10.10.4.1; ACI 318-08, 10.10.4.1, ACI 318-05, 10.11.1; ACI 318-02, 10.11.1, CSA A23.3-14, 10.14.1.2; CSA A23.3-04, 10.14.1.2; CSA A23.3-94 10.14.1

At service loads, a wall may or may not be in a highly cracked state. For service load deflection analysis, a problem should be modeled with an out-of-plane cracking coefficient for plates, and I_z and I_y cracking coefficients for stiffeners of $I_{effective} / I_{gross}$. $I_{effective}$ is a value between $I_{cracked}$ and I_{gross} . The value of $I_{effective}$ can be obtained from the following formula¹⁰.

$$I_{effective} = \left(\frac{M_{cr}}{M_s} \right)^3 I_{gross} + \left[1 - \left(\frac{M_{cr}}{M_s} \right)^3 \right] I_{cracked} \leq I_{gross}$$

¹⁰ ACI 318-14, 19.2.3.1, 24.2.3.5; ACI 318-11, 9.5.2.3; ACI 318-08, 9.5.2.3; ACI 318-05, 9.5.2.3; ACI 318-02, 9.5.2.3; CSA A23.3-14, 9.8.2.3; CSA A23.3-04, 9.8.2.3; CSA A23.3-94, 9.8.2.3

2.3.5. Analysis Solution and Results

2.3.5.1. Solution Process

The solution process is summarized in the following steps

- A. Perform in-plane analysis
 1. Compute the plate and stiffener element matrices related to the in-plane degrees of freedom (δ_x , δ_y , and θ_z).
 2. Assemble the in-plane global stiffness matrix, $[K_i]$.
 3. Combine the applied loads and form number of load vectors equal to the number of load combinations, $[F_i]$.
 4. Compute the displacement $[U_i]$, by solving the equilibrium equations.
 5. Compute the plate element in-plane forces N_{xx} , N_{yy} , and N_{xy} .
 6. Compute the stiffener element in-plane end forces F_x , F_y , and M_z .
 7. Compute the reaction forces F_x , F_y , and M_z at each restrained node.
- B. Perform out-of-plane analysis
 1. If first order analysis is requested, the out-of-plane analysis is done once for all load combinations in a similar way to that done for the in-plane analysis.
 2. Out-of-plane analysis gives
 - i. the displacements (δ_z , θ_x , and θ_y) at each node,
 - ii. the reaction forces F_z , M_x , and M_y at each restrained node,
 - iii. the plate element internal moments M_{xx} , M_{yy} , M_{xy} ,
 - iv. the stiffener element end forces F_z , M_x , and M_y .

3. If second order analysis is requested (the default setting), a complete analysis cycle is done for each load combination. In each cycle, the basic stiffness terms of plate elements are modified to account for the effect of membrane forces¹¹. For stiffener elements, the basic stiffness matrix is modified to account for the effect of axial forces¹².
- C. Compute envelopes for the displacements produced by all service load combinations.
 - D. For each plate and stiffener element, compute the area of steel required for resisting all ultimate load combinations. For plate elements, the required area of steel is calculated at the element center. For stiffener elements, the area of steel is calculated at each of the element ends. Then, the maximum value of area of steel is reported.

¹¹ [Reference \[9\]](#)

¹² [Reference \[10\]](#)

2.3.5.2. Solution Results

The program output is organized into tables that may be optionally viewed, printed, or sent to file. Furthermore, the tables may be fully or partially output for all or for only selected nodes, members, and load combinations.

Nodal Displacements

Nodal displacements D_x , D_y , and D_z are output for individual service and individual ultimate load combinations. Positive displacement is in the positive direction of the axes. If the user selects the option to check out-of-plane displacement against the maximum permissible value provided by the user, the program will perform the comparison and flag service displacement results where the permissible values are exceeded.

Reactions

Restraint and Nodal Spring reactions are output for individual service load and ultimate load combinations for nodes with specified restraints or nodal springs. Nodal translational reactions F_x , F_y , and F_z , and rotational reactions M_x , M_y , and M_z are output. Positive translational reactions are in the direction of the positive axes and positive moment reactions are determined using the right-hand rule. The program also reports the sum of forces and moments with respect to wall center of gravity for applied loads and reactions.

Element Internal Forces

For each plate element, internal forces N_{xx} , N_{yy} , N_{xy} , M_{xx} , M_{yy} and M_{xy} are output for individual service or ultimate load combination.

For each stiffener element, internal forces N , V_y , V_z , M_y , M_z and T_x are output for individual service or ultimate load combination.

Displacement Envelopes

Maximum nodal displacements D_x , D_y , and D_z from all service load combinations are output. The governing load combination is identified. Positive displacements are in the direction of the positive axes.

Element Reinforcement

For each plate element, the required areas of reinforcement A_{sx} and A_{sy} are computed based on the average moments per element and are output along with design forces and governing ultimate load combination. In both horizontal and vertical directions, the reported reinforcements is the total required area of steel per unit length. Half of the reported value applies to each curtain in models with two curtain layout.

If the area of vertical reinforcement for a plate element is greater than one percent (0.5 percent for CSA A23.3-14/04), the program indicated that ties are required for bars in compression. If the program reports that ties are required for a single curtain design, switching to two curtain design should be considered by the user.

For each stiffener element, the required area of longitudinal reinforcement for flexure and axial loads A_s , transverse reinforcement, A_v/s , required for shear and torsion, and torsional transverse reinforcement A_t/s and A_l are output along with the design forces and governing ultimate load combination. Area of transverse reinforcement required for shear only can be calculated by subtracting twice the torsional reinforcement area from the area required for both shear and torsion.

Wall Cross-Sectional Forces

The program reports values of cross-sectional forces (N_{uy} , V_{ux} , V_{uz} , M_{ux} , M_{uy} , M_{uz}) at entire wall sections directly above (+) and directly below (–) each horizontal grid line level. The cross-sectional forces are calculated as sums of all corresponding forces or moments (with respect to cross-section centroid) applied as loads or reactions on one side of the section less forces and moments transferred by stiffeners if the wall section intersects any.

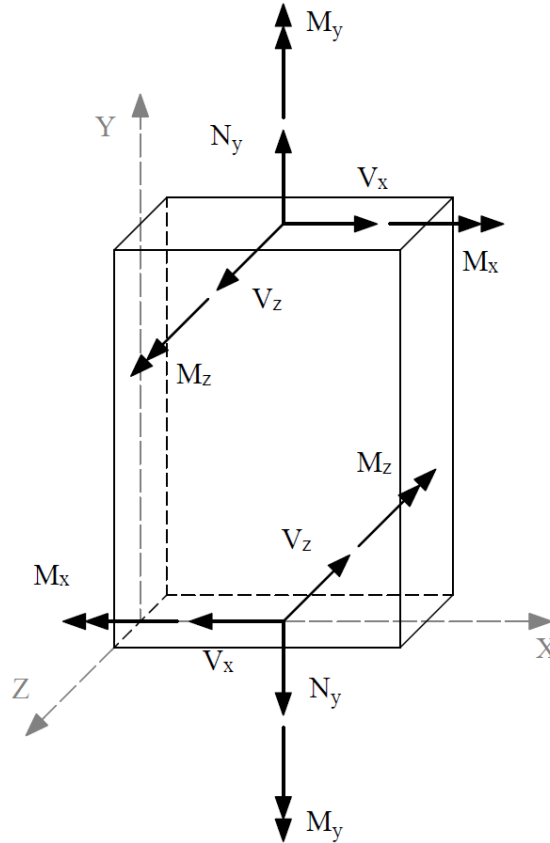

Figure 2.9 – Wall Cross-sectional Forces

The wall cross-sectional forces are used by the program to determine wall shear strength provided by concrete. The user may also use these forces to verify correctness of load input or as input to supplemental calculations of flexural and shear reinforcement for entire wall cross-sections.

Wall Shear Strength

For solid (without openings) walls designed according to the ACI code, the program optionally reports factored in-plane (V_{cx}) and out-of-plane (V_{cz}) shear strength provided by concrete in entire wall cross-sections above and below each horizontal grid line level. The shear strengths are also compared to the corresponding calculated shear forces V_{ux} and V_{uz} , respectively. The comparison may be used by the user to determine the adequacy of the wall thickness and whether additional shear reinforcement or minimum shear reinforcement is required in addition to the axial and flexural reinforcement calculated by the program.

2.4. Design Methods

2.4.1. Element Design Forces

The required areas of reinforcing steel for flexural and shear are computed based on assumptions conforming to the strength design method.

2.4.1.1. Plate Elements

For each ultimate load combination, the program obtains values for in-plane design forces by including the effects of in-plane shear forces as follows

Maximum in-plane design forces	Minimum in-plane design forces
$N_x = N_{xx} + N_{xy} $ $N_y = N_{yy} + N_{xy} $	$N_x = N_{xx} - N_{xy} $ $N_y = N_{yy} - N_{xy} $
$\text{Maximum } N_{ux} = \begin{cases} N_x & \text{if } N_y \geq 0 \\ N_{xx} + \left \frac{N_{xy}^2}{N_{yy}} \right & \text{if } N_y < 0 \end{cases}$	$\text{Minimum } N_{ux} = \begin{cases} N_x & \text{if } N_y \leq 0 \\ N_{xx} - \left \frac{N_{xy}^2}{N_{yy}} \right & \text{if } N_y > 0 \end{cases}$
$\text{Maximum } N_{uy} = \begin{cases} N_y & \text{if } N_x \geq 0 \\ N_{yy} + \left \frac{N_{xy}^2}{N_{xx}} \right & \text{if } N_x < 0 \end{cases}$	$\text{Minimum } N_{uy} = \begin{cases} N_y & \text{if } N_x \leq 0 \\ N_{yy} - \left \frac{N_{xy}^2}{N_{xx}} \right & \text{if } N_x > 0 \end{cases}$

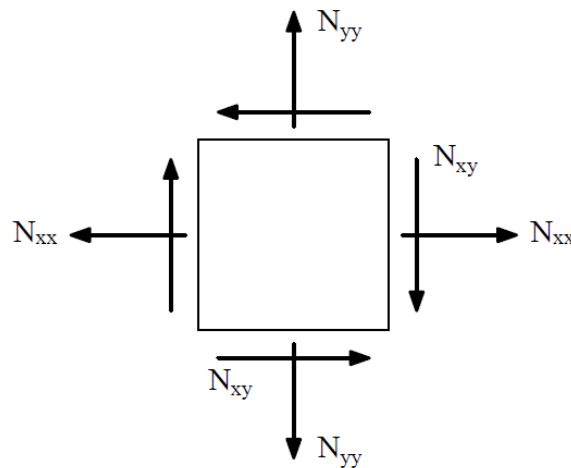

In the above equations, N_{xx} , N_{yy} and N_{xy} correspond to the element internal in-plane forces at the element center.

The program obtains the values for design bending moments by including the effects of the torsional moment as follows

Maximum design bending moments	Minimum design bending moments
$M_x = M_{xx} + M_{xy} $	$M_x = M_{xx} - M_{xy} $
$M_y = M_{yy} + M_{xy} $	$M_y = M_{yy} - M_{xy} $
$\text{Maximum } M_{ux} = \begin{cases} M_x & \text{if } M_y \geq 0 \\ M_{xx} + \frac{M_{xy}^2}{M_{yy}} & \text{if } M_y < 0 \end{cases}$	$\text{Minimum } M_{ux} = \begin{cases} M_x & \text{if } M_y \leq 0 \\ M_{xx} - \frac{M_{xy}^2}{M_{yy}} & \text{if } M_y > 0 \end{cases}$
$\text{Maximum } M_{uy} = \begin{cases} M_y & \text{if } M_x \geq 0 \\ M_{yy} + \frac{M_{xy}^2}{M_{xx}} & \text{if } M_x < 0 \end{cases}$	$\text{Minimum } M_{uy} = \begin{cases} M_y & \text{if } M_x \leq 0 \\ M_{yy} - \frac{M_{xy}^2}{M_{xx}} & \text{if } M_x > 0 \end{cases}$

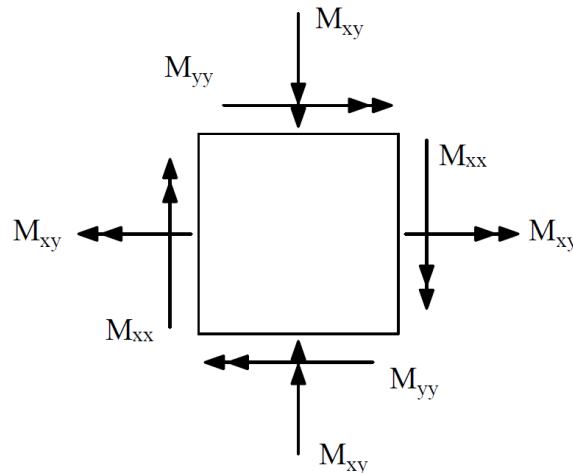

In the above equations, M_{xx} and M_{yy} correspond to the element internal bending moments at the element center, while M_{xy} corresponds to the element internal torsional moment at the element center.

2.4.1.2. Stiffener Elements

The stiffener element design forces P_u , V_{uy} , V_{uz} , T_u , M_{uy} , and M_{uz} are the envelope values of element internal forces N_x , V_y , V_z , T_x , M_y , and M_z for a given element.

The stiffener element internal forces N_x , V_y , V_z , T_x , M_y , and M_z are obtained directly from the element end forces F_x , F_y , F_z , M_x , M_y , and M_z (Figure 2.10) using the following relationship.

$$\begin{Bmatrix} N_x \\ V_y \\ V_z \\ T_x \\ M_y \\ M_z \end{Bmatrix}_{i, \text{ Internal Forces}} = \begin{Bmatrix} -F_x \\ F_y \\ F_z \\ M_x \\ M_y \\ -M_z \end{Bmatrix}_{i, \text{ End Forces}} \quad \text{at node i}$$

$$\begin{Bmatrix} N_x \\ V_y \\ V_z \\ T_x \\ M_y \\ M_z \end{Bmatrix}_{j, \text{ Internal Forces}} = \begin{Bmatrix} F_x \\ -F_y \\ -F_z \\ -M_x \\ -M_y \\ M_z \end{Bmatrix}_{j, \text{ End Forces}} \quad \text{at node j}$$

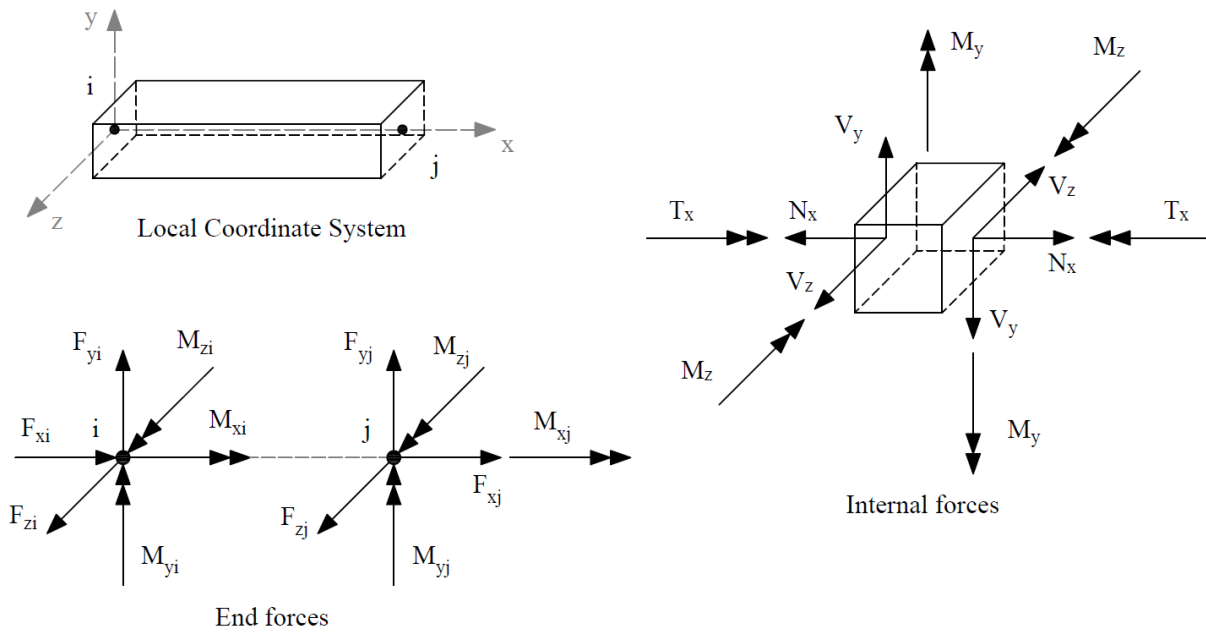

Figure 2.10 – Stiffener Internal Forces

2.4.2. Flexural Design

Flexural design is performed based on the code provisions of ACI 318 and CSA A23.3. Refer to [Section 2.7.1](#) for applicable Code Provisions and Equations.

The required area of steel is calculated by trial and error. The program will try to find the least amount of A_s , between the minimum and maximum values specified by the user, which satisfies the strength requirements of all ultimate load combinations. If a value for A_s cannot be found, the program reports design failure.

For plate elements, it is required to calculate the area of steel in the X and in the Y directions. In the X-direction, the area of steel A_{sx} should be enough to satisfy the strength requirements under the following sets of extreme design forces for each ultimate load combinations

- Maximum N_{ux} and Maximum M_{ux}
- Maximum N_{ux} and Minimum M_{ux}
- Minimum N_{ux} and Maximum M_{ux}
- Minimum N_{ux} and Minimum M_{ux}

In the Y-direction, the amount of steel A_{sy} should be enough to resist the following sets of extreme design forces for each ultimate load combinations

- Maximum N_{uy} and Maximum M_{uy}
- Maximum N_{uy} and Minimum M_{uy}
- Minimum N_{uy} and Maximum M_{uy}
- Minimum N_{uy} and Minimum M_{uy}

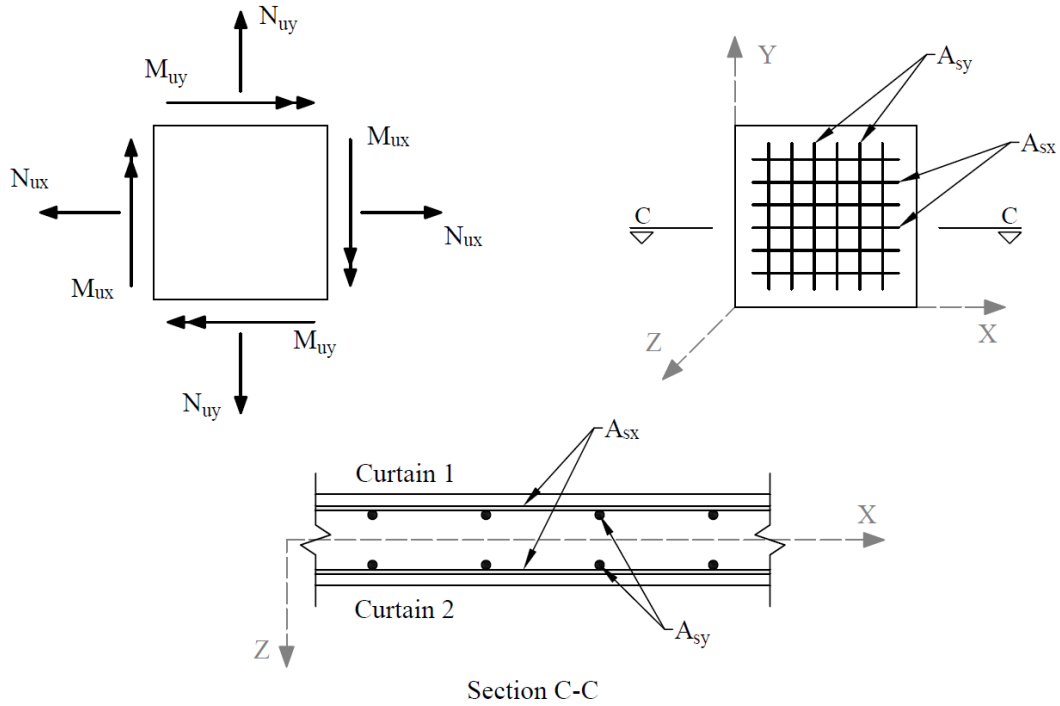

Figure 2.11 – Design Forces and Location of Bars

For stiffener element, the area of steel A_s is calculated such that the strength requirements at both end nodes are satisfied for all ultimate load combinations. The design of stiffener elements has two modes: biaxial and uniaxial modes.

The biaxial mode is applied when the flange width is equal to zero (Figure 2.12). In this case, the area of steel is calculated due to P_u , M_{uy} , and M_{uz} . When the flange width is specified, the neutral axis is forced to be along the local y axis. In this case, the area of steel is calculated due to P_u and M_{uy} .

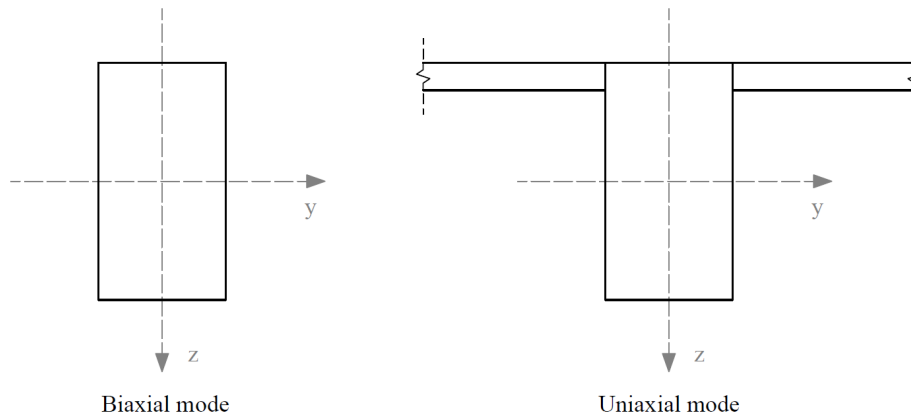

Figure 2.12 – Design Modes for Stiffener Elements

2.4.3. Shear design of stiffener elements

Shear design is performed based on the provisions of ACI 318 and the simplified method of CSA A23.3. Refer to [Section 2.7.3](#) for applicable Code Provisions and Equations.

For stiffener element, web reinforcement for shear and torsion A_w/s and longitudinal torsion reinforcement (A_l) are calculated such that the strength requirements at both end nodes are satisfied for all ultimate load combinations. The design of stiffener element has two modes: Biaxial and Uniaxial modes.

The biaxial mode is applied when the flange width is equal to zero ([Figure 2.12](#)). In this case, the amount of web reinforcement A_w/s is calculated in the Y-direction and in the Z-direction separately. The maximum values of $(A_w/s)_y$ and $(A_w/s)_z$ are reported. When the flange width is specified, the neutral axis is forced to be along the local y axis. In this case, the amount of web reinforcement (A_w/s) is calculated in the Z-direction only and the maximum value of $(A_w/s)_z$ is reported. The effective flange width considered for the design due to torsion is calculated according to clause 13.2.4 for ACI 318-02/05/08/11 and 9.2.4.4(a) for ACI 318-14, clause 13.1 for CSA A23.3-94, and clause 13.8.2.7 for CSA A23.3-04/14.

2.4.4. Calculating additional reinforcement due to shear & torsion

Procedure for calculating additional reinforcement due to shear and torsion based on CSA A23.3-14/04 standard.

Proportioning of longitudinal reinforcement for sections subjected to combined shear and torsion in flexural regions is based on the requirement that the resistance of the longitudinal reinforcement has to be greater or equal to the axial force that can be developed in this reinforcement. In non-prestressed sections ($V_p = 0$) these forces are equal to¹³:

- flexural tension side

$$F_{lt} = \underbrace{\frac{M_f}{d_v} + 0.5N_f}_{F_{lt,flexure}} + \cot \theta \underbrace{\sqrt{(V_f - 0.5V_s)^2 + \left(\frac{0.45p_h T_f}{2A_o}\right)^2}}_{F_{lt,shear}} = F_{lt,flexure} + F_{lt,shear}$$

- flexural compression side

$$F_{lc} = -\underbrace{\frac{M_f}{d_v} + 0.5N_f}_{F_{lc,flexure}} + \cot \theta \underbrace{\sqrt{(V_f - 0.5V_s)^2 + \left(\frac{0.45p_h T_f}{2A_o}\right)^2}}_{F_{lc,shear}} = F_{lc,flexure} + F_{lc,shear}$$

These forces can be decomposed¹⁴ into flexure and shear components. The flexure components, $F_{lt,flexure}$ and $F_{lc,flexure}$, account for the action of the bending moment, M_f , and the axial force, N_f , whereas the shear components, $F_{lt,shear}$ and $F_{lc,shear}$, account for the action of the shear force, V_f , and the torsional moment, T_f . The amounts of reinforcement needed to resist the flexure components are calculated separately in the flexure and axial design procedure. The total amount of the additional longitudinal reinforcement, A_l , needed to resist shear and torsion will be determined as follows

¹³ CSA A23.3-14, 11.3.9.2, 11.3.9.3, 11.3.10.6; CSA A23.3-04, 11.3.9.2, 11.3.9.3, 11.3.10.6

¹⁴ J.G. MacGregor, F.M. Bartlett, *Reinforced Concrete – Mechanics and Design*, First Canadian Edition, 2000, pp 294, Eq. 7-42

$$A_t = \frac{F_{lt, shear} + F_{lc, shear}}{\phi_s f_y} = \frac{2 \cot \theta \sqrt{(V_f - 0.5V_s)^2 + \left(\frac{0.45 p_h T_f}{2A_o}\right)^2}}{\phi_s f_y}$$

Please note that if only torsion acted ($V_f = 0$ and $V_s = 0$), then (assuming¹⁵ $\theta = 35^\circ$) A_t would reduce to

$$A_t = 2 \cot(35^\circ) \frac{\left(\frac{0.45 p_h T_f}{2A_o}\right)}{\phi_s f_y} = 1.285 \frac{p_h T_f}{2A_o \phi_s f_y}$$

which is comparable (and conservative) to the additional amount of longitudinal reinforcement due to torsion required in accordance with the previous edition of the CSA A23.3 standard¹⁶.

The additional longitudinal reinforcement, A_t , will only be calculated if a section is subjected to a significant shear or a significant torsion¹⁷, which is presumed to be the case¹⁸ if $V_f > V_c$ or $T_f > 0.25T_{cr}$. Otherwise, it is assumed that the flexural reinforcement is extended a distance of $d_v \cot \theta$ beyond the location needed by flexure alone and the additional reinforcement $A_t = 0$.

¹⁵ CSA A23.3-14, 11.3.6.3; CSA A23.3-04, 11.3.6.3

¹⁶ CSA A23.3-94, 11.3.9.5

¹⁷ CSA A23.3-14, 11.3.9.1; CSA A23.3-04, 11.3.9.1

¹⁸ CSA A23.3-14, 11.2.8.1, 11.2.9.1; CSA A23.3-04, 11.2.8.1, 11.2.9.1

In the biaxial case with two shear forces, V_{fy} and V_{fz} , the total additional reinforcement will be calculated as the sum of amounts needed in each direction i.e.

$$A_l = A_{ly} + A_{lz}$$

With

$$A_{lz} = \begin{cases} \frac{2 \cot \theta \sqrt{(V_{fz} - 0.5V_{sz})^2 + \left(\frac{0.45 p_h T_f}{2A_o}\right)^2}}{\phi_s f_y} & \text{if } V_{fz} > V_{cz} \text{ or } T_f > 0.25T_{cr} \\ 0 & \text{if } V_{fz} \leq V_{cz} \text{ and } T_f \leq 0.25T_{cr} \end{cases}$$

and

$$A_{ly} = \begin{cases} \frac{2 \cot \theta (V_{fy} - 0.5V_{sy})}{\phi_s f_y} & \text{if } V_{fy} > V_{cy} \\ 0 & \text{if } V_{fy} \leq V_{cy} \end{cases}$$

2.4.5. Wall Shear Strength

The program can calculate in-plane and out-of-plane concrete shear strength of the wall at horizontal cross-sections defined by each grid level. The calculated strength is then compared at each section to shear forces calculated from the applied loads. The option to calculate and check wall shear strength can be activated in the solver options only if the wall is solid (i.e. has no openings) and ACI code is selected. Refer to [Section 2.7.2](#) for applicable Code Provisions and Equations.

The ACI 318 code provides two sets of provisions to calculate wall shear strength. Detailed provisions are available in the program only for walls with constant thickness and concrete material. These walls are referred to by the program as uniform walls. For non-uniform walls, where wall thickness or concrete material is not constant, only simplified provisions are available. The user can invoke either detailed or simplified provisions for uniform walls based on their engineering judgment.

If wall shear strength is exceeded in the out-of-plane direction then the increase of concrete strength or wall thickness should be considered, or additional transverse reinforcement in the form of ties, stirrups, or headed bars should be provided. The amount of transverse reinforcement has to be calculated by the user separately.

To account for in-plane shear, the program calculates horizontal and vertical reinforcement requirement using formulas described in [Element Design Forces Section](#). This reinforcement is calculated for each element using different approach than stipulated by Shear Provisions for Walls in ACI code¹⁹. When the concrete in-plane shear strength is exceeded by calculated shear forces, the increase of concrete strength or wall thickness should be considered. Alternatively, additional horizontal and vertical shear reinforcement should be provided as required by ACI provisions for walls²⁰. This would be conservative since the contribution of in-plane shear is partially considered in axial and flexural reinforcement design as described in [Element Design Forces Section](#).

¹⁹ ACI 318-11, 11.9; ACI 318-08, 11.9, ACI 318-05, 11.10, ACI 318-02, 11.10

²⁰ ACI 318-02, 14.3; ACI 318-05, 14.3; ACI 318-08, 14.3; ACI 318-11, 14.3; ACI 318-14, 11.6

2.5. Detailing Provisions

2.5.1. Reinforcement Under Concentrated Loads

Loads applied to a wall model to represent a framing member reaction or a support for Mechanical, Electrical and Plumbing (MEP) equipment or utilities are typically concentrated (Point) loads. Depending on the bearing area of the support the point load may be distributed or spread to input as a line load thus reducing the concentration effect. In these situations, the user may consider additional reinforcing details to facilitate the load path and load distribution near the support installation and mitigate against localized damage to the concrete wall. This will also help in transmitting the load physically to the wall as intended by the user in the analytical model.

2.5.2. Reinforcement for Reentrant Corners

A re-entrant corner is frequently encountered in structural wall systems with openings for windows, doors, and other penetrations. The spWall graphical output (contours) may be used to examine any stress concentrations or distortion that may occur as the load path is subject to an abrupt change in section geometry and possible reduction in stiffness. The program computes the required reinforcement in the horizontal and vertical directions for elements in the reentrant corner zone similar to all other elements. However, depending on loading and support conditions, such a corner may be subject to cracking and may benefit from some additional reinforcement typically in a diagonal direction to control cracking. Regardless of minimum code requirement presence, such considerations should be based on the judgment of the design professional to achieve the desired serviceability of the completed wall system.

2.5.3. Wall Anchorage and Dowel Design

Additional reinforcement may be required where anchorage to concrete walls may be subject to pullout, tension side bursting, or shear side bursting. Such reinforcement must be determined as part of the anchorage calculations and be designed and detailed to satisfy the assumptions made by the user input regarding the load path and distribution. This is essential, like concentrated loads

discussed earlier, in order to ensure proper transmission of load to the intended structural wall. A typical example is encountered where a horizontal floor or roof diaphragm is attached to a structural wall to deliver lateral loads and simultaneously provide the wall with lateral out-of-plane restraint.

2.5.4. Reinforcement Confinement in Walls with High Compression

Structural walls are frequently designed with out of plane loads and two curtains of reinforcement. spWall has an option for design of walls with two curtains of reinforcement as well as one curtain of reinforcement to accommodate various needed wall thicknesses.

For each plate element, the required areas of reinforcement A_{sx} and A_{sy} are computed based on the average moments per element and are output along with design forces and governing ultimate load combination. In both horizontal and vertical directions, the reported reinforcement is the total required area of steel per unit length. Half of the reported value applies to each curtain in models with two curtain layout.

If the area of vertical reinforcement required for a plate element is greater than one percent (1%) of the gross area of the concrete section (0.5% for CSA A23.3), the program indicates that ties are required for bars in compression. If the program reports that ties are required for a single curtain design, switching to two curtain design should be considered by the user. The proper consideration of this condition as provided by spWall is important to ensure the successful performance of compression reinforcement in the wall section.

The general considerations for design of wall elements in spWall are as follow:

- spWall calculates the required reinforcement only for the ultimate load combinations.
- For walls with two curtains of reinforcement, spWall considers contribution of both layers in calculation of required reinforcement.
- In cases where the load is not reversible from wind or seismic (i.e. only one layer of steel is subjected to maximum stress like in a retaining wall) the design may be conservative and the user can use a single layer option to optimize the design.

- The plate design criteria section of the inputs provides options for minimum and maximum reinforcement ratios (A_s/A_g) and location of reinforcement centroid with respect to the face of the wall for each curtain.
- One curtain is not permitted for wall thicker than 10 inches by default unless the box is checked to allow this condition in cases where the user deems suitable.
- spWall permits the user to override the default code minimum reinforcement ratios for investigation of as built wall by invoking the check box for “Allow minimum below code”.
- spWall calculate the required reinforcement for all ultimate load combinations and reports the greatest value and the corresponding load combination.
- In instances where the required area of vertical reinforcement for a plate element is greater than one percent (1%) (0.5% for CSA A23.3), spWall will examine the location of the neutral axis and indicates that ties are required for bars in compression by placing a star in the Tie column.
- The load combination which calls for “Ties required” flag is not necessarily the same load combination from which the greatest required reinforcement is reported.

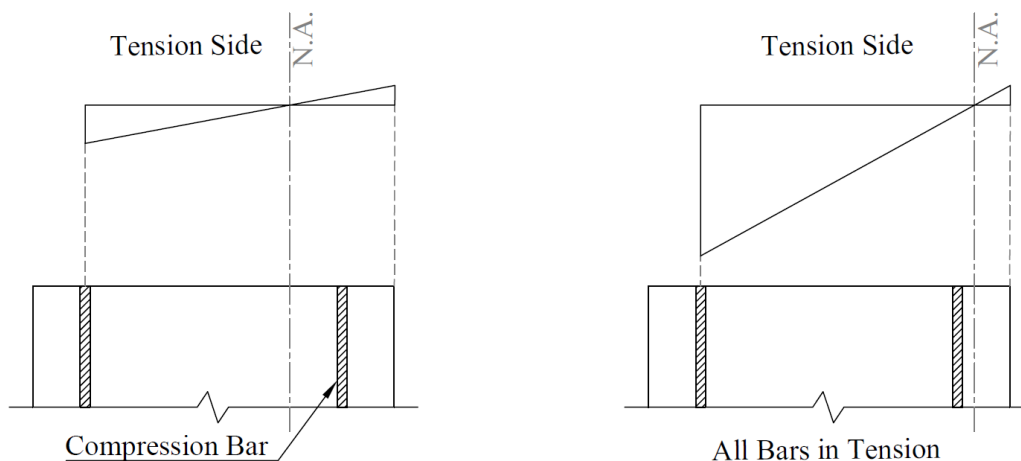

2.6. Special Topics

2.6.1. Cracking Coefficient and Effective Flexural Stiffness of Concrete Walls

The cracked moment of inertia for structural walls including precast and tilt-up wall panels can be calculated using different provisions permissible in codes and standards. This design professional has several choices to select from when making a decision as to which methods to use and that depends partially on the wall application and its required behavior under service conditions. This [Technical Article](#) discusses and compares the commonly used provisions in ACI 318-14 to calculate the cracked moment of inertia. It also reveals the considerable variation that exists for this design parameter as well as its impact on the strength and serviceability of the structural member under consideration.

2.6.2. Shear Wall Seismic Design Considerations

Shear wall reinforcement detailing to meet seismic design provisions is required by codes and standards. It is also dependent on seismic design categories and other factors. The reinforcement computed by spWall needs to be distributed and detailed further by the design professional to ensure that seismic design and detailing required by the relevant code are implemented. Such requirements are explained further in various references and code documents. Seismic Detailing of Concrete Buildings from the Portland Cement Association (PCA) contains a comprehensive summary of the seismic detailing requirements in ACI 318.

2.6.3. Retaining Wall Design Considerations

Reinforced concrete cantilever retaining walls consist of a relatively thin stem and a base slab. The stem may have constant thickness along the length or may be tapered based on economic and construction criteria. Cantilever retaining walls whether precast in a factory or formed on site can be analyzed and designed using the engineering software programs spWall and spMats. This [Design Example](#) and [Case Study](#) explore the traditional hand solution for a cantilevered retaining wall and provides a comparable solution with the finite element method (FEM) using spWall. Using spWall extends the flexibility of the end user to model nonstandard condition of support and loading for earth retention wall systems. Similarly, spWall effectively models the behavior of highway sound walls, soil nail walls, and tie-back anchored retaining walls with focus on understanding the support reactions and wall out-of-plan displacements with active or passive restraints.

2.6.4. Tank Wall Design Considerations

Reinforced concrete tanks are used widely to collect and contain liquids from wastewater stations, process facilities, agricultural and environmental plants. This [Case Study](#) focuses on the design considerations for rectangular concrete tank walls and base slab with emphasis on the variation of the loading cases and load combination required to adequately address all stage of construction and operations.

Many design professionals depend on simplified conservative assumptions for analysis of tank walls or rely on design coefficients such as the tables provided in the “Rectangular Concrete Tanks” Design handbook by the Portland Cement Association (PCA). In spWall tank wall design conditions and loading scenarios can extend the limits of hand solutions and provide the end user with control over support locations, load distribution, placement of openings and much more flexibility to examine the behavior of the complete tank structure. This is particularly relevant in the design for durability and liquid tightness where specialized load factors and load combinations are necessary to meet stricter functionality or serviceability conditions such as that of ACI-349 or ACI-350. More information about this topic can be found in this [Article](#).

2.6.5. Deep Beam & Transfer Girder Design Considerations

The spWall program is typically used for the analysis and design of structural reinforced concrete walls. Additionally, the program can be used to analyze and design deep beams, transfer girders, coupling beams, corbels, pile caps, and other non-standard concrete elements with geometric discontinuity. The Strut-and-Tie Model (STM) is a tool for the analysis, design, and detailing of reinforced concrete members. It is essentially a truss analogy, based on the fact that concrete is strong in compression, and that steel is strong in tension. Truss members that are in compression are made up of concrete, while truss members that are in tension consist of steel reinforcement. STM provides a design approach, applicable to an array of design problems that do not have an explicit design solution in the body of structural codes. This method requires the design professional to consciously select a realistic load path within the structural member in the form of an idealized truss. Rational detailing of the truss elements and compliance with equilibrium assures the safe transfer of loads to the supports or to other regions designed by conventional procedures. While solutions provided with this powerful analysis and design tool are not unique, they represent a conservative lower bound approach.

Deep beams such as transfer girders can be analyzed and designed by any procedure satisfying equilibrium and geometric compatibility. Two established methods are widely used. The Strut-and-Tie Model or Method (STM). This method gives the engineer considerable control over modeling choices and ways to assert engineering judgement. Finite Element Method (FEM) is another method for analyzing reinforced concrete deep beams, particularly useful for irregular beams and walls with variable thicknesses, openings, and other features that limit the use of STM or significantly complicate the STM truss and calculations. Many reputable commercial FEM analysis software packages are available on the market today such as spWall. Using FEM requires critical understanding of the relationship between the actual behavior of the structure and the numerical simulation since this method is an approximate numerical method. FEM is based on several assumptions and the engineer has a great deal of decisions to make while setting up the model and applying loads and boundary conditions. The results obtained from FEM models should be verified to confirm their suitability for design and detailing of concrete structures. This [Design Example](#) discusses in detail the analysis and design of deep beam (transfer girder) using STM and FEM.

spWall program offers [Deep Beam Templates](#) to enable the user to select from a set of pre-defined templates and edit them for quick model generation.

2.6.6. Shear Wall Lateral Displacement and Stability in High-Rise Buildings

Lateral displacement of shear walls in high-rise buildings and structures is a critical design parameter with a direct impact on the functionality and serviceability of a building and its occupant comfort. In tall structures lateral displacements also must be controlled to preserve content and operability within permissible tolerances. This [Case Study](#) experiments with the displacement computation and magnitude investigated in spWall using different [Cracking Coefficient Equations](#). Study indicates that using reduced stiffness in critical region (heel of shear wall) has significant effect on the lateral displacement of shear walls and need to be considered. The reduced stiffness can be calculated using different ACI 318 provisions or using more detailed analysis.

2.6.7. Alternative Method for Out-of-Plane Slender Wall Analysis

Limitations

Concrete walls analyzed using simplified methods in structural concrete standards must meet and comply with a number of conditions for such methods to be suitable. This [Technical Article](#) is intended to assist design professional with such conditions in wall systems and reviews options for concrete walls spanning a number of floors with and without openings. Special attention is paid to the proper calculation of moment magnification due to second order effects and exacting the location of maximum design moments after magnification.

2.6.8. Multi-Story Tilt-up Wall Considerations

Multi-story structural tilt-up walls frequently used in low-rise and mid-rise construction present a number of additional considerations beyond what is commonly covered in codes and standards for simply supported single span structural walls. In this [Design Example](#) and the [Technical Article](#), the limits of applicability of simplified alternative analysis method is explored along with additional considerations for multi-span continuous wall. In continuous wall models, the

maximum positive moments don't necessarily occur at midspan. Also, second order effects lead to moment magnification that may further shift the location of the maximum design moments in each span. Many other issues arise with panels with cantilevered spans, variable thickness and width, irregular openings, non-standard boundary conditions, high compressive loads, non-standard concentrated load, and intermediate support at ground floor slab locations.

2.6.9. Lifting, Shoring, and Bracing of Wall Panels

Wall panels in earth retention structures, precast and tilt-up buildings, and deep foundations regularly require wall analysis during lifting, shoring, and bracing. Such analyses may be for short term erection and construction load conditions or long-term service conditions with requiring stabilization. spWall can be used to model and analyze a variety of these construction scenarios by using a comprehensive set of boundary conditions and nodal restraints to investigate the wall behavior, strengths, and required reinforcing. Contact [StructurePoint support](#) to discuss specialty examples and case studies from our archives including specialty applications of tiebacks, walers, and rakers/struts installed as part of a shoring system to resist earth and water pressures.

2.6.10. Insulating Concrete Forms (ICF) Walls

Insulating concrete form (ICF) is a concrete formwork system made of rigid thermal insulation that stays in place as a permanent interior and exterior substrate for walls, floors, and roofs. This [Case Study](#) focuses on the design of ICF walls using the engineering software program spWall. The ICF wall under study is in a typical four-story residential building with prestressed precast hollow core concrete plank floor with a 2-inch concrete cast in place topping. A review of the out of plane wind load displacement and support reactions along with the required reinforcement is included.

2.7. Code Provisions and Equations

This section presents code provisions and equations pertaining to the structural code cycle as used by spWall and outlines any differences that exist between code cycles.

2.7.1. Flexure Design

For each of the design codes available in spWall, a summary of flexural design requirements is given below:

2.7.1.1. ACI 318-14

$$\phi = \begin{cases} 0.90 & \text{if } \varepsilon_t \geq 0.005 \\ 0.65 + \frac{0.25(\varepsilon_t - f_y / E_s)}{0.005 - f_y / E_s} & \text{if } f_y / E_y < \varepsilon_t < 0.005 \\ 0.65 & \text{if } \varepsilon_t \leq f_y / E_y \end{cases} \quad (21.2.2)$$

- Maximum usable $f_y = 80.0$ ksi (20.2.2.4)
- An elastic perfectly plastic stress-strain distribution is assumed for the reinforcing steel (20.2.2.1)
- Strains in concrete and steel are assumed directly proportional to the distance from neutral axis (22.1.2, 22.2.1.2)
- Maximum concrete strain = 0.003 (22.2.2.1)
- Tensile strength of concrete is neglected (22.2.2.2)
- Equivalent rectangular stress distribution is used to represent the relationship between concrete compression stress and concrete strain (22.2.2.4)
- $f_c = 0.85 f'_c$ (22.2.2.4.1)

- $$\beta_1 = \begin{cases} 0.85 & \text{if } f'_c \leq 4 \text{ ksi} \\ 0.85 - 0.05(f'_c - 4 \text{ ksi}) & \text{if } 4 < f'_c < 8 \text{ ksi} \\ 0.65 & \text{if } f'_c \geq 8 \text{ ksi} \end{cases} \quad (22.2.2.4.3)$$
- Tension control starts at $\varepsilon_t = 0.005$ (21.2.2)
 - Compression control starts at $\varepsilon_t = \varepsilon_y = f_y / E_s$ (21.2.2, 21.2.2.1, 21.2.2.2)
- Maximum axial strength $\phi P_{n,\max} = 0.80\phi(0.85f'_c(A_g - A_{st}) + f_y A_{st})$ (22.4.2.1, 22.4.2.2)
- Minimum ratio of vertical reinforcement $\rho = 0.0012$ (11.6.1)
- Minimum ratio of horizontal reinforcement $\rho = 0.0020$ (11.6.1)
- Minimum ratio of reinforcement (both directions) in precast walls $\rho = 0.001$ (11.6.1, 11.7.2.2, 11.7.3.2)
- Ties are required for vertical reinforcement in compression if $\rho > 0.01$ (11.7.4.1)
- Maximum wall thickness with one curtain of reinforcement = 10 in. (except basement walls) (11.7.2.3)
- $\Delta_s \leq l_c / 150$ (11.8.1.1(e), 11.8.4.1, 11.8.4.2, 11.8.4.3, 11.8.4.4)

2.7.1.2. ACI 318-11/08

$$\bullet \phi = \begin{cases} 0.90 & \text{if } \varepsilon_t \geq 0.005 \\ 0.65 + \frac{0.25(\varepsilon_t - f_y / E_s)}{0.005 - f_y / E_s} & \text{if } f_y / E_y < \varepsilon_t < 0.005 \\ 0.65 & \text{if } \varepsilon_t \leq f_y / E_y \end{cases} \quad (9.3.2)$$

$$\bullet \text{ Maximum usable } f_y = 80.0 \text{ ksi} \quad (9.4)$$

$$\bullet \text{ An elastic perfectly plastic stress-strain distribution is assumed for the reinforcing steel} \quad (10.2.4)$$

$$\bullet \text{ Strains in concrete and steel are assumed directly proportional to the distance from neutral axis} \quad (10.2.2)$$

$$\bullet \text{ Maximum concrete strain} = 0.003 \quad (10.2.3)$$

$$\bullet \text{ Tensile strength of concrete is neglected} \quad (10.2.5)$$

$$\bullet \text{ Equivalent rectangular stress distribution is used to represent the relationship between concrete compression stress and concrete strain} \quad (10.2.7)$$

$$\bullet f_c = 0.85 f'_c \quad (10.2.7.1)$$

$$\bullet \beta_1 = \begin{cases} 0.85 & \text{if } f'_c \leq 4 \text{ ksi} \\ 0.85 - 0.05(f'_c - 4 \text{ ksi}) & \text{if } 4 < f'_c < 8 \text{ ksi} \\ 0.65 & \text{if } f'_c \geq 8 \text{ ksi} \end{cases} \quad (10.2.7.3)$$

$$\bullet \text{ Tension control starts at } \varepsilon_t = 0.005 \quad (10.3.4)$$

$$\text{Compression control starts at } \varepsilon_t = \varepsilon_y = f_y / E_s \quad (10.3.3)$$

$$\bullet \text{ Maximum axial strength } \phi P_{n,\max} = 0.80\phi \left(0.85 f'_c (A_g - A_{st}) + f_y A_{st} \right) \quad (10.3.6.2)$$

$$\bullet \text{ Minimum ratio of vertical reinforcement } \rho = 0.0012 \quad (14.3.2)$$

- Minimum ratio of horizontal reinforcement $\rho = 0.0020$ (14.3.3)
- Minimum ratio of reinforcement (both directions) in precast walls $\rho = 0.001$ (16.4.2)
- Maximum wall thickness with one curtain of reinforcement = 10 in. (except basement walls) (14.3.4)
- Ties are required for vertical reinforcement in compression if $\rho > 0.01$ (14.3.6)
- $\Delta_s \leq l_c / 150$ (14.8.4)

2.7.1.3. ACI 318-05

$$\bullet \phi = \begin{cases} 0.90 & \text{if } \varepsilon_t \geq 0.005 \\ 0.65 + \frac{0.25(\varepsilon_t - f_y / E_s)}{0.005 - f_y / E_s} & \text{if } f_y / E_y < \varepsilon_t < 0.005 \\ 0.65 & \text{if } \varepsilon_t \leq f_y / E_y \end{cases} \quad (9.3.2)$$

$$\bullet \text{ Maximum usable } f_y = 80.0 \text{ ksi} \quad (9.4)$$

$$\bullet \text{ An elastic perfectly plastic stress-strain distribution is assumed for the reinforcing steel} \quad (10.2.4)$$

$$\bullet \text{ Strains in concrete and steel are assumed directly proportional to the distance from neutral axis} \quad (10.2.2)$$

$$\bullet \text{ Maximum concrete strain} = 0.003 \quad (10.2.3)$$

$$\bullet \text{ Tensile strength of concrete is neglected} \quad (10.2.5)$$

$$\bullet \text{ Equivalent rectangular stress distribution is used to represent the relationship between concrete compression stress and concrete strain} \quad (10.2.7)$$

$$\bullet f_c = 0.85 f'_c \quad (10.2.7.1)$$

$$\bullet \beta_1 = \begin{cases} 0.85 & \text{if } f'_c \leq 4 \text{ ksi} \\ 0.85 - 0.05(f'_c - 4 \text{ ksi}) & \text{if } 4 < f'_c < 8 \text{ ksi} \\ 0.65 & \text{if } f'_c \geq 8 \text{ ksi} \end{cases} \quad (10.2.7.3)$$

$$\bullet \text{ Tension control starts at } \varepsilon_t = 0.005 \quad (10.3.4)$$

$$\text{Compression control starts at } \varepsilon_t = \varepsilon_y = f_y / E_s \quad (10.3.3)$$

$$\bullet \text{ Maximum axial strength } \phi P_{n,\max} = 0.80\phi \left(0.85 f'_c (A_g - A_{st}) + f_y A_{st} \right) \quad (10.3.6.2)$$

$$\bullet \text{ Minimum ratio of vertical reinforcement } \rho = 0.0012 \quad (14.3.2)$$

- Minimum ratio of horizontal reinforcement $\rho = 0.0020$ (14.3.3)
- Minimum ratio of reinforcement (both directions) in precast walls $\rho = 0.001$ (16.4.2)
- Ties are required for vertical reinforcement in compression if $\rho > 0.01$ (14.3.6)
- Maximum wall thickness with one curtain of reinforcement = 10 in. (except basement walls) (14.3.4)
- $\Delta_s \leq l_c / 150$ (14.8.4)

2.7.1.4. ACI 318-02

$$\bullet \phi = \begin{cases} 0.90 & \text{if } \varepsilon_t \geq 0.005 \\ 0.65 + \frac{0.25(\varepsilon_t - f_y / E_s)}{0.005 - f_y / E_s} & \text{if } f_y / E_y < \varepsilon_t < 0.005 \\ 0.65 & \text{if } \varepsilon_t \leq f_y / E_y \end{cases} \quad (9.3.2)$$

$$\bullet \text{ Maximum usable } f_y = 80.0 \text{ ksi} \quad (9.4)$$

$$\bullet \text{ An elastic perfectly plastic stress-strain distribution is assumed for the reinforcing steel} \quad (10.2.4)$$

$$\bullet \text{ Strains in concrete and steel are assumed directly proportional to the distance from neutral axis} \quad (10.2.2)$$

$$\bullet \text{ Maximum concrete strain} = 0.003 \quad (10.2.3)$$

$$\bullet \text{ Tensile strength of concrete is neglected} \quad (10.2.5)$$

$$\bullet \text{ Equivalent rectangular stress distribution is used to represent the relationship between concrete compression stress and concrete strain} \quad (10.2.7)$$

$$\bullet f_c = 0.85 f'_c \quad (10.2.7.1)$$

$$\bullet \beta_1 = \begin{cases} 0.85 & \text{if } f'_c \leq 4 \text{ ksi} \\ 0.85 - 0.05(f'_c - 4 \text{ ksi}) & \text{if } 4 < f'_c < 8 \text{ ksi} \\ 0.65 & \text{if } f'_c \geq 8 \text{ ksi} \end{cases} \quad (10.2.7.3)$$

$$\bullet \text{ Tension control starts at } \varepsilon_t = 0.005 \quad (10.3.4)$$

$$\text{Compression control starts at } \varepsilon_t = \varepsilon_y = f_y / E_s \quad (10.3.3)$$

$$\bullet \text{ Maximum axial strength } \phi P_{n,\max} = 0.80\phi \left(0.85 f'_c (A_g - A_{st}) + f_y A_{st} \right) \quad (10.3.6.2)$$

$$\bullet \text{ Minimum ratio of vertical reinforcement } \rho = 0.0012 \quad (14.3.2)$$

- Minimum ratio of horizontal reinforcement $\rho = 0.0020$ (14.3.3)
- Minimum ratio of reinforcement (both directions) in precast walls $\rho = 0.001$ (16.4.2)
- Ties are required for vertical reinforcement in compression if $\rho > 0.01$ (14.3.6)
- Maximum wall thickness with one curtain of reinforcement = 10 in. (except basement walls) (14.3.4)
- $\Delta_s \leq l_c / 150$ (14.8.4)

2.7.1.5. CSA A23.3-14

- $\phi_c = 0.65$ (8.4.2)
- $\phi_c = 0.70$ for precast concrete (16.1.3)
- $\phi_s = 0.85$ (8.4.3)
- Maximum usable steel f_y in tension = 500 MPa (8.5.1)
- Maximum usable steel f_y in compression = 400 MPa (8.5.2)
- An elastic perfectly plastic stress-strain distribution is assumed for the reinforcing steel (8.5.3.2)
- Maximum usable concrete $f'_c = 80$ MPa (8.6.1.1)
- Strains in concrete and steel are assumed directly proportional to the distance from neutral axis (10.1.2)
- Maximum concrete strain = 0.0035 (10.1.3)
- Tensile strength of concrete is neglected (10.1.5)
- Equivalent rectangular stress distribution is used to represent the relationship between concrete compression stress and concrete strain (10.1.7)
 - $f_c = \alpha_1 \phi_c f'_c$
 - $\alpha_1 = 0.85 - 0.0015 f'_c \geq 0.67$
 - $\beta_1 = 0.97 - 0.0025 f'_c \geq 0.67$
- Maximum factored axial load resistance $(P_r) = (0.2 + 0.002h) P_{ro} \leq 0.80 P_{ro}$ (10.10.4)
 - Reduction factor due to “h” is applied to wall elements.

- Reduction factor due to “h” is not applied to stiffener elements.
- If minimum stiffener dimension is less than 300 mm, judgment shall be used in the determination of the maximum factored axial load resistance.
- Minimum ratio of vertical reinforcement $\rho = 0.0015$ (14.1.8.5)
- Minimum ratio of horizontal reinforcement $\rho = 0.0020$ (14.1.8.6)
- Minimum ratio of reinforcement (both directions) in non-prestressed precast walls $\rho = 0.001$ (16.4.3.3)
- Ties are required for vertical reinforcement in compression if $\rho > 0.005$ (14.1.8.7)
- Maximum wall thickness with one curtain of reinforcement = 210 mm (except basement and retaining walls) (14.1.8.3)
- $\Delta_s \leq l / 100$ (23.3.2)

2.7.1.6. CSA A23.3-04

- $\phi_c = 0.65$ (8.4.2)
- $\phi_c = 0.70$ for precast concrete (16.1.3)
- $\phi_s = 0.85$ (8.4.3)
- Maximum usable steel f_y in tension = 500 MPa (8.5.1)
- Maximum usable steel f_y in compression = 400 MPa (8.5.2)
- An elastic perfectly plastic stress-strain distribution is assumed for the reinforcing steel (8.5.3.2)
- Maximum usable concrete $f'_c = 80$ MPa (8.6.1.1)
- Strains in concrete and steel are assumed directly proportional to the distance from neutral axis (10.1.2)
- Maximum concrete strain = 0.0035 (10.1.3)
- Tensile strength of concrete is neglected (10.1.5)
- Equivalent rectangular stress distribution is used to represent the relationship between concrete compression stress and concrete strain (10.1.7)
 - $f_c = \alpha_1 \phi_c f'_c$
 - $\alpha_1 = 0.85 - 0.0015 f'_c \geq 0.67$
 - $\beta_1 = 0.97 - 0.0025 f'_c \geq 0.67$
- Maximum factored axial load resistance (P_r) = $0.80 P_{ro}$ (10.10.4)
- Minimum ratio of vertical reinforcement $\rho = 0.0015$ (14.1.8.5)

- Minimum ratio of horizontal reinforcement $\rho = 0.0020$ (14.1.8.6)
- Minimum ratio of reinforcement (both directions) in non-prestressed precast walls
 $\rho = 0.001$ (16.4.3.3)
- Ties are required for vertical reinforcement in compression if $\rho > 0.005$ (14.1.8.7)
- Maximum wall thickness with one curtain of reinforcement = 210 mm (except basement and retaining walls) (14.1.8.3)
- $\Delta_s \leq l / 100$ (23.3.2)

2.7.1.7. CSA A23.3-94

- $\phi_c = 0.60$ (8.4.2)
- $\phi_s = 0.85$ (8.4.3)
- Maximum usable steel f_y in tension = 500 MPa (8.5.1)
- Maximum usable steel f_y in compression = 400 MPa (8.5.2)
- An elastic perfectly plastic stress-strain distribution is assumed for the reinforcing steel (8.5.3.2)
- Maximum usable concrete $f'_c = 80$ MPa (8.6.1.1)
- Strains in concrete and steel are assumed directly proportional to the distance from neutral axis (10.1.2)
- Maximum concrete strain = 0.0035 (10.1.3)
- Tensile strength of concrete is neglected (10.1.5)
- Equivalent rectangular stress distribution is used to represent the relationship between concrete compression stress and concrete strain (10.1.7)
 - $f_c = \alpha_1 \phi_c f'_c$
 - $\alpha_1 = 0.85 - 0.0015 f'_c \geq 0.67$
 - $\beta_1 = 0.97 - 0.0025 f'_c \geq 0.67$
- Maximum factored axial load resistance (P_r) = 0.80 P_{ro} (10.10.4)
- Minimum ratio of vertical reinforcement $\rho = 0.0015$ (14.3.2)
- Minimum ratio of horizontal reinforcement $\rho = 0.0020$ (14.3.3)

- Minimum ratio of reinforcement (both directions) in precast walls $\rho = 0.001$ (16.4.3.4)
- Ties are required for vertical reinforcement in compression if $\rho > 0.01$ (14.3.6)
- Maximum wall thickness with one curtain of reinforcement = 250 mm (14.3.4)
- $\Delta_s \leq l / 100$ (23.4.2)

2.7.2. Wall Shear Strength Provided by Concrete

For each of the design codes available in spWall, a summary of shear strength requirements is given below:

2.7.2.1. Wall Shear Strength Provided by Concrete – In-Plane

Simplified Equations

In-plane shear strength provided by section ‘j’ in a uniform or non-uniform concrete wall is calculated using the following equations²¹:

$$V_{cx_j} = \begin{cases} 2 \sum_{i=1}^n \lambda \sqrt{f'_{c_{j_i}}} h_{z_{j_i}} d_{x_j} & \text{if } N_{wy_j} > 0, \text{ (compression)} \\ 2 \sum_{i=1}^n \lambda \sqrt{f'_{c_{j_i}}} h_{z_{j_i}} d_{x_j} & \text{if } N_{wy_j} = 0 \\ 2 \left(1 + \frac{N_{wy_j}}{500 A_{g_j}} \right) \sum_{i=1}^n \lambda \sqrt{f'_{c_{j_i}}} h_{z_{j_i}} d_{x_j} & \text{if } (-500 A_{g_j}) < N_{wy_j} < 0, \text{ (tension)} \\ 0 & \text{if } N_{wy_j} < -500 A_{g_j} \end{cases}$$

Where:

j = index of the horizontal cross-sections either above or below a horizontal grid line.

i = summation index of wall elements along the section ‘j’.

n = number of elements along the section ‘j’.

N_{wy_j} = global factored axial force equal to the sum of vertical Y-axis components of all forces above the section ‘j’ including applied loads and reactions, positive if compressive and negative if tensile.

²¹ ACI 318-14, 11.5.4.5, 11.5.4.6; ACI 318-11, 11.9.5, 11.9.4, 11.2.2.3; ACI 318-08, 11.9.5, 11.9.4, 11.2.2.3; ACI 318-05, 11.10.5, 11.10.4, 11.3.2.3; ACI 318-02, 11.10.5, 11.10.4, 11.3.2.3

λ = factor to account for low-density concrete²².

l_{w_j} = overall length of the wall along the section 'j'.

d_{x_j} = $0.8l_{w_j}$

h_{z_j} = thickness in Z-direction of the wall element 'i' along the section 'j'.

$\sqrt{f'_{c_j}}$ = square root of specified compressive strength of concrete for the wall element 'i' along the section 'j'. The value of $\sqrt{f'_{c_j}}$ shall not exceed 100 pi.

A_{g_j} = gross area of concrete section 'j'.

Detailed Equations

In-plane shear strength provided by section 'j' in a uniform concrete wall can be based on the following detailed equations²³:

$$V_{cx_j} = \min \left[\left(0.6\lambda\sqrt{f'_{c_j}} + \frac{l_{w_j} \left(1.25\lambda\sqrt{f'_{c_j}} + 0.2\frac{N_{uy_j}}{l_{w_j}h_{z_j}} \right)}{\frac{M_{uz_j}}{V_{ux_j}} - \frac{l_{w_j}}{2}} \right) h_{z_j} d_{x_j} \right. \\ \left. 3.3\lambda\sqrt{f'_{c_j}} h_{z_j} d_{x_j} + \frac{N_{uy_j} d_{x_j}}{4l_{w_j}} \right]$$

²² ACI 318-14, 19.2.4.1, 19.2.4.2, 19.2.4.3, 26.4.2.1(a)(10); ACI 318-11, 8.6.1; ACI 318-08, 8.6.1; ACI 318-05, 11.2.1.2; ACI 318-02, 11.2.1.2

²³ ACI 318-14, 11.5.4.6; ACI 318-11, 11.9.6; ACI 318-08, 11.9.6; ACI 318-05, 11.10.6; ACI 318-02, 11.10.6

$$\text{If } \frac{M_{uz_j}}{V_{ux_j}} - \frac{l_{w_j}}{2} \leq 0 \text{ then } V_{cx_j} = 3.3\lambda \sqrt{f'_{c_j}} h_{z_j} d_{x_j} + \frac{N_{wy_j} d_{x_j}}{4l_{w_j}}$$

Where:

V_{ux_j} = global factored in-plane shear force equal to the absolute value of sum of horizontal X-axis components of all forces above the section 'j' including applied loads and reactions. V_{ux_j} cannot exceed $10\phi \sqrt{f'_{c_j}} h_{z_j} d_{x_j}$ for ACI 318-14/11/08 codes²⁴ and $10\phi\lambda \sqrt{f'_{c_j}} h_{z_j} d_{x_j}$ for ACI 318-05/02 codes²⁵.

M_{uz_j} = global factored in-plane bending moment equal to the sum of moments about Z-axis with respect to the centroid of the critical section of all forces above the section 'j' including applied loads and reactions.

l_{w_j} = overall length of the wall along the section 'j'.

d_{x_j} = $0.8l_{w_j}$ (ACI 318-08, 11.9.4, ACI 318-05/02, 11.10.4).

²⁴ ACI 318-14, 11.5.4.3, 11.5.4.2, 10.5.1.1, 11.4.3.1, 11.5.1.1, 11.5.4.4; ACI 318-11, 11.9.3, 11.9.4, 11.1.1; ACI 318-08 11.9.3, 11.9.4, 11.1.1

²⁵ ACI 318-05, 11.10.3, 11.10.4, 11.2.1, 11.1.1; ACI 318-02, 11.10.3, 11.10.4, 11.2.1, 11.1.1

2.7.2.2. Wall Shear Strength Provided by Concrete – Out-of-plane

Simplified Equations

Out-of-plane shear strength provided by section ‘j’ in a uniform or non-uniform concrete wall is calculated using the following equations²⁶:

$$V_{cz_j} = \begin{cases} 2 \left(1 + \frac{N_{wy_j}}{2000 A_{g_j}} \right) \sum_{i=1}^n \lambda \sqrt{f'_{c_{j_i}}} l_{w_j} d_{z_{j_i}} & \text{if } N_{wy_j} > 0, \text{ (compression)} \\ 2 \sum_{i=1}^n \lambda \sqrt{f'_{c_{j_i}}} l_{w_j} d_{z_{j_i}} & \text{if } N_{wy_j} = 0 \\ 0 & \text{if } N_{wy_j} < 0, \text{ (tension)} \end{cases}$$

Where:

$d_{z_{j_i}}$ = distance in Z-direction from extreme compression fiber to centroid of vertical tension reinforcement of the wall element “i” the section ‘j’ (may depend on the sign of M_{u_x} if vertical reinforcement layers are not placed symmetrically).

l_{w_j} = overall length of the wall along the section ‘j’.

$\sqrt{f'_{c_{j_i}}}$ = square root of specified compressive strength of concrete for the wall element “i” along the section ‘j’. The value shall not exceed 100 psi.

A_{g_j} = gross area of concrete section ‘j’.

²⁶ ACI 318-14, 22.5.5.1, 22.5.6.1, 22.5.7.1, 11.5.4.6; ACI 318-11, 11.2.1, 11.2.2.3; ACI 318-08, 11.2.1, 11.2.2.3; ACI 318-05, 11.3.1, 11.3.2.3; ACI 318-02, 11.3.1, 11.3.2.3

Detailed Equations

The detailed calculation of in-plane shear strength is allowed by the program for uniform concrete walls based on the following equations²⁷ where:

$$V_{cz_j} = \left\{ \begin{array}{l} \min \left[\left(\begin{array}{l} 1.9\lambda\sqrt{f'_{c_j}} + 2500\rho_{w_j} \frac{V_{uz_j} d_{z_j}}{M_{ux_j} - N_{wy_j} \frac{4h_{z_j} - d_{z_j}}{8}} \\ 3.5\lambda\sqrt{f'_{c_j}} l_{w_j} d_{z_j} \sqrt{1 + \frac{N_{wy_j}}{500A_{g_j}}} \end{array} \right) l_{w_j} d_{z_j} \right] \quad \begin{array}{l} \text{if } N_{wy_j} > 0, \text{ (compression)} \\ \text{and} \\ M_{ux_j} - N_{wy_j} \frac{4h_{z_j} - d_{z_j}}{8} > 0 \end{array} \\ \\ 3.5\lambda\sqrt{f'_{c_j}} l_{w_j} d_{z_j} \sqrt{1 + \frac{N_{wy_j}}{500A_{g_j}}} \quad \begin{array}{l} \text{if } N_{wy_j} > 0, \text{ (compression)} \\ \text{and} \\ M_{ux_j} - N_{wy_j} \frac{4h_{z_j} - d_{z_j}}{8} \leq 0 \end{array} \\ \\ \min \left[\left(\begin{array}{l} 1.9\lambda\sqrt{f'_{c_j}} + 2500\rho_{w_j} \min \left(\frac{V_{uz_j} d_{z_j}}{M_{ux_j}}, 1.0 \right) \\ 3.5\lambda\sqrt{f'_{c_j}} l_{w_j} d_{z_j} \end{array} \right) l_{w_j} d_{z_j} \right] \quad \text{if } N_{wy_j} = 0 \\ \\ 2\lambda\sqrt{f'_{c_j}} l_w d_{z_j} \left(1 + \frac{N_{wy_j}}{500A_{g_j}} \right) \quad \begin{array}{l} \text{if } (-500A_{g_j}) < N_{wy_j} < 0, \\ \text{(tension)} \end{array} \\ \\ 0 \quad \text{if } N_{wy_j} \leq -500A_{g_j} \end{array} \right.$$

²⁷ ACI 318-14, 22.5.6.1, 22.5.5.1, 22.5.7.1, 11.5.4.6; ACI 318-11, 11.2.2, 11.2.2.3; ACI 318-08, 11.2.2, 11.2.2.3; ACI 318-05, 11.3.2, 11.3.2.3; ACI 318-02, 11.3.2, 11.3.2.3

Where:

d_{z_j} = distance (in Z-axis direction) from extreme compression fiber to centroid of vertical tension reinforcement (may depend on the sign of M_{u_x} if vertical reinforcement layers are not placed symmetrically) along the section 'j' (above and below the horizontal grid line).

h_{z_j} = thickness of the wall in Z-direction along the section 'j'.

ρ_{w_j} = vertical tension reinforcement ratio along the section 'j' conservatively assumed by the program to be equal to the minimum vertical reinforcement ratio²⁸ of 0.0012.

²⁸ ACI 318-14, 11.6.1; ACI 318-11, 14.3.2; ACI 318-08, 14.3.2; ACI 318-05, 14.3.2; ACI 318-02, 14.3.2

2.7.3. Shear and Torsion Design of Stiffener Elements

For each of the design codes available in spWall, a summary of shear and torsion design requirements is given below:

2.7.3.1. ACI 318-14

- Definitions:

d = Distance from extreme compression fiber to centroid of longitudinal tension reinforcement. For a circular section $d \geq 0.8$ diameter.

b_w = Web width or diameter of circular section.

$$V_s = \frac{V_u}{\phi} - V_c \geq 0$$

$$T_n = \frac{T_u}{\phi}$$

- $\phi = 0.75$ (21.2.1)

- Maximum usable $f_{yt} = 60.0$ ksi (22.7.3.2, 22.7.3.3, 22.7.5.1)

- Lightweight concrete (19.2.4.1, 19.2.4.2, 19.2.4.3, 26.4.2.1(a)(10))

$\lambda = 1.0$, if $w_c \geq 135$ pcf (2155 kg / m³)

$\lambda = 0.85$, if 115 pcf (1840 kg / m³) $< w_c < 135$ pcf (2155 kg / m³)

$\lambda = 0.75$, if $w_c \leq 115$ pcf (1840 kg / m³) (2.3)

- Shear strength provided by concrete

$$V_c = 2 \left(1 + \frac{N_u}{2000 A_g} \right) \lambda \sqrt{f'_c} b_w d \quad N_u \geq 0 \text{ (compression)} \quad (22.5.6.1, 11.5.4.6)$$

$$V_c = 2 \left(1 + \frac{N_u}{500A_g} \right) \lambda \sqrt{f'_c} b_w d \geq 0 \quad N_u \leq 0 \text{ (tension)} \quad (22.5.7.1, 11.5.4.6)$$

- Shear reinforcement

- Shear reinforcement should be provided if $v_u > 0.5v_c$ (7.6.3.1, 9.6.3.1, 10.6.2.1)

- $\frac{A_v}{s} = \frac{V_s}{f_{yt}d}$ (7.6.3.2, 9.6.3.2)

- Maximum spacing of stirrups

$$0.5 d \leq 24 \text{ inches} \quad \text{for } V_s \leq 4\sqrt{f'_c} b_w d_v \quad (9.7.6.2.2, 10.7.6.5.2)$$

$$0.25 d \leq 12 \text{ inches} \quad \text{for } V_s > 4\sqrt{f'_c} b_w d_v \quad (9.7.6.2.2, 10.7.6.5.2)$$

- Torsion reinforcement

- Torsion reinforcement should be provided if

$$T_u > \phi \lambda \left(\frac{A_{cp}^2}{P_{cp}} \right) \sqrt{f'_c} \sqrt{1 + \frac{N_u}{4A_g \sqrt{f'_c}}} \quad (9.5.4.1, 22.7.1.1, 22.7.4.1)$$

- $\frac{A_t}{s} = \frac{T_n}{2A_o f_{yt}}$ (22.7.6.1, 22.7.6.1.1, 22.7.6.1.2)

- $A_t = \frac{A_t}{s} P_h \left(\frac{f_{yv}}{f_{yt}} \right)$ (22.7.6.1)

- Minimum $A_t = \frac{5\lambda \sqrt{f'_c} A_{cp}}{f_y} - \frac{A_t}{s} p_h \frac{f_{yt}}{f_y}$ for $\frac{A_t}{s} \geq \frac{25b_w}{f_{yt}}$ (9.6.4.3)

- Maximum spacing of stirrups

$$\frac{P_h}{8} \leq 12.0 \text{ inches} \quad (9.7.6.3.3)$$

- Minimum shear reinforcement

$$\text{Minimum} \left(\frac{A_v}{s} + 2 \frac{A_t}{s} \right) = 0.75 \lambda \sqrt{f'_c} \frac{b_w}{f_{yt}} \geq 50 \frac{b_w}{f_{yt}} \quad (9.6.4.2)$$

- Total shear stress
- Maximum shear stress

$$\sqrt{\left(\frac{V_u}{b_w d} \right)^2 + \left(\frac{T_u p_h}{1.7 A_{oh}^2} \right)} < \phi \left(\frac{V_c}{b_w d} + 8 \lambda \sqrt{f'_c} \right) \quad (22.7.7.1, 22.7.7.1.1)$$

2.7.3.2. ACI 318-11/08

- Definitions:

d = Distance from extreme compression fiber to centroid of longitudinal tension reinforcement. For a circular section $d \geq 0.8$ diameter.

b_w = Web width or diameter of circular section.

$$V_s = \frac{V_u}{\phi} - V_c \geq 0$$

$$T_n = \frac{T_u}{\phi}$$

- $\phi = 0.75$ (9.3.2.3)

- Maximum usable $f_{yt} = 60.0$ ksi (11.5.2)

- Lightweight concrete (8.6.1)

$\lambda = 1.0$, if $w_c \geq 135$ pcf (2155 kg / m³)

$\lambda = 0.85$, if 115 pcf (1840 kg / m³) $< w_c < 135$ pcf (2155 kg / m³)

$\lambda = 0.75$, if $w_c \leq 115$ pcf (1840 kg / m³)

- Shear strength provided by concrete:

$$V_c = 2 \left(1 + \frac{N_u}{2000A_g} \right) \lambda \sqrt{f'_c} b_w d \quad N_u \geq 0 \text{ (compression)} \quad (11.2.1.2)$$

$$V_c = 2 \left(1 + \frac{N_u}{500A_g} \right) \lambda \sqrt{f'_c} b_w d \geq 0 \quad N_u \leq 0 \text{ (tension)} \quad (11.2.2.3)$$

- Shear reinforcement

- Shear reinforcement should be provided if $v_u > 0.5v_c$ (11.4.6.1)

- $$\frac{A_v}{s} = \frac{V_s}{f_{yt}d} \quad (11.4.6.2)$$

- Maximum spacing of stirrups

$$0.5 d \leq 24 \text{ inches} \quad \text{for } V_s \leq 4\sqrt{f'_c}b_wd_v \quad (11.4.5.1)$$

$$0.25 d \leq 12 \text{ inches} \quad \text{for } V_s > 4\sqrt{f'_c}b_wd_v \quad (11.4.5.3)$$

- Torsion reinforcement

- Torsion reinforcement should be provided if

$$T_u > \phi\lambda \left(\frac{A_{cp}^2}{P_{cp}} \right) \sqrt{f'_c} \sqrt{1 + \frac{N_u}{4A_g\sqrt{f'_c}}} \quad (11.5.1(c))$$

- $$\frac{A_t}{s} = \frac{T_n}{2A_o f_{yt}} \quad (11.5.3.6)$$

- $$A_t = \frac{A_t}{s} P_h \left(\frac{f_{yv}}{f_{yt}} \right) \quad (11.5.3.7)$$

- Minimum
$$A_t = \frac{5\lambda\sqrt{f'_c}A_{cp}}{f_y} - \frac{A_t}{s} p_h \frac{f_{yt}}{f_y} \quad \text{for } \frac{A_t}{s} \geq \frac{25b_w}{f_{yt}} \quad (11.5.5.3)$$

- Maximum spacing of stirrups

$$\frac{P_h}{8} \leq 12.0 \text{ inches} \quad (11.5.6.1)$$

- Minimum shear reinforcement

$$\text{Minimum} \left(\frac{A_v}{s} + 2 \frac{A_t}{s} \right) = 0.75\lambda\sqrt{f'_c} \frac{b_w}{f_{yt}} \geq 50 \frac{b_w}{f_{yt}} \quad (11.5.5.2)$$

- Total shear stress

- Maximum shear stress

$$\sqrt{\left(\frac{V_u}{b_w d}\right)^2 + \left(\frac{T_u p_h}{1.7 A_{oh}^2}\right)} < \phi \left(\frac{V_c}{b_w d} + 8\lambda \sqrt{f'_c} \right) \quad (11.5.3.1)$$

2.7.3.3. ACI 318-05

- Definitions:

d = Distance from extreme compression fiber to centroid of longitudinal tension reinforcement. For a circular section $d \geq 0.8$ diameter.

b_w = Web width or diameter of circular section.

$$V_s = \frac{V_u}{\phi} - V_c \geq 0$$

$$T_n = \frac{T_u}{\phi}$$

- $\phi = 0.75$ (9.3.2.3)

- Maximum usable $f_{yt} = 60.0$ ksi (11.5.2)

- Lightweight concrete (11.2.1.2)

$\lambda = 1.0$, if $w_c \geq 135$ pcf (2155 kg / m³)

$\lambda = 0.85$, if 115 pcf (1840 kg / m³) $< w_c < 135$ pcf (2155 kg / m³)

$\lambda = 0.75$, if $w_c \leq 115$ pcf (1840 kg / m³)

- Shear strength provided by concrete

$$V_c = 2 \left(1 + \frac{N_u}{2000 A_g} \right) \lambda \sqrt{f'_c} b_w d \quad N_u \geq 0 \text{ (compression)} \quad (11.3.1.2)$$

$$V_c = 2 \left(1 + \frac{N_u}{500 A_g} \right) \lambda \sqrt{f'_c} b_w d \geq 0 \quad N_u \leq 0 \text{ (tension)} \quad (11.3.2.3)$$

- Shear reinforcement

- Shear reinforcement should be provided if $v_u > 0.5v_c$ (11.5.5.1)

- $$\frac{A_v}{s} = \frac{V_s}{f_{yt}d} \quad (11.5.6.2)$$

- Maximum spacing of stirrups

$$0.5 d \leq 24 \text{ inches} \quad \text{for } V_s \leq 4\sqrt{f'_c}b_wd_v \quad (11.5.4.1)$$

$$0.25 d \leq 12 \text{ inches} \quad \text{for } V_s > 4\sqrt{f'_c}b_wd_v \quad (11.5.4.3)$$

- Torsion reinforcement

- Torsion reinforcement should be provided if

$$T_u > \phi\lambda \left(\frac{A_{cp}^2}{P_{cp}} \right) \sqrt{f'_c} \sqrt{1 + \frac{N_u}{4A_g\sqrt{f'_c}}} \quad (11.6.1(c))$$

- $$\frac{A_t}{s} = \frac{T_n}{2A_o f_{yt}} \quad (11.6.3.6)$$

- $$A_t = \frac{A_t}{s} P_h \left(\frac{f_{yv}}{f_{yt}} \right) \quad (11.6.3.7)$$

- Minimum
$$A_t = \frac{5\lambda\sqrt{f'_c}A_{cp}}{f_y} - \frac{A_t}{s} p_h \frac{f_{yt}}{f_y} \quad \text{for } \frac{A_t}{s} \geq \frac{25b_w}{f_{yt}} \quad (11.6.5.3)$$

- Maximum spacing of stirrups

$$\frac{P_h}{8} \leq 12.0 \text{ inches} \quad (11.6.6.1)$$

- Minimum shear reinforcement

$$\text{Minimum} \left(\frac{A_v}{s} + 2 \frac{A_t}{s} \right) = 0.75\lambda\sqrt{f'_c} \frac{b_w}{f_{yt}} \geq 50 \frac{b_w}{f_{yt}} \quad (11.6.5.2)$$

- Total shear stress

- Maximum shear stress

$$\sqrt{\left(\frac{V_u}{b_w d}\right)^2 + \left(\frac{T_u p_h}{1.7 A_{oh}^2}\right)} < \phi \left(\frac{V_c}{b_w d} + 8\lambda \sqrt{f'_c} \right) \quad (11.6.3.1)$$

2.7.3.4. ACI 318-02

- Definitions:

d = Distance from extreme compression fiber to centroid of longitudinal tension reinforcement. For a circular section $d \geq 0.8$ diameter.

b_w = Web width or diameter of circular section.

$$V_s = \frac{V_u}{\phi} - V_c \geq 0$$

$$T_n = \frac{T_u}{\phi}$$

- $\phi = 0.75$ (9.3.2.3)

- Maximum usable $f_{yv} = 60.0$ ksi (11.5.2)

- Lightweight concrete (11.2.1.2)

$\lambda = 1.0$, if $w_c \geq 135$ pcf (2155 kg / m³)

$\lambda = 0.85$, if 115 pcf (1840 kg / m³) $< w_c < 135$ pcf (2155 kg / m³)

$\lambda = 0.75$, if $w_c \leq 115$ pcf (1840 kg / m³)

Linear relationship between w_c and λ is assumed between the above mentioned values.

- Shear strength provided by concrete

$$V_c = 2 \left(1 + \frac{N_u}{2000 A_g} \right) \lambda \sqrt{f'_c} b_w d \quad N_u \geq 0 \text{ (compression)} \quad (11.3.1.2)$$

$$V_c = 2 \left(1 + \frac{N_u}{500 A_g} \right) \lambda \sqrt{f'_c} b_w d \geq 0 \quad N_u \leq 0 \text{ (tension)} \quad (11.3.2.3)$$

- Shear reinforcement

- Shear reinforcement should be provided if $v_u > 0.5v_c$ (11.5.5.1)

- $$\frac{A_v}{s} = \frac{V_s}{f_{yv}d}$$
 (11.5.6.2)

- Maximum spacing of stirrups

$$0.5 d \leq 24 \text{ inches} \quad \text{for } V_s \leq 4\sqrt{f'_c}b_wd_v \quad (11.5.4.1)$$

$$0.25 d \leq 12 \text{ inches} \quad \text{for } V_s > 4\sqrt{f'_c}b_wd_v \quad (11.5.4.3)$$

- Torsion reinforcement

- Torsion reinforcement should be provided if

$$T_u > \phi\lambda \left(\frac{A_{cp}^2}{P_{cp}} \right) \sqrt{f'_c} \sqrt{1 + \frac{N_u}{4A_g\sqrt{f'_c}}} \quad (11.6.1(c))$$

- $$\frac{A_t}{s} = \frac{T_n}{2A_o f_{yv}}$$
 (11.6.3.6)

- $$A_t = \frac{A_t}{s} P_h \left(\frac{f_{yv}}{f_{yl}} \right)$$
 (11.6.3.7)

- Minimum $A_t = \frac{5\lambda\sqrt{f'_c}A_{cp}}{f_{yl}} - \frac{A_t}{s} p_h \frac{f_{yv}}{f_{yl}}$ for $\frac{A_t}{s} \geq \frac{25b_w}{f_{yv}}$ (11.6.5.3)

- Maximum spacing of stirrups

$$\frac{p_h}{8} \leq 12.0 \text{ inches} \quad (11.6.6.1)$$

- Minimum shear reinforcement

$$\text{Minimum} \left(\frac{A_v}{s} + 2 \frac{A_t}{s} \right) = 0.75\lambda\sqrt{f'_c} \frac{b_w}{f_{yv}} \geq 50 \frac{b_w}{f_{yv}} \quad (11.6.5.2)$$

- Total shear stress
- Maximum shear stress

$$\sqrt{\left(\frac{V_u}{b_w d}\right)^2 + \left(\frac{T_u p_h}{1.7 A_{oh}^2}\right)} < \phi \left(\frac{V_c}{b_w d} + 8\lambda \sqrt{f'_c} \right) \quad (11.6.3.1)$$

2.7.3.5. CSA A23.3-14/04 (Simplified Method)

- Definitions:

d = Distance from extreme compression fiber to centroid of longitudinal tension reinforcement. For a circular section, distance from extreme compression fiber to centroid of longitudinal reinforcement in the opposite half.

h = Overall height of member.

d_v = Greater of $0.9d$ and $0.72h$

b_w = Web width or diameter of circular section. (11.2.10.3)

$$V_s = V_f - V_c \geq 0 \quad v_c = \frac{V_c}{b_w d_v} \quad v_f = \frac{V_f}{b_w d_v}$$

$$\tau_c = \left(\frac{T_f P_{cp}}{A_{cp}^2} \right) \quad \tau_f = \left(\frac{T_f P_h}{A_{oh}^2} \right)$$

- $\phi_c = 0.65$ (8.4.2)

$\phi_c = 0.70$ for precast concrete (16.1.3)

$\phi_s = 0.85$ (8.4.3)

- Maximum usable $f'_c = 60$ MPa (11.3.6.3)

- Maximum usable $f_y = 400$ MPa (11.3.6.3)

- Lightweight concrete (2.1, 8.6.5)

$\lambda = 1.0$, if $w_c \geq 2150$ kg / m³ (134.2 pcf)

$\lambda = 0.85$, if 1850 kg / m³ (115.5 pcf) $< w_c < 2150$ kg / m³ (134.2 pcf)

$\lambda = 0.75$, if $w_c \leq 1850$ kg / m³ (115.5 pcf)

- Shear strength provided by concrete (assuming no significant tension):

$$V_c = \phi_c \lambda \beta \sqrt{f'_c} b_w d_v \quad (11.3.4)$$

where

$$\sqrt{f'_c} \leq 8 \text{ MPa}$$

$$\beta = 0.18 \text{ if at least minimum transverse reinforcement is provided} \quad (11.3.6(a))$$

$$\beta = \frac{230}{1000 + d_v} \text{ without transverse reinforcement} \quad (11.3.6(b))$$

- Shear reinforcement

- Shear reinforcement should be provided if $v_f > v_c$ (11.2.8.1)

- $\frac{A_v}{s} = \frac{V_s}{\phi_s f_y d_v}$ (11.3.5.1)

- Maximum spacing of stirrups

$$0.7 d_v \leq 600 \text{ mm} \quad \text{if } V_f \leq 0.125 \lambda \phi_c f'_c b_w d \text{ and } T_f \leq 0.25 T_{cr} \quad (11.3.8.1)$$

$$0.35 d_v \leq 300 \text{ mm} \quad \text{if } V_f > 0.125 \lambda \phi_c f'_c b_w d \text{ or } T_f > 0.25 T_{cr} \quad (11.3.8.3)$$

- Torsion reinforcement

- Torsion reinforcement should be provided if

$$T_f > 0.095 \phi_c \lambda \sqrt{f'_c} \frac{A_c^2}{p_c} \quad (11.2.9.1)$$

- $\frac{A_t}{s} = \frac{T_f}{2 A_o \phi_s f_y \cot 35^\circ}$ (11.3.10.3)

$$\bullet \quad A_{lt} = \frac{M_f / d_v + 0.5N_f + \cot 35^\circ \sqrt{(V_f - V_p)^2 + \left(\frac{0.45p_h T_f}{2A_o}\right)}}{\phi_s f_y} \quad (11.3.9.2, 11.3.10.6)$$

$$\bullet \quad A_{lb} = \frac{-M_f / d_v + 0.5N_f + \cot 35^\circ \sqrt{(V_f - V_p)^2 + \left(\frac{0.45p_h T_f}{2A_o}\right)}}{\phi_s f_y} \quad (11.3.9.3, 11.3.10.6)$$

- Minimum shear reinforcement

$$\left(\frac{A_v}{s} + 2\frac{A_t}{s}\right) \geq 0.06\sqrt{f'_c} \frac{b_w}{f_y} \quad (11.2.8.2)$$

- Cross-sectional dimensions to avoid crushing

$$\sqrt{\left(\frac{V_f}{b_w d_v}\right)^2 + \left(\frac{T_f p_h}{1.7A_{oh}^2}\right)^2} \leq 0.25\phi_c f'_c \quad (11.3.10.4)$$

- Maximum factored shear resistance

$$V_r \leq 0.25\phi_c f'_c b_w d \quad (11.3.3)$$

2.7.3.6. CSA A23.3-94 (Simplified Method)

- Definitions:

d = Distance from extreme compression fiber to centroid of longitudinal tension reinforcement. For a circular section, distance from extreme compression fiber to centroid of longitudinal reinforcement in the opposite half.

b_w = Web width or (0.8 diameter) of circular section. (11.2.10)

$$V_s = V_f - V_c \geq 0 \quad v_c = \frac{V_c}{b_w d} \quad v_f = \frac{V_f}{b_w d}$$

$$\tau_c = \left(\frac{T_f P_{cp}}{A_{cp}^2} \right) \quad \tau_f = \left(\frac{T_f P_h}{A_{oh}^2} \right)$$

- $\phi_c = 0.6$ (8.4.2)

$$\phi_s = 0.85 \quad (8.4.3)$$

- Maximum usable $f_y = 500$ MPa (8.5.1)

- Lightweight concrete (2.1, 8.6.5)

$$\lambda = 1.0, \text{ if } w_c \geq 2150 \text{ kg / m}^3 \text{ (134.2 pcf)}$$

$$\lambda = 0.85, \text{ if } 1850 \text{ kg / m}^3 \text{ (115.5 pcf)} < w_c < 2150 \text{ kg / m}^3 \text{ (134.2 pcf)}$$

$$\lambda = 0.75, \text{ if } w_c \leq 1850 \text{ kg / m}^3 \text{ (115.5 pcf)}$$

Linear relationship between w_c and λ is assumed between the above mentioned values.

- Shear strength provided by concrete:

$$V_c = 0.2 \lambda \phi_c \sqrt{f'_c} b_w d \quad N_f \geq 0 \text{ (compression)} \quad (11.3.5.1)$$

$$V_c = 0.2 \left(1 + \frac{N_f}{0.6 \lambda \phi_c \sqrt{f'_c} A_g} \right) \lambda \phi_c \sqrt{f'_c} b_w d \quad N_f < 0 \text{ (tension)}$$

(CSA A23.3-84/11.3.4.2)

- Shear reinforcement

- Shear reinforcement should be provided if $v_f > 0.5v_c$ (11.2.8.1)

- $$\frac{A_v}{s} = \frac{V_s}{\phi_s f_y d}$$
 (11.3.7)

- Maximum spacing of stirrups (11.2.11)

$$0.7 d \leq 600 \text{ mm} \quad \text{for } V_f < 0.1\lambda\phi_c f'_c b_w d$$

$$0.35 d \leq 300 \text{ mm} \quad \text{for } V_f \geq 0.1\lambda\phi_c f'_c b_w d$$

- Torsion reinforcement

- Torsion reinforcement should be provided if

$$T_f > 0.1\phi_c \lambda \sqrt{f'_c} \frac{A_c^2}{p_c} \quad (11.2.9.1)$$

- $$\frac{A_t}{s} = \frac{T_f}{2A_o\phi_s f_y}$$
 (11.3.9.4)

- $$A_t = \frac{A_t}{s} p_h$$
 (11.3.9.5)

- Maximum spacing of stirrups

$$\frac{p_h}{8} \leq 300 \text{ mm} \quad (\text{CSA A23.3-84/11.3.8.4})$$

- Minimum shear reinforcement

$$\left(\frac{A_v}{s} + 2 \frac{A_t}{s} \right) \geq 0.06 \sqrt{f'_c} \frac{b_w}{f_y} \quad (11.2.8.4)$$

- Cross-sectional dimensions to avoid crushing

$$\frac{V_f}{b_w d} + \frac{T_f p_h}{A_{oh}^2} \leq 0.25 \phi_c f'_c \quad (11.3.9.8)$$

- Maximum shear resistance

$$V_r \leq V_c + 0.8 \lambda \phi_c \sqrt{f'_c} b_w d \quad (11.3.4)$$

2.8. References

- [1] Building Code Requirements for Structural Concrete (ACI 318-14) and Commentary (ACI 318R-14), American Concrete Institute, 2014.
- [2] Building Code Requirements for Structural Concrete (ACI 318-11) and Commentary (ACI 318R-11), American Concrete Institute, 2011.
- [3] Building Code Requirements for Structural Concrete (ACI 318-08) and Commentary (ACI 318R-08), American Concrete Institute, 2008.
- [4] Building Code Requirements for Structural Concrete (ACI 318-05) and Commentary (ACI 318R-05), American Concrete Institute, 2005.
- [5] Building Code Requirements for Structural Concrete (ACI 318-02) and Commentary (ACI 318R-02), American Concrete Institute, 2002.
- [6] CSA A23.3-14, Design of Concrete Structures, Canadian Standards Association, 2014
- [7] CSA A23.3-04, Design of Concrete Structures, Canadian Standards Association, 2004.
- [8] CSA A23.3-94, Design of Concrete Structures, Canadian Standards Association, 1994.
- [9] Cook, Robert D., Malkus, David S., and Plesha, Michael E., Concepts and Applications of Finite Element Analysis, John Wiley & Sons, Third Edition, 1989.
- [10] Ghali, A.M. Neville, Structural Analysis, a Unified Classical and Matrix Approach, John Wiley & Sons, Fifth Edition, 2003.

CHAPTER

3

PROGRAM INTERFACE

3.1. Start Screen

When the Program is launched, a start screen appears as shown below. The Start Screen consists of options to start **New Project**, **Open** existing **Project**, open **Examples** folder, open **Templates**, links to available program **Resources** and a list of **Recent** files. The program name and copyright information are located in the bottom right of the start screen.

The screenshot shows the spWall software interface. The window title is "spWall - Untitled". The interface is divided into three main sections:

- Projects:** Contains options for "New project", "Open project", "Examples", and "Templates". Below "Templates" is a small icon representing a building structure.
- Recent:** Lists four recent projects with their full file paths:
 - Tiltup Wall with Opening and Roof, Wind and Seismic Loads.walx**
C:\Program Files (x86)\StructurePoint\spWall\Examples
 - Tiltup Wall 4-Story Building.walx**
C:\Program Files (x86)\StructurePoint\spWall\Examples
 - Shear Wall with Openings.walx**
C:\Program Files (x86)\StructurePoint\spWall\Examples
 - Shear Wall 9-Story Building.walx**
C:\Program Files (x86)\StructurePoint\spWall\Examples
- Resources:** Contains links for "Manual...", "Design Examples...", "Tutorial Videos..." (with a play button icon), "spWall Info...", "Submit a Question...", "Check for Updates...", "Release Notes...", and "About spWall".

At the bottom right, there is a "Clear all history" button and copyright information: "spWall v10.00 (TM) Copyright © 1988-2022, STRUCTUREPOINT, LLC."

3.2. Main Program Window

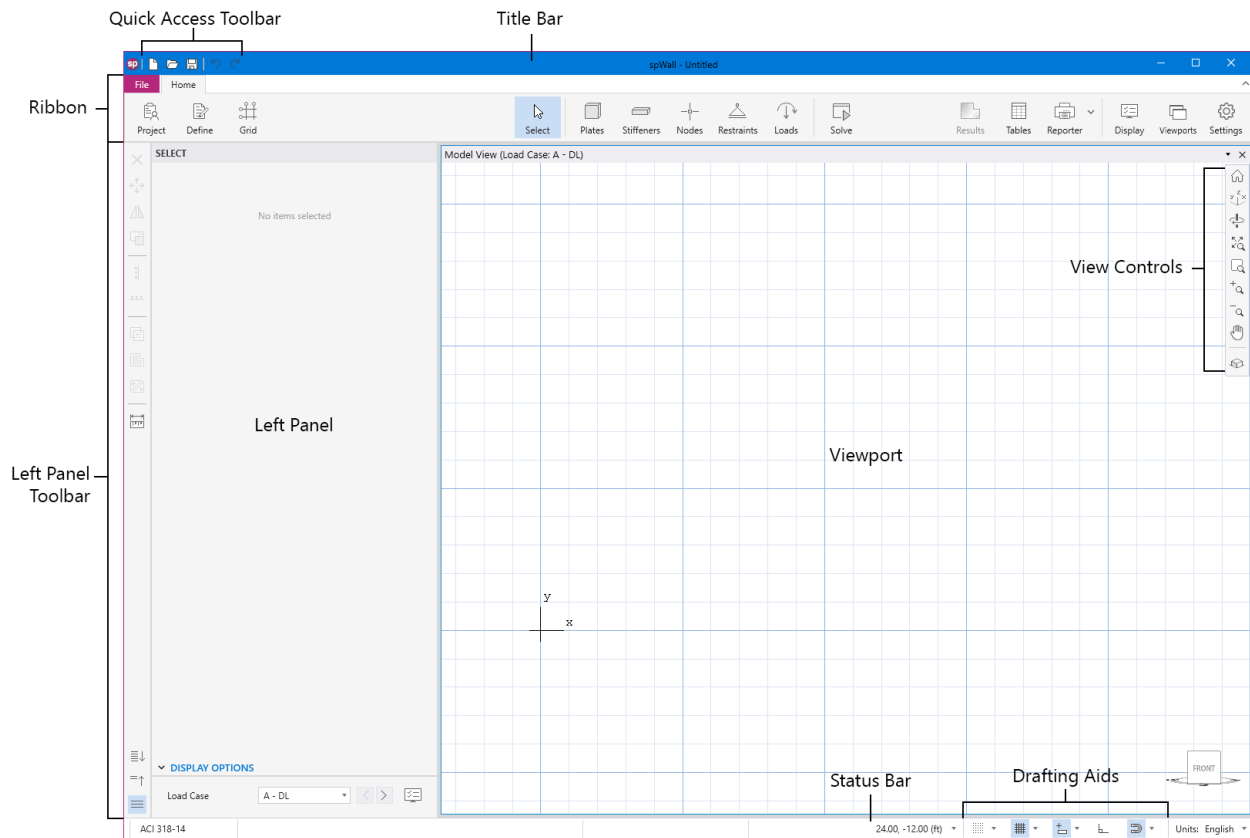

The **Main Program Window** shown above consists of the following:

Quick Access Toolbar

The **Quick Access Toolbar** includes **New**, **Open**, **Save** and **Undo** and **Redo** commands.

Title Bar

The **Title Bar** displays the name of the program, along with the filename of the current data file in use. If the file is new and has not yet been saved, the word "Untitled" is displayed in the **Title Bar**. It also displays "(Modified)" if the file has been changed and not saved yet.

Ribbon

The **Ribbon** consists **File** and **Home** tabs.

File Tab consists of commands to go **Back** to **Home** Tab, create **New** file, **Open** an existing file, **Save** a file, **Save as**, **Import**, **Export** and **Exit**. In addition, the entire **Start Screen** is present under the **File** Tab.

Home Tab gives quick access to commands which are needed to complete the task of creating a model, executing it and analyzing solutions. These commands are:

Project: enables to enter DESIGN CODE, UNIT SYSTEM, and PROJECT DESCRIPTION.

Define: enables to define **Plates** and **Stiffeners** objects; **Concrete**, **Reinforcement**, **Plate Cracking Coefficient**, **Plate Design Criteria**, **Stiffener Cracking Coefficient**, and **Stiffener Design Criteria** properties; **Supports** and **Springs** restraints; **Load Cases**, **Service** and **Ultimate Load Combinations**.

Grid: enables to add new or edit existing grids.

Select: enables to select various model items.

Plates: enables to create Rectangular, Circular or Polygon shaped plates.

Stiffeners: enables to create horizontal or vertical stiffeners.

Nodes: enables to create a single node or multiple nodes in a linear or circular pattern.

Restraints: enables to assign nodal springs, nodal supports, and linear supports to the model.

Loads: enables to assign point loads, uniform line loads, uniform area loads, and linear area loads to the model.

Solve: enables to specify solver options, mesh generation options, and solve the model.

Results: after a successful run, enables to view graphical results (contours or diagrams)

such as plate and stiffener internal forces, required reinforcements, and displacements.

Tables: enables to open Tables Module to view tabular input and output.

Reporter: enables to open Reporter Module to view the report.

Display: enables to toggle on/off model items.

Viewports: enables to select from a predefined viewport configuration.

Settings: enables to modify various program settings.

Left Panel

The properties of active commands under **Home** Tab or the properties of items selected in the **Viewport** are displayed in the **Left Panel** which can then be used to execute the commands or edit the selected items. After execution **Left Panel** also displays various solutions which can be explored using the **Viewport**.

Left Panel Toolbar

The **Left Panel Toolbar** contains commands that can be used to edit various items in the **Viewport**.

Viewport

The **Viewport** covers the majority of the main program window. It is the space where models can be created and graphical results can be viewed. Up to 6 **Viewports** can be used at once. Viewports can be moved and docked in a number of predefined locations using the docking tool. A viewport may be split out to a separate screen entirely for added flexibility and to enlarge the model view work area providing more accurate drafting controls.

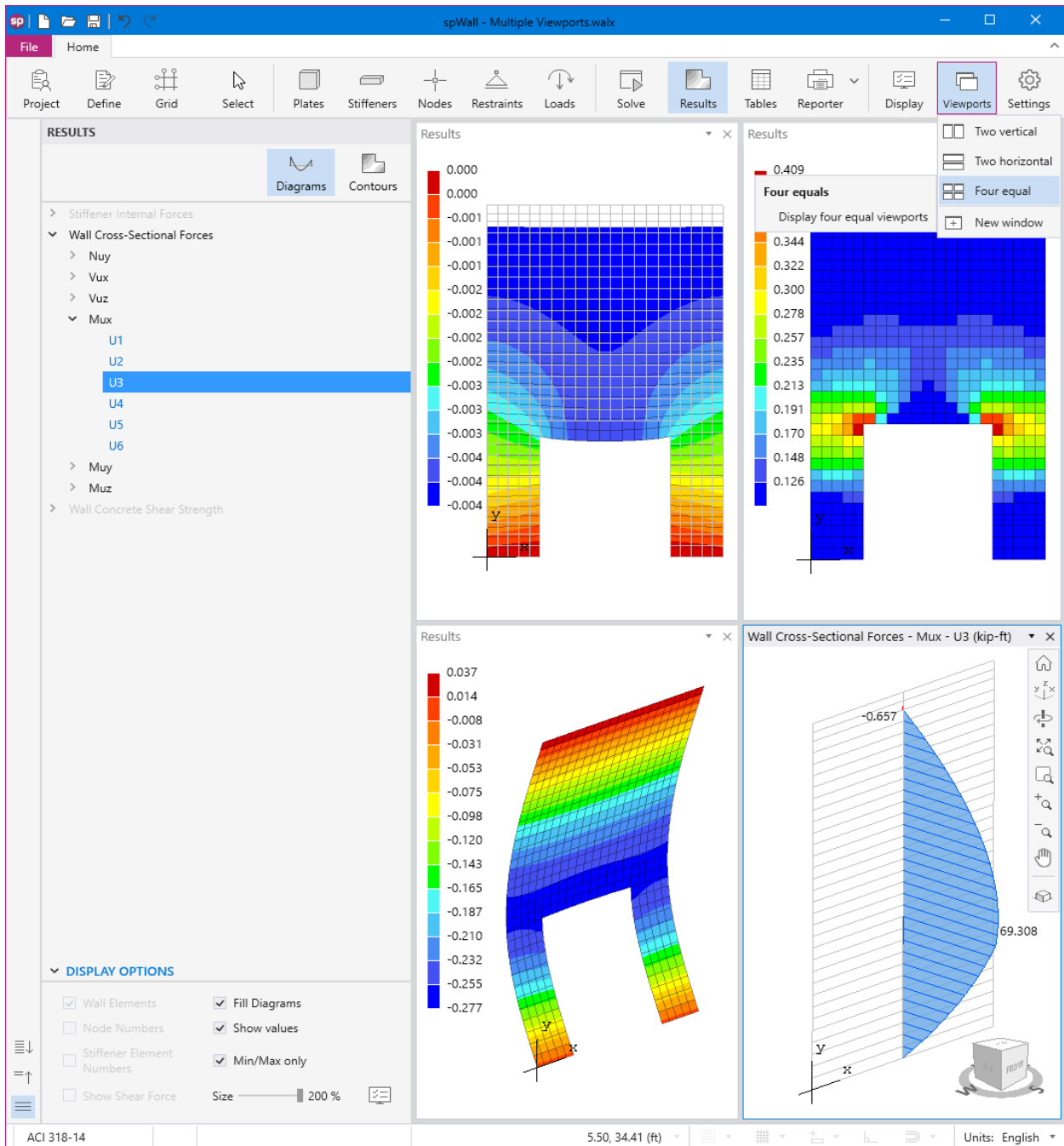

View Controls

The **View Controls** contains various commands which can be used to adjust the views of **Viewport** both during modeling or viewing the graphical results.

Drafting Aids

The **Drafting Aids** provides access to various **Viewport** and **Grid** parameters and commands which can facilitate in drafting a model.

Status Bar

The **Status Bar** displays important information such as the design code being used, cursor position and current units. It also houses the drafting aid commands.

3.3. Tables Window

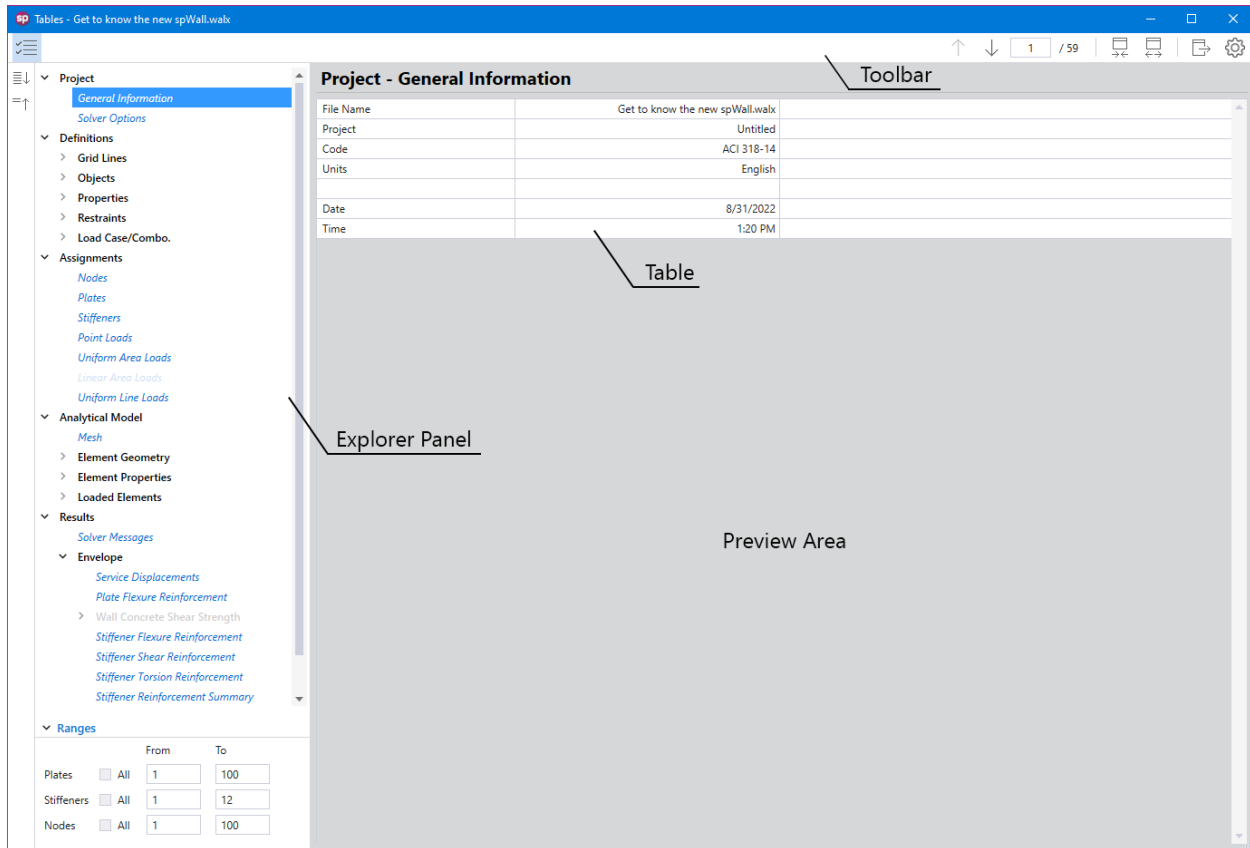

The **Tables Module** interface shown above enables the user to view program inputs and outputs in tables and export them in different formats.

The **Tables Module** is accessed from within the Main Program Window by clicking the **Tables** button from the **Ribbon**. Alternatively, **Tables Module** can also be accessed by pressing the F6 key. If the model has not been executed yet, then the **Tables Module** will only contain a list of input data tables. When a model has been successfully executed, the **Tables Module** will also display the output data tables.

Toolbar

The **Toolbar** contains commands which can be used to navigate through various Tables

Previous table

Displays the previous table.

Next table

Displays the next table.

Table number box

Displays the table with the table number entered in the box.

Auto fit column width to view area

When toggled on always fits the width of table to the **Preview Area** width.

Maintain maximum column width

Restores all table columns to their default maximum width.

Export current table

Exports the table being viewed in the selected format.

Settings

Contains settings for the **Explorer Panel**.

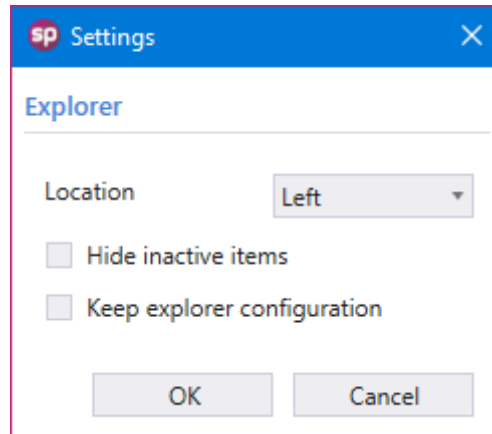

- **LOCATION:** Displays **Explorer Panel** on the left or right side of screen depending on selection.
- **HIDE INACTIVE ITEMS:** Hides unused tables from the explorer view.
- **KEEP EXPLORER CONFIGURATION:** Saves the explorer configuration i.e., information about selected tables and opened/closed sections so that it is available the next time user opens Tables Module.

Explorer

Shows or hides the **Explorer Panel**.

Explorer Panel

The **Explorer Panel** consists of all the available items of the inputs and results classified into sections and arranged hierarchically. Any item in the **Explorer Panel** can be clicked on to display the corresponding table in the **Preview Area**.

Expand all

Expands item list.

Collapse all

Collapses item list.

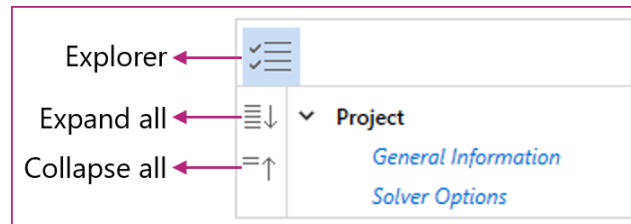

Ranges

		From	To
Plates	<input type="checkbox"/> All	<input type="text" value="1"/>	<input type="text" value="100"/>
Stiffeners	<input type="checkbox"/> All	<input type="text" value="1"/>	<input type="text" value="12"/>
Nodes	<input type="checkbox"/> All	<input type="text" value="1"/>	<input type="text" value="100"/>

The RANGES feature allows you to explore the results for a selected range of PLATES, STIFFENERS, and/or NODES. To view plate, stiffener, and nodal results for the entire model simply check the ALL checkbox. Alternatively, to view plate, stiffener, and nodal results within a range, make sure that the ALL checkbox is unchecked and enter the desired range in the FROM and TO text boxes.

3.4. Reporter Window

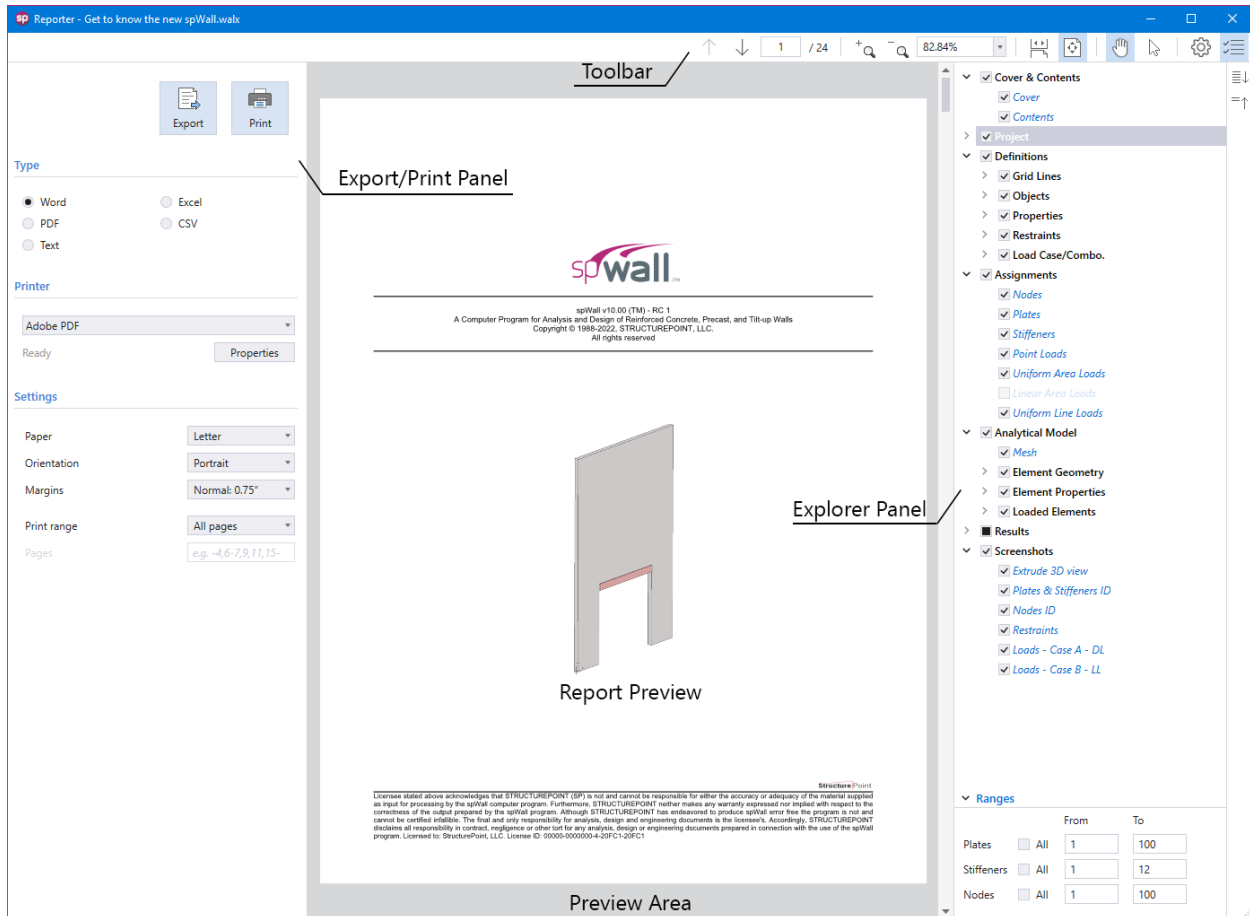

The **Reporter Module** interface shown above enables the user to view, customize, print and export reports in different formats.

The **Reporter Module** is accessed from within the Main Program Window by clicking the **Reporter** button from the **Ribbon**. Alternatively, **Reporter Module** can also be accessed by pressing the F7 key. If the model has not been solved then the **Reporter Module** will only contain a list of input data reports. When a model has been successfully executed, the **Reporter Module** will also display the output data reports. Immediately after opening the **Reporter Module**, you can export and/or print the default report by pressing **Export/Print** button. Various options to customize the report before printing and/or exporting it are also provided. Once the work in **Reporter Module** is complete, click the close button in the top right corner to exit **Reporter** window.

Toolbar

Previous page

Displays the previous page of the report.

Next page

Displays the next page of the report.

Page number box

Displays the page with the page number entered in the box.

Zoom in

Zooms in on the report (Ctrl + Mouse wheel up).

Zoom out

Zooms out on the report (Ctrl + Mouse wheel down).

Zoom box

Zooms on the report preview to the extent typed in the box or selected from the dropdown list.

Fit to window width and enable scrolling

Fits the width of report to the preview space width and enables scrolling.

Fit one full page to window

Fits one full page in the preview space.

Pan

When toggled on and report is bigger than preview window, enables panning the report.

Text selection

When toggled on enables selecting text in the report.

Settings

Modifies settings for **Report** and **Explorer Panel**.

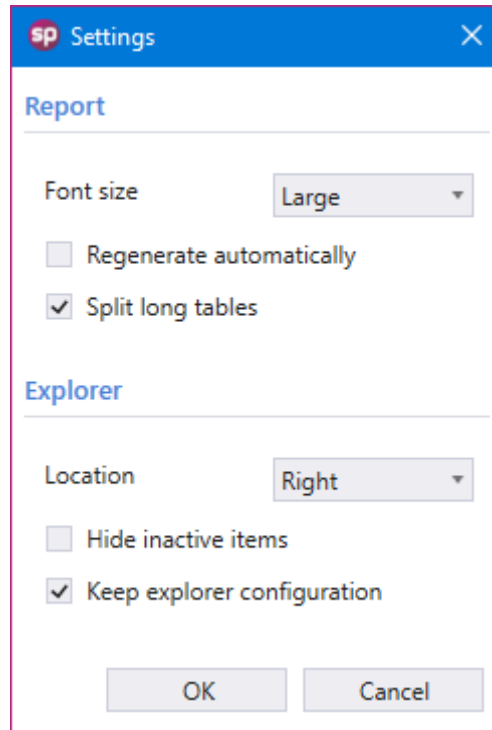

Report settings

- **FONT SIZE:** Provides the options to use small, medium or large font sizes in the report.
- **REGENERATE AUTOMATICALLY:** Enables automatic regeneration of report when content selection is modified by the user.
- **SPLIT LONG TABLES:** Displays table headings in all pages when tables are split along several pages.

Explorer settings

- **LOCATION:** Displays **Explorer Panel** on the left or right side of screen depending on selection.
- **HIDE INACTIVE ITEMS:** Hides unused tables from the explorer view.
- **KEEP EXPLORER CONFIGURATION:** Saves the explorer configuration i.e., information about selected tables and opened/closed sections so that it is available the next time user opens **Reporter**.

Explorer

Shows or hides the **Explorer Panel**.

Export / Print panel

Export

Exports the report in the selected format.

Print

Prints the report in the selected format when the option is available.

Type

Provides 5 format options to print and/or export the reports

- **WORD:** produces a Microsoft Word file with .docx extension.
- **PDF:** produces an Adobe Acrobat file with .pdf extension.
- **TEXT:** produces a Text file with .txt extension.
- **EXCEL:** produces a Microsoft Excel file with .xlsx extension.
- **CSV:** produces a Comma Separated file with .csv extension.

Printer

Provides the option to select available printers and change printer properties.

Settings

Provides the options to modify print settings.

- PAPER: Provides the options to select from available paper sizes.
- ORIENTATION: Provides the options to select between landscape or portrait paper orientation.
- MARGINS: Provides the options to use narrow, normal, wide or custom margins to the report

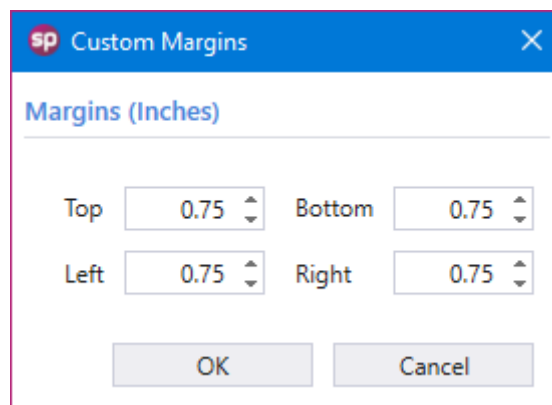

- PRINT RANGE: Provides the options to select the pages to print and/or export.

Explorer Panel

The **Explorer Panel** consists of all the available report items classified into sections and arranged hierarchically. Each item listed in the **Explorer Panel** is preceded by a checkbox. The user can check/uncheck the checkbox to include or exclude from the report, the items or sections.

Expand all

Expands item list.

Collapse all

Collapses item list

Ranges

		From	To
Plates	<input type="checkbox"/> All	1	100
Stiffeners	<input type="checkbox"/> All	1	12
Nodes	<input type="checkbox"/> All	1	100

The RANGES feature allows you to explore the results for a selected range of PLATES, STIFFENERS, and/or NODES. To view plate, stiffener, and nodal results for the entire model, simply check the ALL checkbox. Alternatively, to view plate, stiffener, and nodal results within a range, make sure that the ALL checkbox is unchecked and enter the desired range in the FROM and TO text boxes.

3.5. Print/Export Window

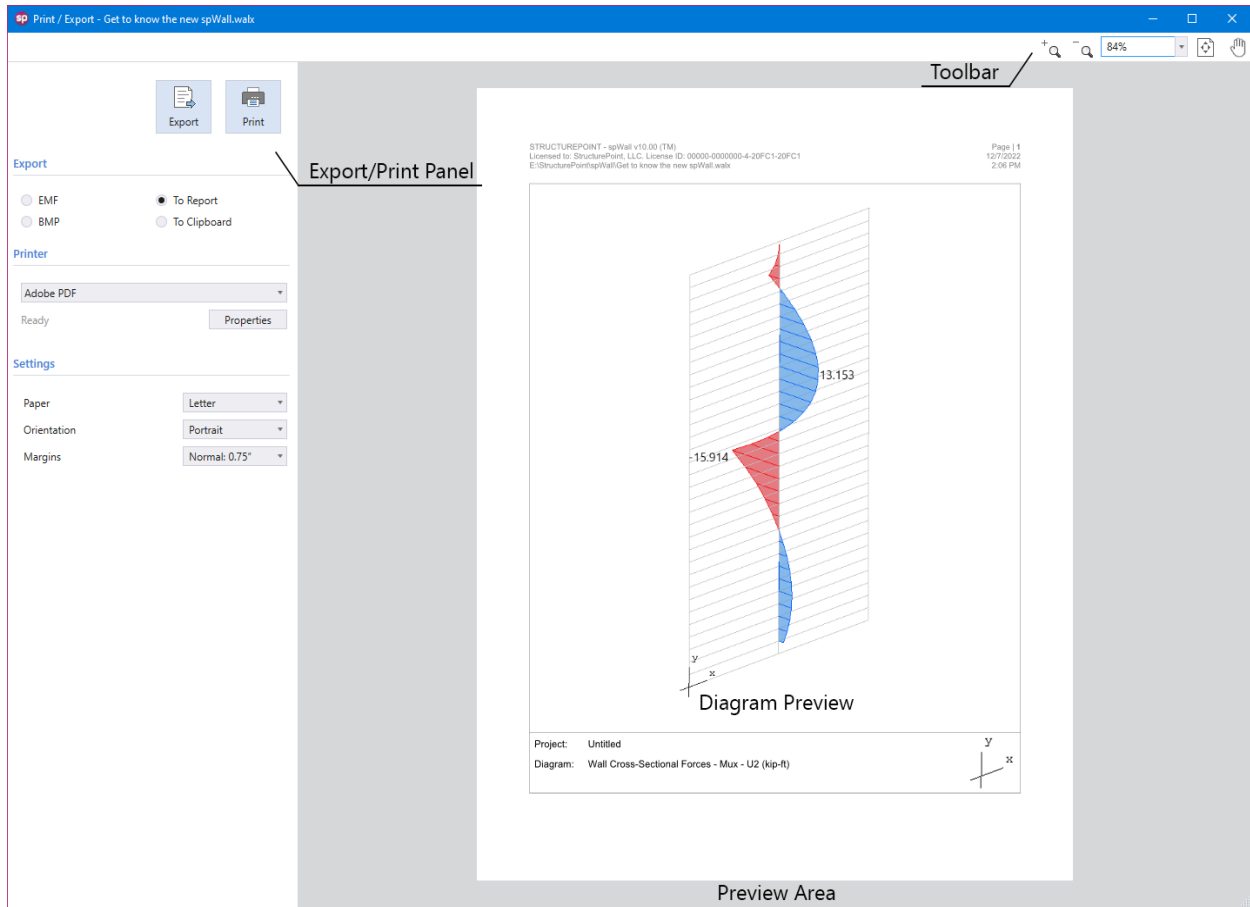

Print/Export Module interface shown above enables the user to view, customize, print and export contours and diagrams in different formats.

The **Print/Export Module** is accessed from within the **Main Program Window** by using the **Right Click Menu** or from the **Reporter Submenu** in the **Ribbon**.

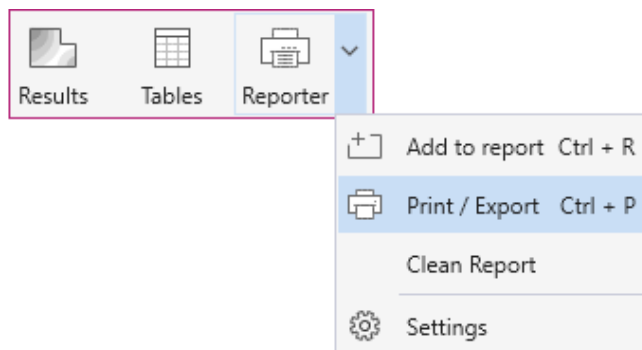
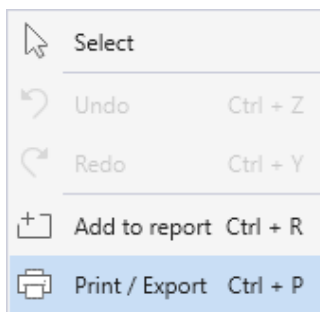

Alternatively pressing the “CTRL + P” also opens the **Print/Export Module**. Once the module is open the rest of the program is locked until the **Print/Export Module** is closed.

Immediately after opening the **Print/Export Module**, you can export and/or print the generated diagram by pressing **Export/Print** button. Options to customize the diagram orientation, paper size and margins are provided. Once the work in **Print/Export Module** is complete click the close button in the top right corner to exit the module.

Toolbar

Zoom in

Zooms in on the report (Ctrl + Mouse wheel up).

Zoom out

Zooms out on the report (Ctrl + Mouse wheel down).

Zoom box

Zooms on the report preview to the extent typed in the box or selected from the dropdown list.

Fit one full page to window

Fits one full page in the preview space.

Pan

When toggled on and report is bigger than preview window, enables panning the report.

Export / Print panel

Export

Exports the report in the selected format.

Print

Prints the displayed diagram.

Type

Provides 4 format options to export the reports

- EMF produces a file with .emf extension
- BMP produces a file with .bmp extension
- TO REPORT adds the diagram to the report
- TO CLIPBOARD copies the diagram to clipboard to be pasted elsewhere

Printer

Provides the option to select available printers and change printer properties.

Settings

Provides the options to modify print settings.

- PAPER: Provides the options to select from available paper sizes.
- ORIENTATION: Provides the options to select between landscape or portrait paper orientation.
- MARGINS: Provides the options to use narrow, normal, wide or custom margins to the report.

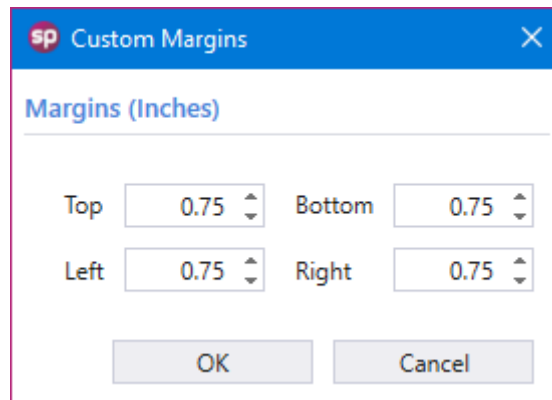

CHAPTER

4

MODELING METHODS

4.1. Model Creation Concepts

The key to successfully implementing spWall in a project is to understand the unique and powerful approach the program takes in modeling, analyzing, designing, and investigating a structural member subjected to in-plane and/or out-of-plane axial and/or flexural loads. This chapter provides an overview of assumptions and considerations the design professional must take into account while utilizing spWall.

As a general rule, the geometry of the analytical model shall correspond to that of the physical member as closely as possible.

The user shall ensure the project criteria aligns correctly with applicable design code and standard provisions on subjects such as load type, load factors, load combinations, material properties, design criteria, and cracking coefficient to name a few.

4.1.1. Physical Modeling Terminology

In spWall, reference is often made to objects, members, and elements. Objects represent the physical structural members in the model. Elements, on the other hand, refer to the finite elements used internally by spWall to generate the stiffness matrices. In many cases, objects and physical members will have a one-to-one correspondence, and it is these objects that the user draws in the spWall interface. Objects are intended to be an accurate representation of the physical members. Users typically need not concern themselves with the meshing of these objects into the elements required for the mathematical, or analysis finite element model. For example, a single area object can model an entire plate, regardless of the number of spans and variety of loads. With spWall, both model creation, as well as the reporting of results, is achieved at the object level.

This differs from a traditional approach in previous versions of the program, where the user is required to define a sub-assembly of finite elements that comprise the larger physical members. In spWall, the objects, or physical members drawn by the user, are automatically meshed internally prior to the analysis, into the greater number of finite elements needed for the analysis model, without user input. Because the user is working only with the physical member-based objects, less time is required both to create the model and interpret the results. The user, however, can dictate several meshing criteria after examination of the automatic mesh proposed by the program.

It is extremely important that you grasp the concept of objects in a structural model as it is the basis for creating models in spWall. After you understand the concept and have worked with it for a while, you should recognize the simplicity of physical object-based modeling, the ease with which you can create models using objects, and the power of the concept when editing and creating complex models.

4.1.2. Structural Objects

The spWall program uses objects to represent physical structural members. When creating a model, start by drawing the geometry using drawing area common Computer-Aided Design (CAD) tools and then assign properties and loads to completely define the structure.

The following object types are available, listed in descending order of geometrical dimension:

- **Plate/Area objects** are used to model plates, openings, and area loads
- **Stiffener objects** are used to model stiffeners, null stiffeners, linear restraints, and line loads
- **Node objects** are automatically created at the corners or ends of all other types of objects and also can be added manually anywhere in the model. Node objects are used to model point loads as well as for applying point restraints and springs.

As a general rule, the geometry of the object should correspond to that of the physical member as much as possible. This simplifies the visualization of the model and reduces the chances of input error. However, engineers can omit small changes in shape and geometry where added model accuracy or complexity is not consequential to the analysis & design results. A great deal of engineering judgment is involved in the conversion of a physical structure into an analytical model. However, significant gains can be achieved by keeping model simple & practical to the extent possible.

4.1.3. Properties

Properties are assigned to each object to define the structural behavior of that Plate/Area and/or Stiffener object in the model. Properties under the **Definitions window**, namely concrete, reinforcement, plate cracking coefficient, plate design criteria, stiffener cracking coefficient, and stiffener design criteria properties, are named entities that must be specified before assigning them to objects. If a property is assigned to an object, for example a plate design criteria property, any changes to the definition of the property will automatically apply to the plate objects with this property assigned. A named property has no effect on the model unless it is assigned to an object.

4.1.4. Input Preparation

The first step in preparing the input is to draw a scaled elevation view of the wall. The elevation view should include the boundaries of the plate and/or stiffeners, variations in the plate thickness and material properties, and openings within the plate. All superimposed loads applied on the plate and/or stiffeners should also be added. Structural grids and drawing area tools should be used to speed input preparation.

The next step is to select suitable mesh criteria including the maximum allowed mesh size, the maximum allowed aspect ratio, and the number of segments the circumference of a circular plate (if any) is to be divided in. Based on these parameters, plate and stiffeners boundaries, and point loads, the program automatically creates the most suitable mesh to use for the FEM analysis.

The user can increase or decrease the mesh density by changing the maximum allowed mesh size. A well-graded mesh will produce results which will effectively capture the variations of the displacements and element forces. While the use of finer meshes will generally produce more accurate results, it will also require more solution time, computer memory, and disk space. Elements with aspect ratios (length/width) near unity are generally expected to produce accurate results for regions having gradual changes of curvature. For plate regions where heavy concentrated forces are applied and where drastic changes in geometry exist, the use of finer element meshes may be required. Thus, in order to obtain a practical as well as accurate analytical solution, engineering judgment must be used.

The member nodal incidences are internally computed by the program. All nodes and members are numbered from left to right (in the positive X-direction) and from bottom to top (in the positive Y-direction), as shown in [Figure 4.1](#). When the reference grid system and/or assembling of elements is modified, the program internally renumbers all nodes and elements. In order to save solution time, memory, and disk space, it is recommended to position the side of the plate with fewer nodes (i.e., fewer degrees of freedom) parallel to the X-direction.

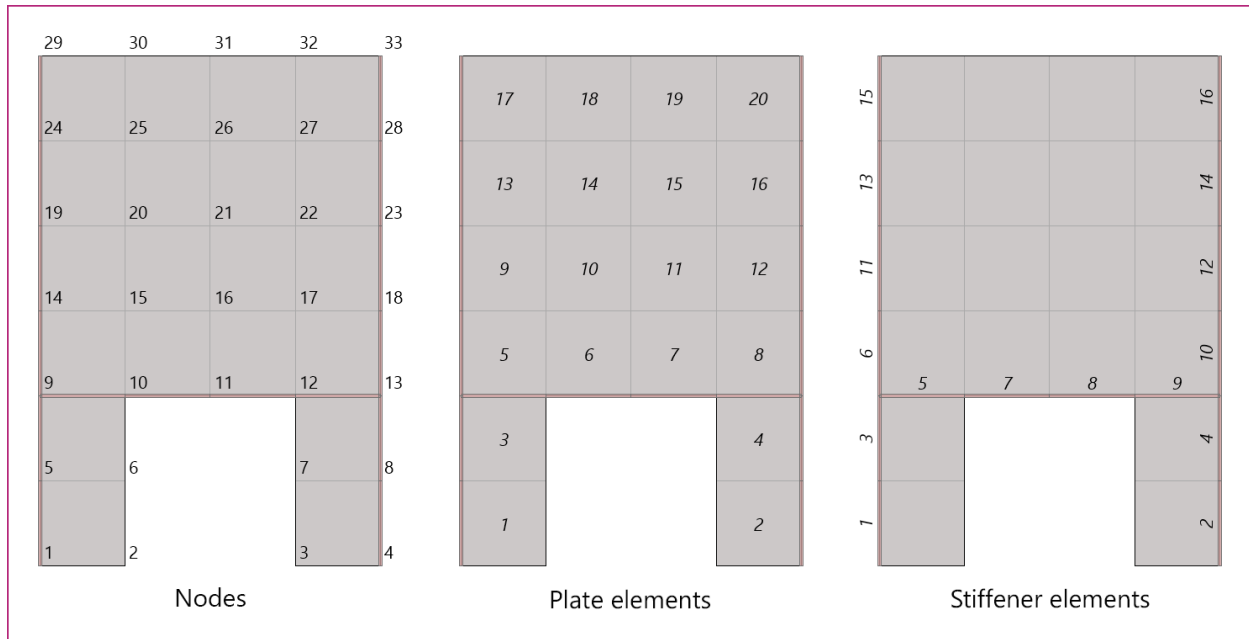

Figure 4.1 – Node and Element Numbering in Analytical Model

4.1.5. Modeling Considerations

As a multipurpose analysis program, spWall is used in many structural and architectural systems ([Section 2.1.1](#)) that warrant special consideration when constructing the analytical model. The engineer has to consider the unique aspects of a wall system type, usage, loading application and several other factors. Commonly, additional consideration is given to temporary loading conditions arising from lifting, shipping, erecting, shoring, or bracing for a wall or panel. The presence of temporary or permanent joints, reductions in wall cross-section, architectural reveals, anchored plate, and weldments is also important to consider in the construction of a successful wall model. In liquid-containing concrete tanks, manholes, swimming pools and other underground wall systems, the counteracting effects of active fluid and passive soil pressures can be a key consideration in the model. The sections below highlight a few of many important considerations for spWall users to be aware of.

4.1.5.1. Dock Door Restraints at Floor Slab

In warehouse and big box construction, reinforced concrete wall panels are used in what is commonly referred to as the “Rigid Wall Flexible Diaphragm” (RWFD) structural system. In RWFD construction, the wall panel is supported on grade beams or other foundation systems at a distance below the floor slab elevation. When the floor slab at grade is cast after wall erection it is dowelled into the concrete wall and provides another diaphragm support several feet above the vertical support at the foundation elevation. The wall panel becomes a two-span beam with hinged support at the base and two lateral restraints at the roof and slab on grade diaphragms. This condition changes the traditional behavior of the wall generally simplified into a single span simply supported between the roof and the foundation. The fixity generated by the restraining force couple at the wall base along with any parapet cantilevering above the roof level generates negative moments that must be evaluated and designed for by the engineer. In many cases, this alters the wall behavior sufficiently to exclude such wall panels from the limitations imposed by simplified analysis methods provided for simple span wall panels and complicates the computation of the second-order effects.

4.1.5.2. Wind Loads on Doors and Windows Openings

Wall panels that contain openings for windows, doors, dock doors, and other penetration for MEP equipment and appurtenances are very common in precast and tilt-up construction. Lateral forces from wind and seismic forces are normally applied as an area load to the entire wall. However, at opening locations, the engineer has to determine the magnitude and location of the concentrated and line load to replace the equivalent lateral force applied to the opening area covered by door or window system. A clear understanding of how the opening is covered and the attachment mechanism will dictate the loads to be applied to the wall analytical model to properly account for both gravity and lateral loads at opening locations.

4.1.5.3. Roof Joist Load Applications

Reinforced concrete wall panels are commonly used to carry gravity loads to the foundations. Roof systems made with open web steel joists, trusses, and single and double tee precast girders deliver their reactions to the wall panel as concentrated loads at a set recurring spacing along the roof line. Similarly, intermediate floor systems with steel or concrete beams deliver similar concentrated point load to the wall at various elevations. The concentrated loads are frequently replaced with an equivalent uniform line load normally deemed to satisfy the analysis and design intent of the panel. It is important to verify this modeling assumption where it is used for applicability based on the size and shape of the wall panels. The presence of loads near and edge of an opening may influence the ability of the point load to distribute uniformly and in such cases using the exact point load magnitude and location may be advisable.

4.1.5.4. Modeling of Roof Diaphragm Restraints

Horizontal diaphragms at the roof, floor, and other locations along the height of a reinforced concrete wall is used to provide lateral stability for the wall. Modeling such restraint is commonly intended to restrain out-of-plane deflection and provide stability in the minor axis of the wall. Where restraint in-plane is combined with out-of-plane is required, special care should be taken to ensure the restraint and the corresponding reactions are accounted for in the reinforcement design and detailing of the wall.

4.2. Model Editing Concepts

During the course of creating a model, it may be necessary to edit the model. This can be done through the **Select** button in the **Ribbon**. Then, any object that is present on the active **Viewport** can be selected and edited by the tools available within the **Left Panel Toolbar** and **Left Panel**. The editing tools at the **Left Panel Toolbar** can also be invoked by right-clicking the mouse button in the active **Viewport**. The editing tools that are available at the **Left Panel Toolbar** per Object are:

- **Plate Object:** Plate objects can be deleted, moved, mirrored, duplicated, merged, offset, or split.
- **Stiffener Object:** Stiffener objects can be deleted, moved, mirrored, duplicated, aligned vertically, or aligned horizontally.
- **Node Object:** Node objects can be deleted, moved, mirrored, duplicated, aligned vertically, or aligned horizontally.

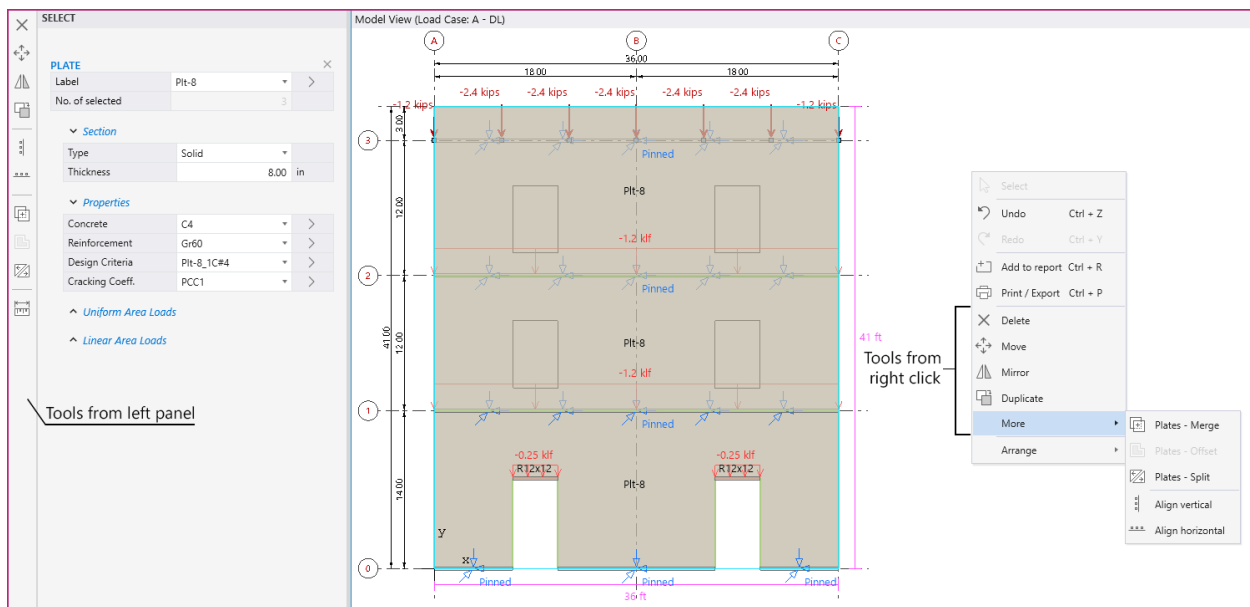

The **Left Panel** can also be utilized to edit an Object further:

- **Plate Object:** In addition to the editing tools provided in **Left Panel Toolbar**, the plate label, section type and thickness, plate properties, plate position and size, and area loads can be edited.
- **Stiffener Object:** In addition to the editing tools provided in **Left Panel Toolbar**, the stiffener label, section type and dimensions, stiffener properties, stiffener position and size, and line loads can be edited. Note that section dimensions and stiffener properties are not applicable to null stiffeners.
- **Node Object:** In addition to the editing tools provided in **Left Panel Toolbar**, the node location coordinates, point loads and eccentricities, and restraints can be edited.

When multiple different object types are selected, all applicable editing tools will be populated at the **Left Panel Toolbar**. Individual object types can be unselected by clicking the “x” button next to the Object Type at the **Left Panel** while other object remain selected

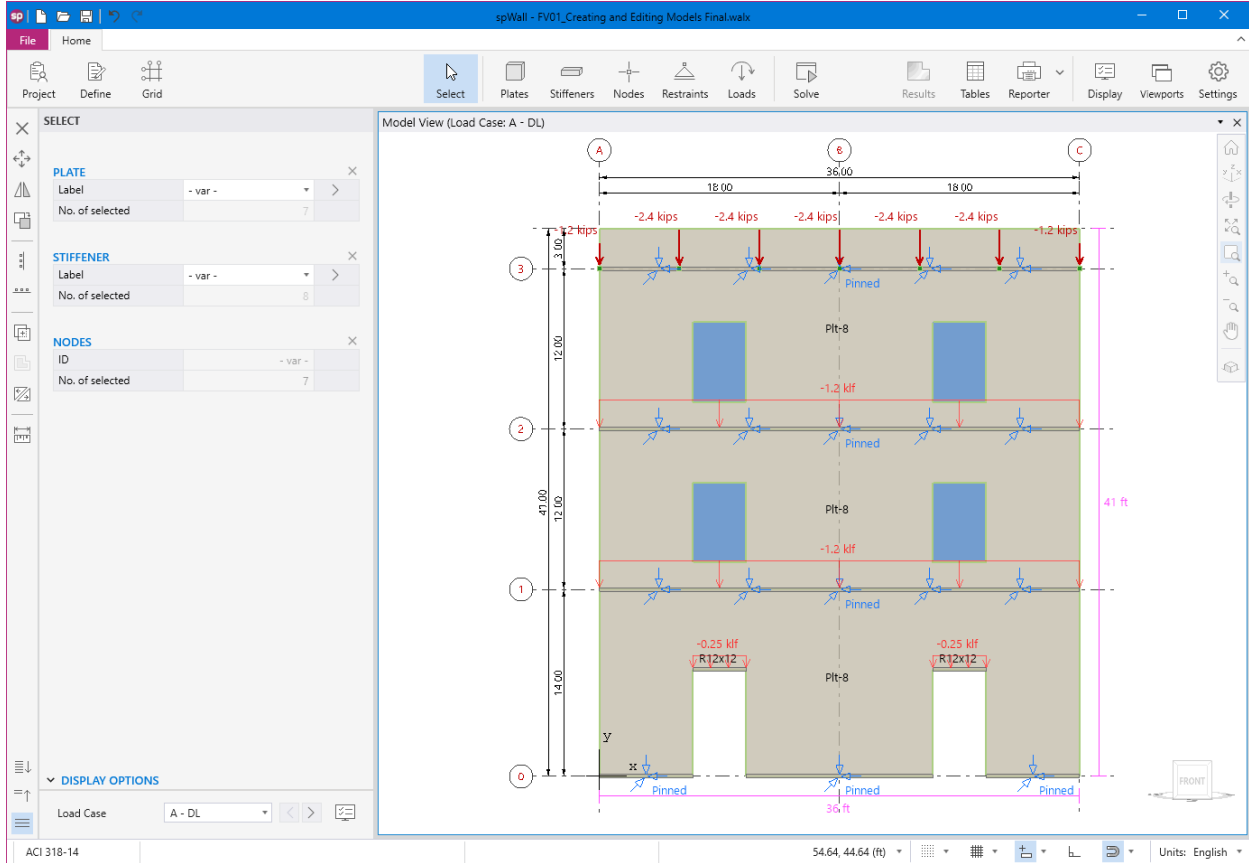

Press any white space in the **Viewport** in order to undo the selection.

CHAPTER

5

MODEL DEVELOPMENT

In spWall, models can be started by utilizing one of the four methods under **Projects** within **Start Screen**. These are namely; **Open Project**, **New Project**, **Templates**, and **Examples**. Each of these methods can be used to create a new model from scratch, edit a model developed previously for an earlier project, start with pre-defined template, or use an existing example file from the provided library. Each of the methods are described in detail in this chapter.

The screenshot shows the spWall software interface. The window title is "spWall - Untitled". The interface is divided into three main sections:

- Projects:** Contains options for "New project", "Open project", "Examples", and "Templates". Below "Templates" is a small icon representing a building structure.
- Recent:** Lists four recent projects with their full paths:
 - Tiltup Wall with Opening and Roof, Wind and Seismic Loads.walx**
C:\Program Files (x86)\StructurePoint\spWall\Examples
 - Tiltup Wall 4-Story Building.walx**
C:\Program Files (x86)\StructurePoint\spWall\Examples
 - Shear Wall with Openings.walx**
C:\Program Files (x86)\StructurePoint\spWall\Examples
 - Shear Wall 9-Story Building.walx**
C:\Program Files (x86)\StructurePoint\spWall\Examples
- Resources:** Contains links for "Manual...", "Design Examples...", "Tutorial Videos..." (with a play button icon), "spWall Info...", "Submit a Question...", "Check for Updates...", "Release Notes...", and "About spWall".

At the bottom right, there is a "Clear all history" button and copyright information: "spWall v10.00 (TM) Copyright © 1988-2022, STRUCTUREPOINT, LLC."

5.1. Opening Existing Models

In the **Start Screen** under **Projects** select the **Open Project** option and browse to the folder that contains an existing spWall input file. The input files created in spWall v5.01 (.wal) and in spWall v10 can be opened. The input files for the prior versions of the Program require to be saved in consecutively newer version until .wal file is obtained. Then, that wall file can be opened in v10. Input file created in the newer version of the spWall program cannot be opened by a previous version.

5.2. Creating New Models

In the **Start Screen** under **Projects** select the **New Project** option. The model development process may require general input regarding a specific project. Project Information is entered through the **Project** command button, and Structural Grids are entered through the **Grid** command button.

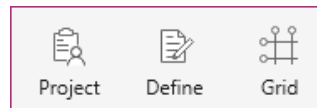

5.2.1. Project Information

The project information regarding to DESIGN CODE, UNIT SYSTEM, PROJECT NAME, PROJECT DESCRIPTION, PROJECT DATE, and PROJECT TIME can be entered into the model through the **Project Left Panel**. The Program supports American (ACI 318) and Canadian (CSA A23.3) Design Codes, and English and Metric unit systems.

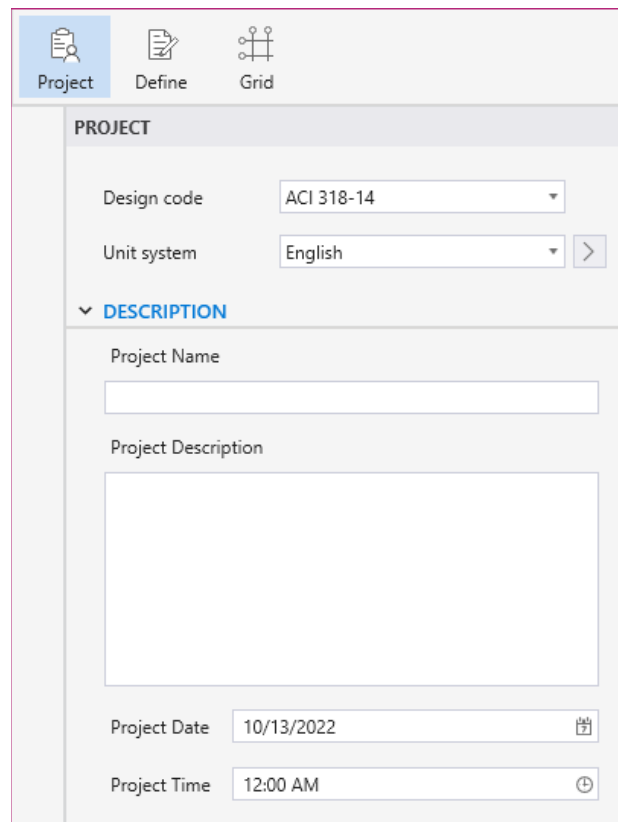

The screenshot shows the 'Project' tab selected in the left panel. The 'PROJECT' section contains the following fields:

- Design code:** A dropdown menu with 'ACI 318-14' selected.
- Unit system:** A dropdown menu with 'English' selected and a right-pointing arrow button.
- DESCRIPTION:** A section header with a downward arrow, followed by:
 - Project Name:** A text input field.
 - Project Description:** A large text area.
- Project Date:** A date input field with '10/13/2022' and a calendar icon.
- Project Time:** A time input field with '12:00 AM' and a clock icon.

5.2.2. Structural Grids

The structural grids can be created or imported in order to facilitate the input of structural elements (such as plates and stiffeners), openings, supports, and loads in a specific structural elevation view.

5.2.2.1. Working with Grids

You can select the **Grid** command button from the **Ribbon**. The corresponding **Grids Left Panel** provides various tools and options for effectively working with grids.

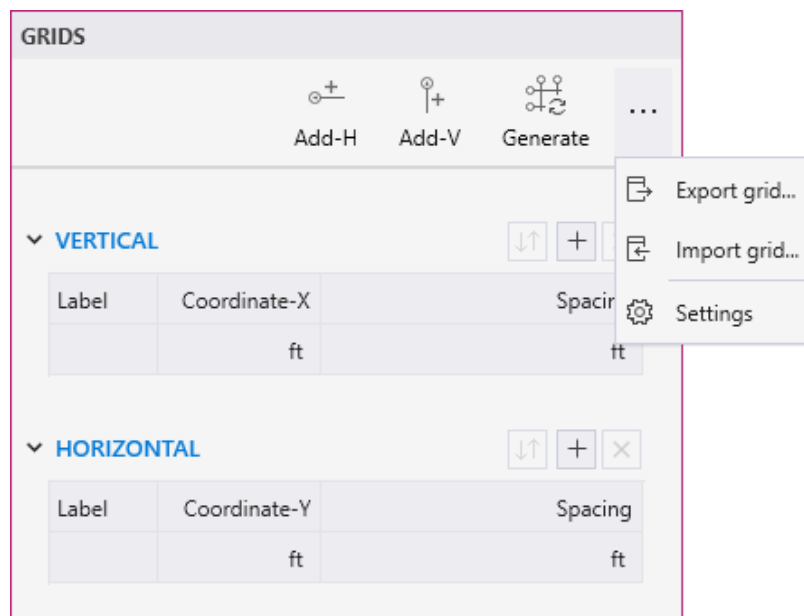

5.2.2.2. Generating Grids

- Click the **Generate** icon to display the GENERATE GRID LINES dialog box
- To create multiple grid lines at once enter:
number of grid spaces x grid interval in the GRID SPACING input box
- Entering a single number in the GRID SPACING input box will create a single grid line at the given spacing from either the start coordinates or the last existing grid line in that direction
- You can create grid lines at multiple intervals by separating the grid intervals by space

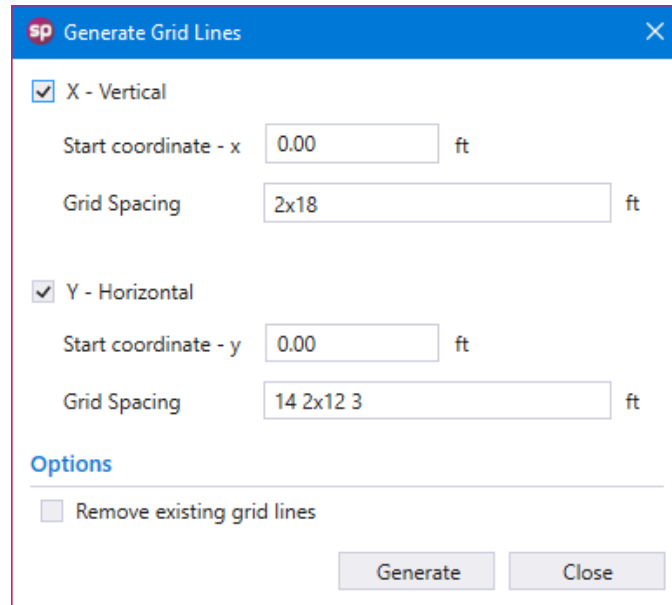

5.2.2.3. Adding Grids



Click the **Add-H** or **Add-V** commands to add a single HORIZONTAL or VERTICAL grid.

5.2.2.4. Using the Grid Table

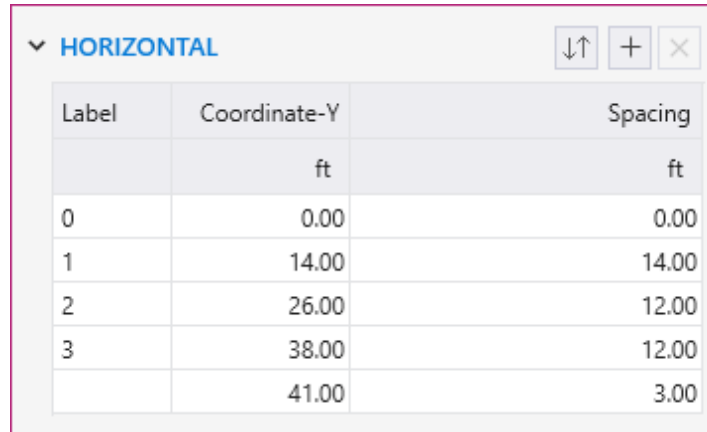
You can use the Grid table to change the LABEL, COORDINATE or SPACING of the grid. The table can also be used to add or delete specific grids.



Label	Coordinate-Y	Spacing
	ft	ft
0	0.00	0.00
1	14.00	14.00
2	26.00	12.00
3	38.00	12.00
	41.00	3.00

- Click on the  button to add a gridline in the active direction.
- Click on the  button to delete the selected gridline in the table.
- Click on the  button to reorder the labels if they have been shuffled.
- To change a grid LABEL, click on the desired grid in the table and click on its label. Leaving a grid label field empty will remove the label bubble from the gridline in the model.
- COORDINATE or SPACING of the grids can also be changed by clicking on the respective field and typing in the desired value.
- Changing the coordinate of the first gridline in the table displaces the entire grid system in the respective direction.
- Except the first gridline in the table, other gridlines cannot be assigned a negative spacing value.

5.2.2.5. Working with labels

You can use the **Settings / General / Grids** to change the ORDER & TYPE and LOCATION of the grid labels. You can also change how far the grid labels are located from the grid lines by changing the EDGE EXTENSION value.

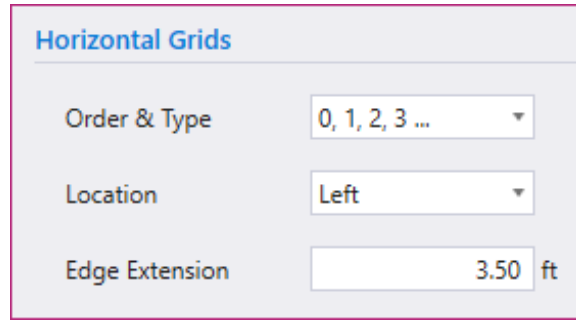

5.2.2.6. Grid Display Options

- Use the checkboxes to toggle the display of various grid items in the model.
- You can use the slider to adjust the SIZE of the grid LABELS, UNITS and DIMENSIONS displayed.

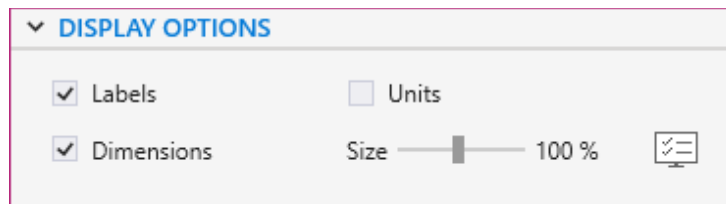

5.2.3. Generating Definitions

Once the project information has been completed, editing and adding new definitions can be done in the DEFINITIONS Dialog Box by selecting the **Define** command button from the **Ribbon**.

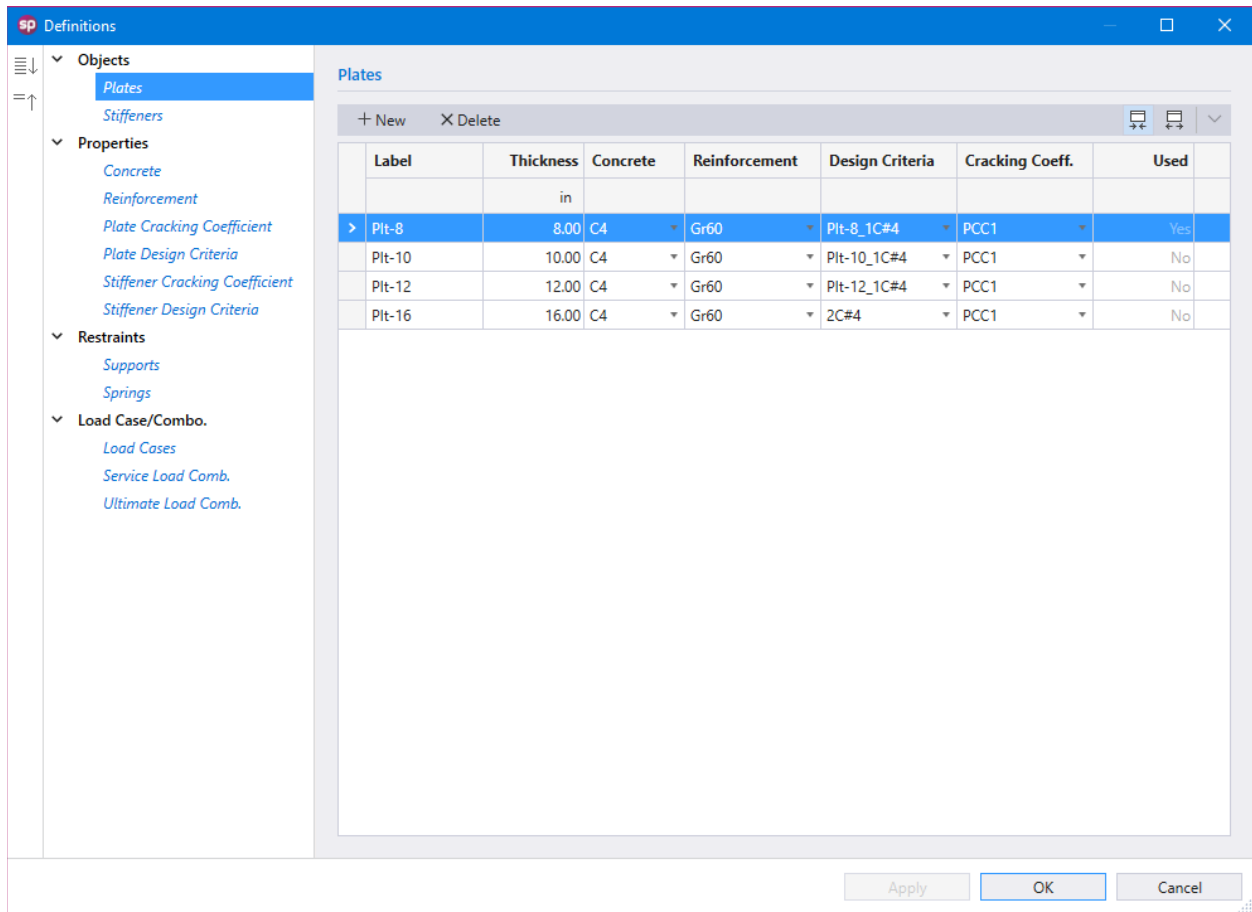

The DEFINITIONS dialog box contains predefined labels for various **Objects**, **Properties**, **Restraints**, and **Load Case/Combo**. You can enter additional definitions per your project requirements by clicking the NEW button. Similarly, an existing definition can be removed by clicking the DELETE button. Either start by creating definitions to be used in the program in the DEFINITIONS dialog box or simply start creating the model with one of the several command buttons available in the **Ribbon** using the default program definitions.

Items like PROPERTIES, RESTRAINTS and LOAD CASES/COMBO are available during modeling only after they have been first defined in the DEFINITIONS dialog box. Objects i.e. plates and stiffeners can also be defined in the DEFINITIONS dialog box to be used during modeling. Conversely, Object definitions are automatically added to the list of definitions as they are created and used during modeling process.

Clicking the dialog launcher  next to an item in the **Left Panel** will open the DEFINITIONS dialog box.

5.2.3.1. Objects

The **Objects** that can be defined are: **Plates** and **Stiffeners**.

Plates

The **Plates** Object definition consists of the LABEL, THICKNESS, PROPERTIES, and whether the **Plates** label is USED in the model or not.

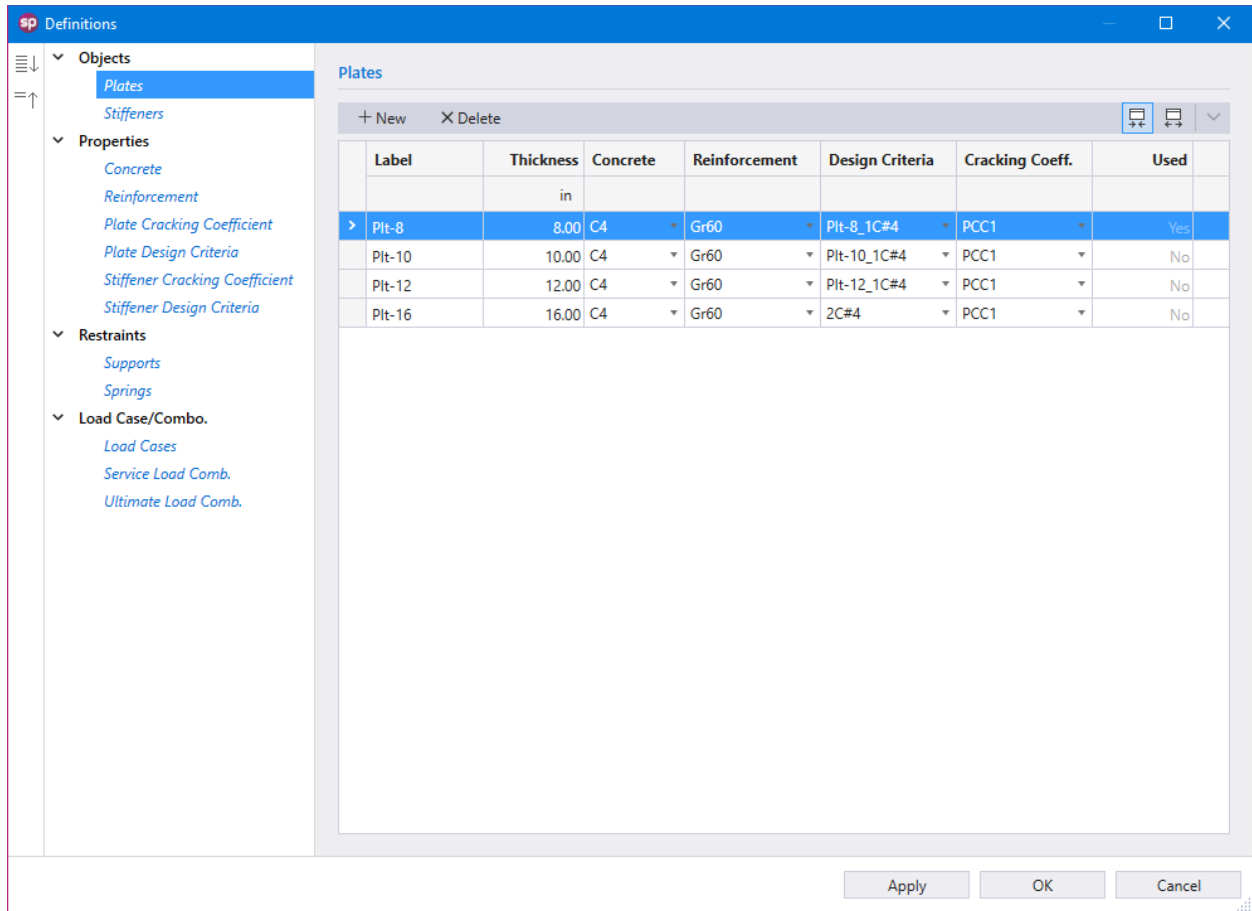

Stiffeners

The **Stiffeners** Object definition consists of the LABEL, PROPERTIES, SECTION, FLANGE, and whether the **Stiffeners** label is USED in the model or not.

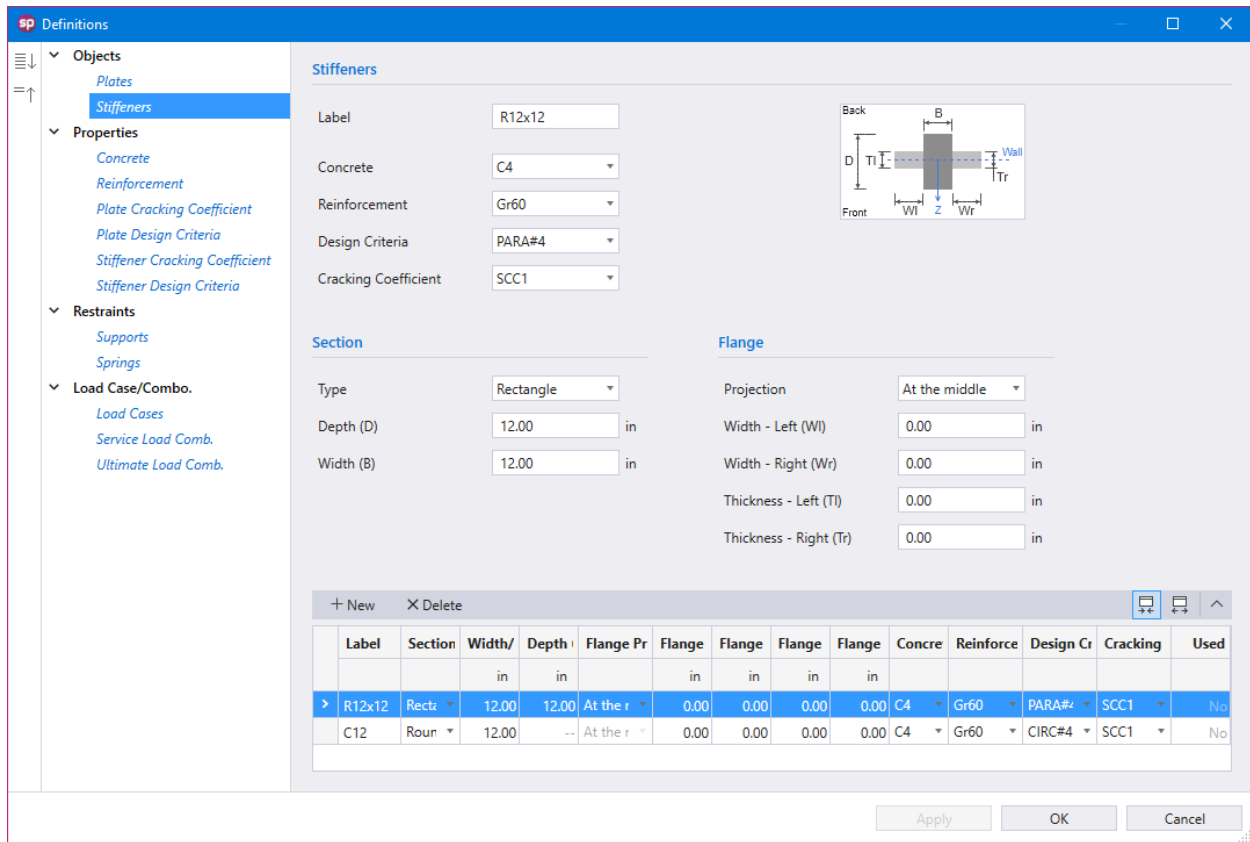

For rectangular section, WIDTH (B) is measured in the direction of the wall plane while DEPTH (D) is measured normal to the wall plane.

The flange PROJECTION determines the position of the flange along the depth of the section. For rectangular sections, there are 3 choices: to the left, to the right and at the middle. For circular sections, at the middle is the only option.

The flange dimensions are used to calculate section stiffness during the finite element analysis as well as for flexural design.

5.2.3.2. Properties

The **Properties** that can be defined are: **Concrete**, **Reinforcement**, **Plate Cracking Coefficient**, **Plate Design Criteria**, **Stiffener Cracking Coefficient**, and **Stiffener Design Criteria**.

Concrete

The **Concrete** definition consists of the LABEL, COMPRESSIVE STRENGTH, UNIT WEIGHT, YOUNG'S MODULUS, POISSON'S RATIO, PRECAST, and whether the **Concrete** label is USED in the model or not.

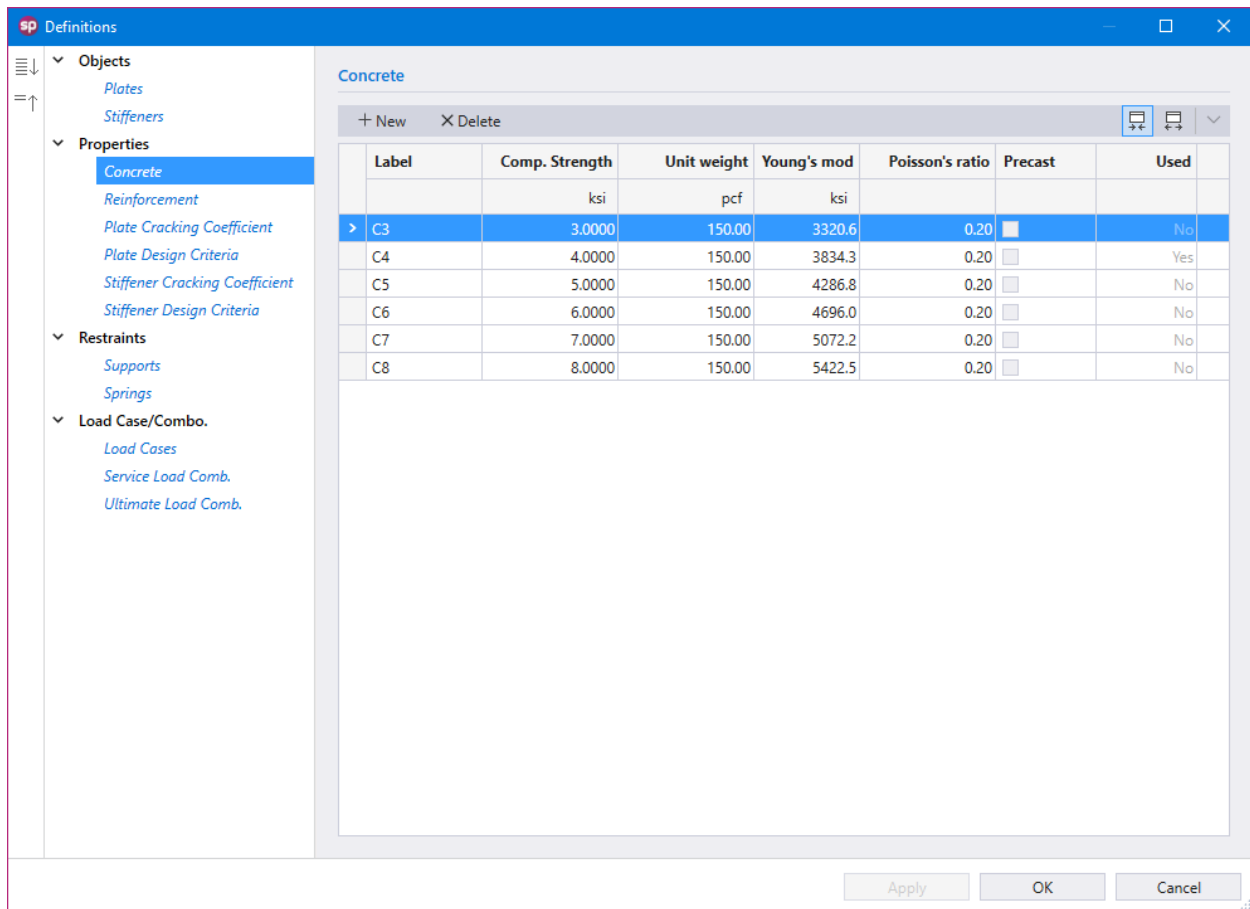

The YOUNG'S MODULUS is calculated automatically and will display a result that is based on the equations in the selected Code. Note that the value of YOUNG'S MODULUS can be modified if it differs from the calculated value.

Check PRECAST checkbox if precast concrete is used. Lower value of minimum reinforcement ratio is allowed for precast concrete than for cast-in-place concrete in all supported design codes. Also, a higher value of resistance factor for concrete, ϕ_c , is assumed in CSA A23.3-14/04 standard.

Reinforcement

The **Reinforcement** definition consists of the LABEL, YIELD STRENGTH, YOUNG’S MODULUS, and whether the **Reinforcement** label is USED in the model or not.

The screenshot shows the 'Definitions' dialog box with the 'Reinforcement' section selected. The table contains the following data:

Label	Yield strength	Young's modulus	Used
	ksi	ksi	
> Gr40	40.0000	29000.0	No
Gr50	50.0000	29000.0	No
Gr60	60.0000	29000.0	Yes
Gr75	75.0000	29000.0	No

Buttons at the bottom: Apply, OK, Cancel

Plate Cracking Coefficient

The **Plate Cracking Coefficient** definition consists of the LABEL, IN-PLANE and OUT-OF-PLANE PLATE CRACKING COEFFICIENTS for SERVICE and ULTIMATE COMBINATIONS, and whether the **Plate Cracking Coefficient** label is USED in the model or not.

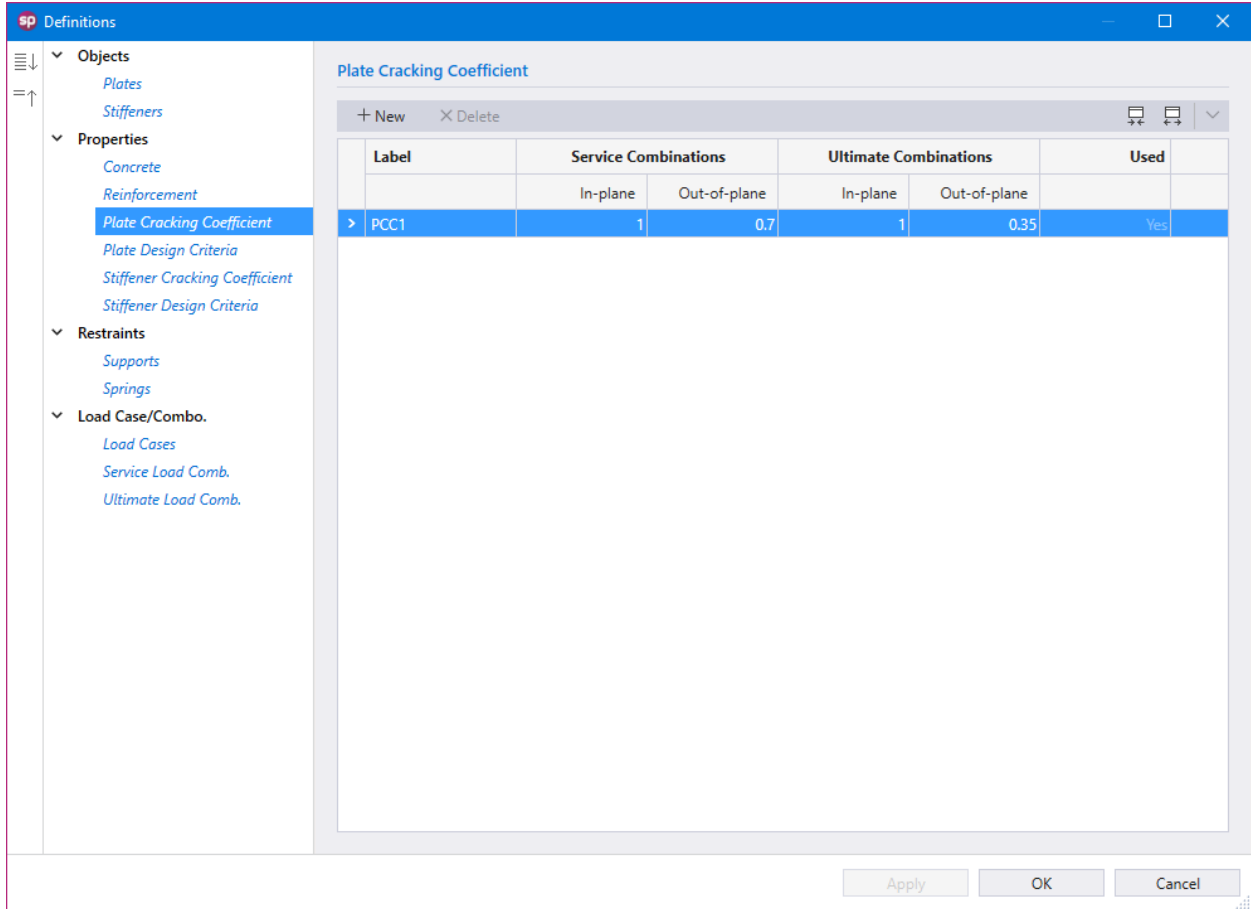

Cracking coefficients reduce the plate element stiffness used in the finite element analysis to account for the concrete section cracking.

Plate Design Criteria

The **Plate Design Criteria** definition consists of the LABEL, REINFORCEMENT LAYOUT (Refer to [Section 2.5.1](#) for more information), REINFORCEMENT RATIO, REINFORCEMENT LOCATION, and whether the **Plate Design Criteria** label is USED in the model or not.

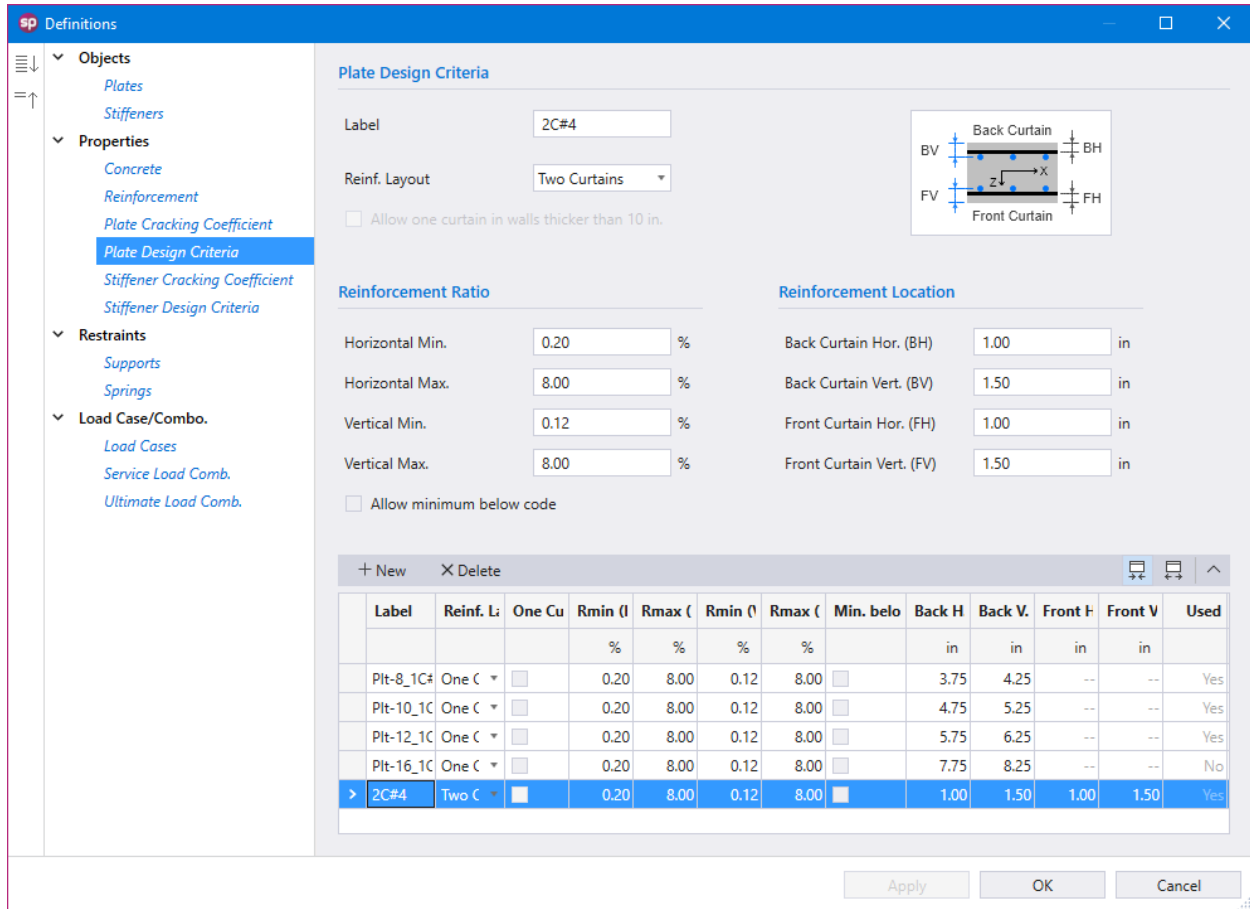

If ONE CURTAIN reinforcement layout is selected for walls thicker than 10 in. [250mm] and you want the program to suppress warning that one layer should not be used in thick walls, select the ALLOW ONE CURTAIN IN WALLS THICKER THAN 10 IN. option. If the TWO CURTAINS option is selected, the calculated total area of reinforcement is assumed to be equally distributed between each curtain, i.e. each curtain receives half of the total area reported by the program in the results.

If ONE CURTAIN reinforcement layout is selected, the REINFORCEMENT LOCATION is measured from the left side of the wall to the centroid of the bar (BACK CURTAIN). If the TWO CURTAINS option is selected, the location of each curtain is allowed to be entered individually.

If the minimum reinforcement ratio entered is below the code specified value, the program will use the code minimum unless the ALLOW MINIMUM BELOW CODE option is checked.

Stiffener Cracking Coefficient

The **Stiffener Cracking Coefficient** definition consists of the LABEL, AREA, INERTIA (I_y), INERTIA (I_z), TORSION (J), and whether the **Stiffener Cracking Coefficient** label is USED in the model or not.

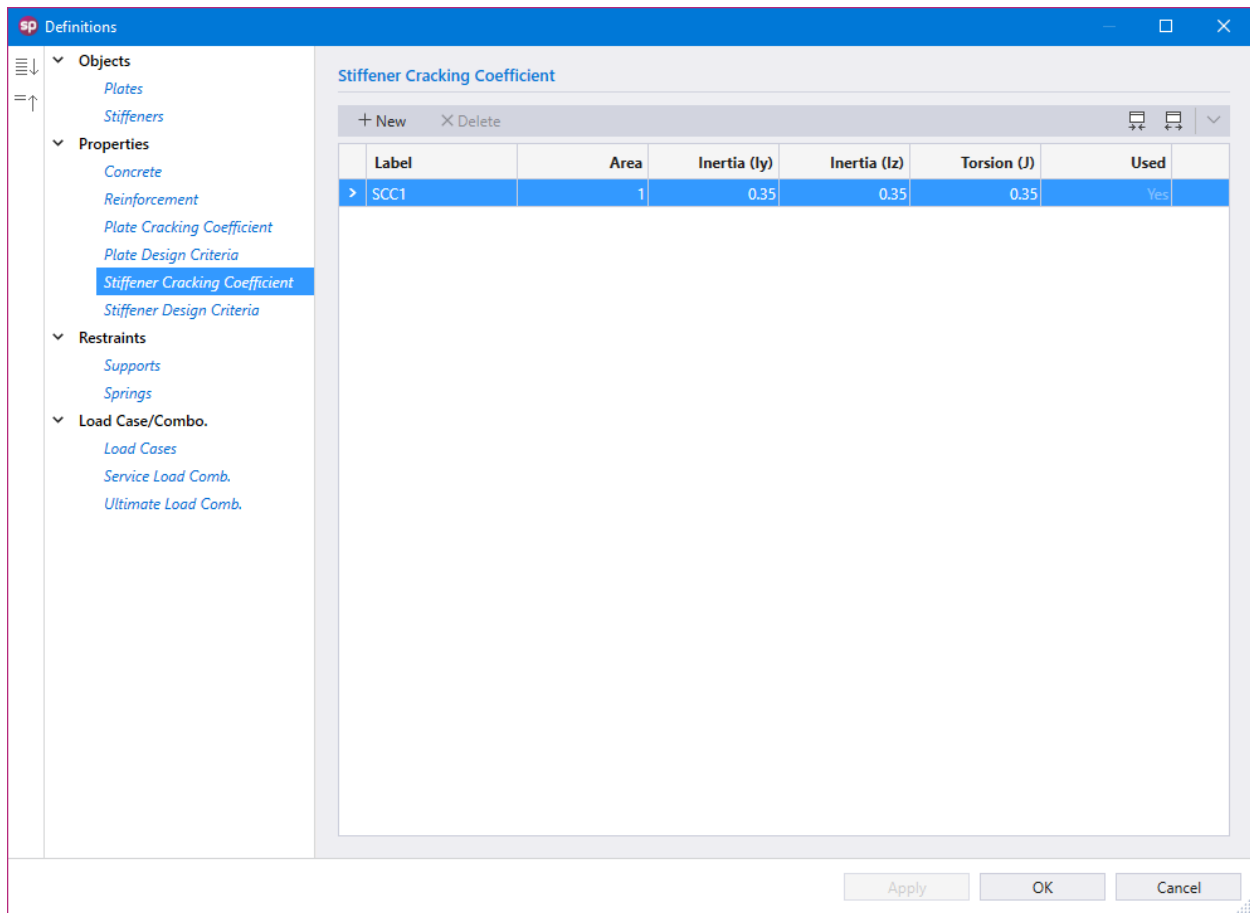

Cracking coefficients reduce the stiffener element stiffness used in the finite element analysis to account for the concrete section cracking.

Stiffener Design Criteria

The **Stiffener Design Criteria** definition consists of the LABEL, REINFORCEMENT LAYOUT, COVER TO LONGITUDINAL BAR CENTER, COVER TO TRANSVERSE BAR CENTER, LONGITUDINAL REINFORCEMENT RATIO, and whether the **Stiffener Design Criteria** label is USED in the model or not.

Stiffener Design Criteria

Label:

Reinf. Layout:

Cover to Longitudinal Bar Center

Left / Right: in

Front / Back: in

Longitudinal Reinforcement Ratio

Minimum: %

Maximum: %

Cover to Transverse Bar Center

Left / Right: in

Front / Back: in

Label	Reinf. Layout	Left / Right	Front / Back	Left / Right	Front / Back	Min. Ratio	Max. Ratio	Used
		in	in	in	in	%	%	
> PARA#4	Parallel to wall	2.25	2.25	1.75	1.75	0.33	8.00	Yes
NORM#4	Normal to wall	2.25	2.25	1.75	1.75	0.33	8.00	No
RECT#4	Rectangular	2.25	2.25	1.75	1.75	0.33	8.00	No
CIRC#4	Circular	2.25	--	1.75	--	0.33	8.00	Yes

Buttons: Apply, OK, Cancel

The REINF. LAYOUT The various options are illustrated below:

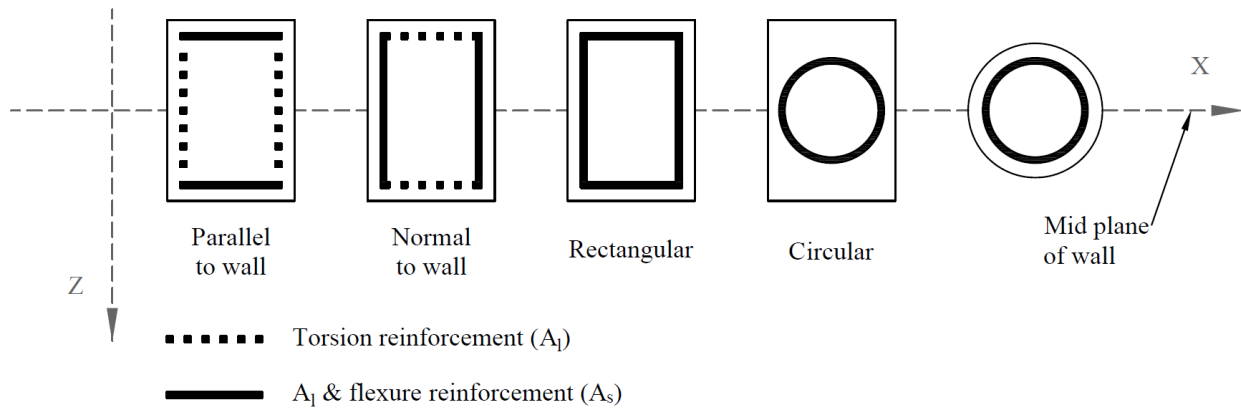

The above-mentioned options are for the part for longitudinal reinforcement that resists flexure and axial loads. The part of longitudinal reinforcement that resists torsion is either rectangular or circular depending on the selected layout.

Also, it should be mentioned that for stiffer elements that have circular sections, circular layout is the only option that can be applied to those elements.

The cover to longitudinal and transverse reinforcements is measured from the section side to the centroid of bar.

The minimum and maximum ratios for longitudinal reinforcement are used to check flexural design only. When torsional longitudinal reinforcement is required the total ratio of steel may exceed the maximum value specified here.

5.2.3.3. Restraints

The **Restraints** that can be defined are: **Supports** and **Springs**.

Supports

The **Supports** definition consists of the LABEL, TRANSLATIONAL and ROTATIONAL DEGREES OF FREEDOM along with their status of restraint (restrained or free), and whether the **Supports** label is USED in the model or not. Refer to [Section 2.3.2](#) for more information.

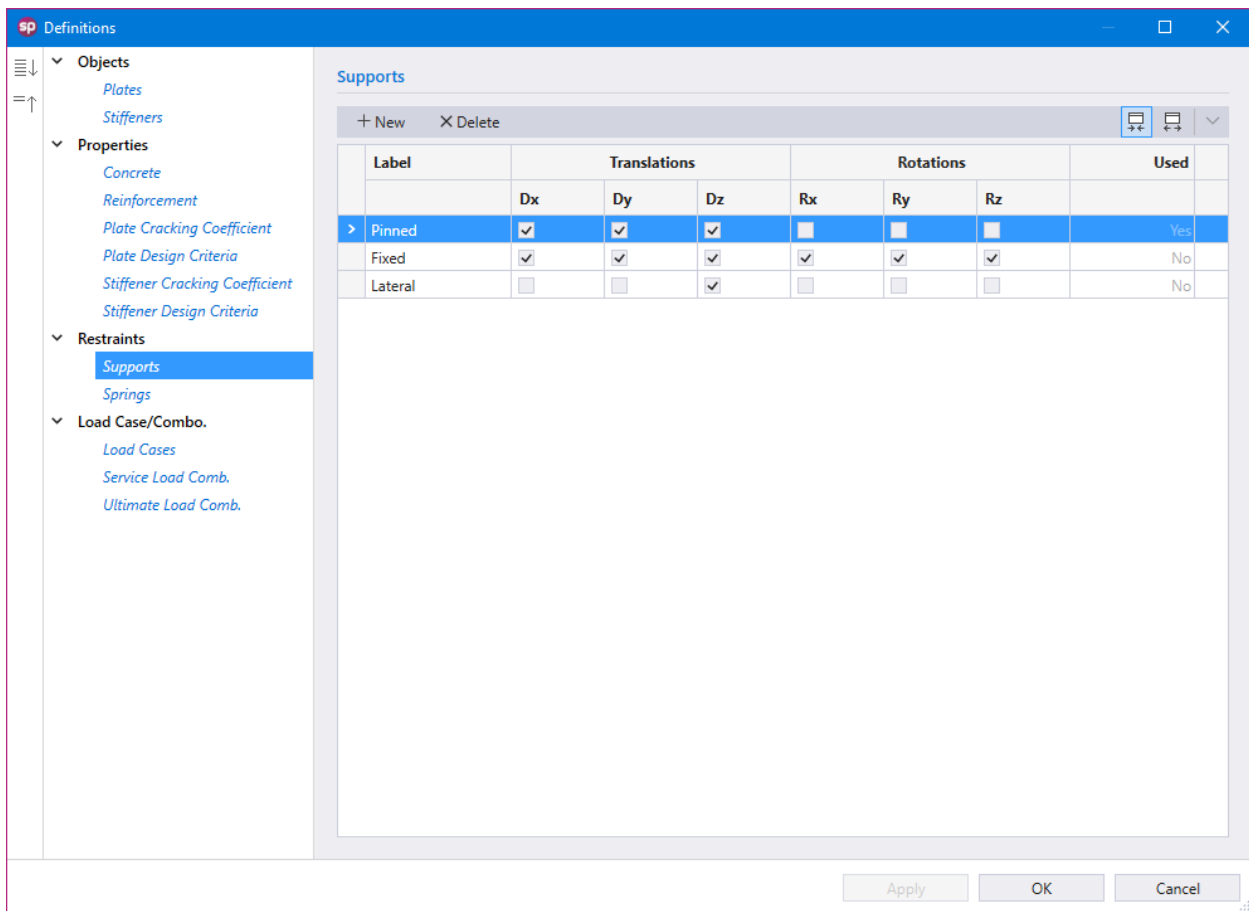

Springs

The **Springs** definition consists of the LABEL, SPRING CONSTANTS for TRANSLATIONAL and ROTATIONAL DEGREES OF FREEDOM, and whether the **Springs** label is USED in the model or not.

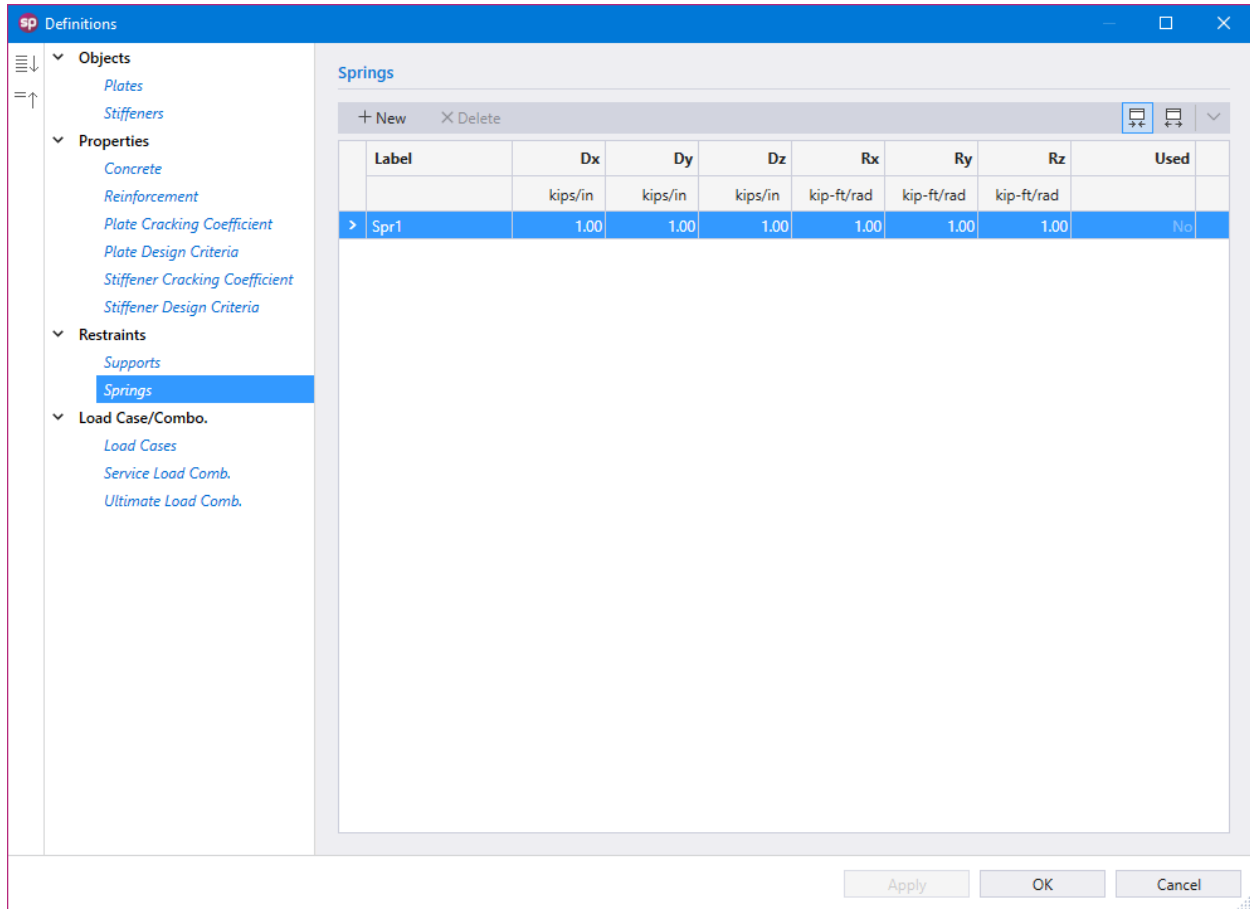

5.2.3.4. Load Case / Combo.

The **Load Case / Combo.** that can be defined are: **Load Cases**, **Service Load Combinations**, and **Ultimate Load Combinations**.

Load Cases

The **Load Cases** definition consists of the CASE, TYPE, LABEL, whether the SELF-WEIGHT be included with the load case or not, and whether the **Load Cases** is USED in the model or not.

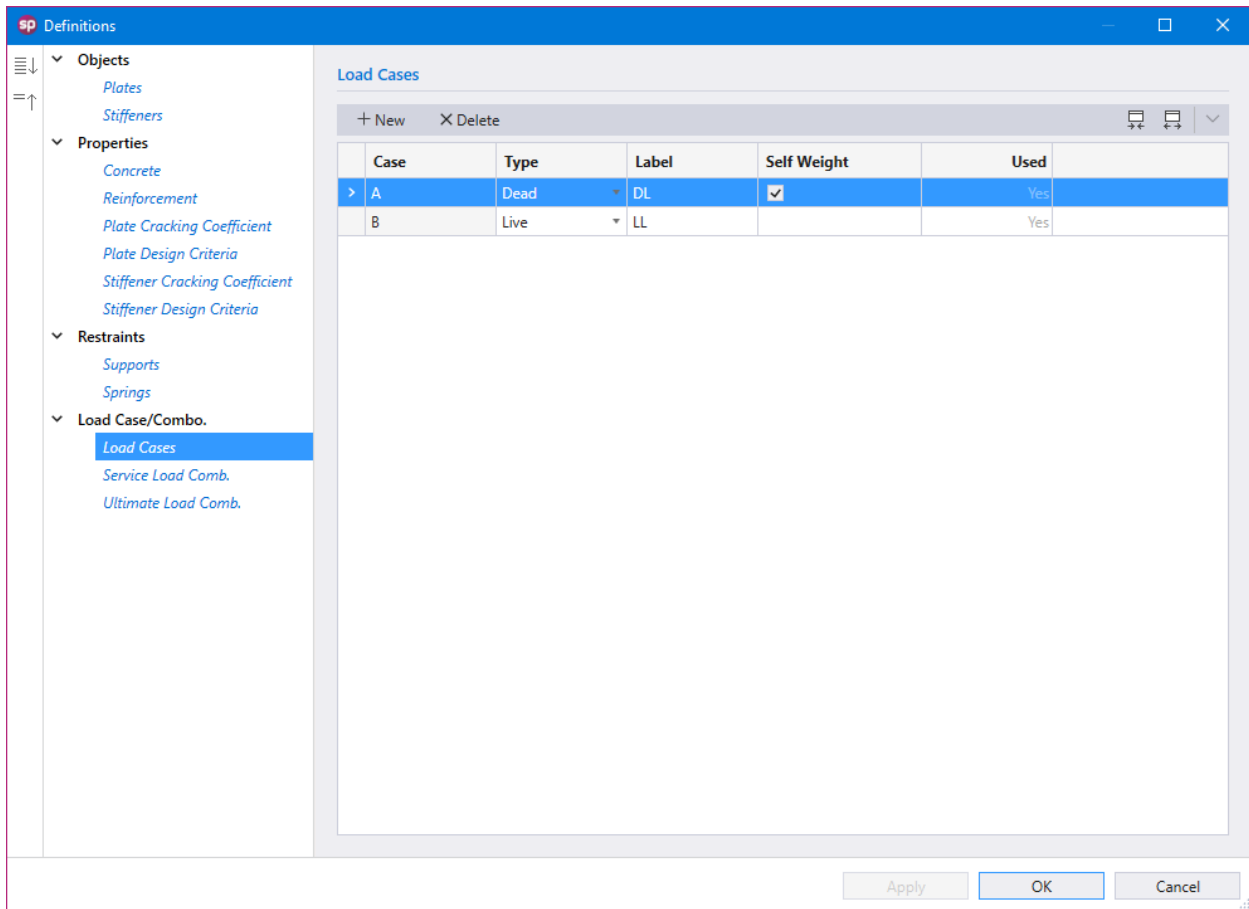

Service Load Combinations

The **Service Load Combinations** definition consists of the LOAD CASES, LOAD CASE TYPE, LOAD COMBINATION NUMBER, LOAD COMBINATION LABEL, and LOAD FACTORS. Load combinations can also be generated automatically based on the design code in the model.

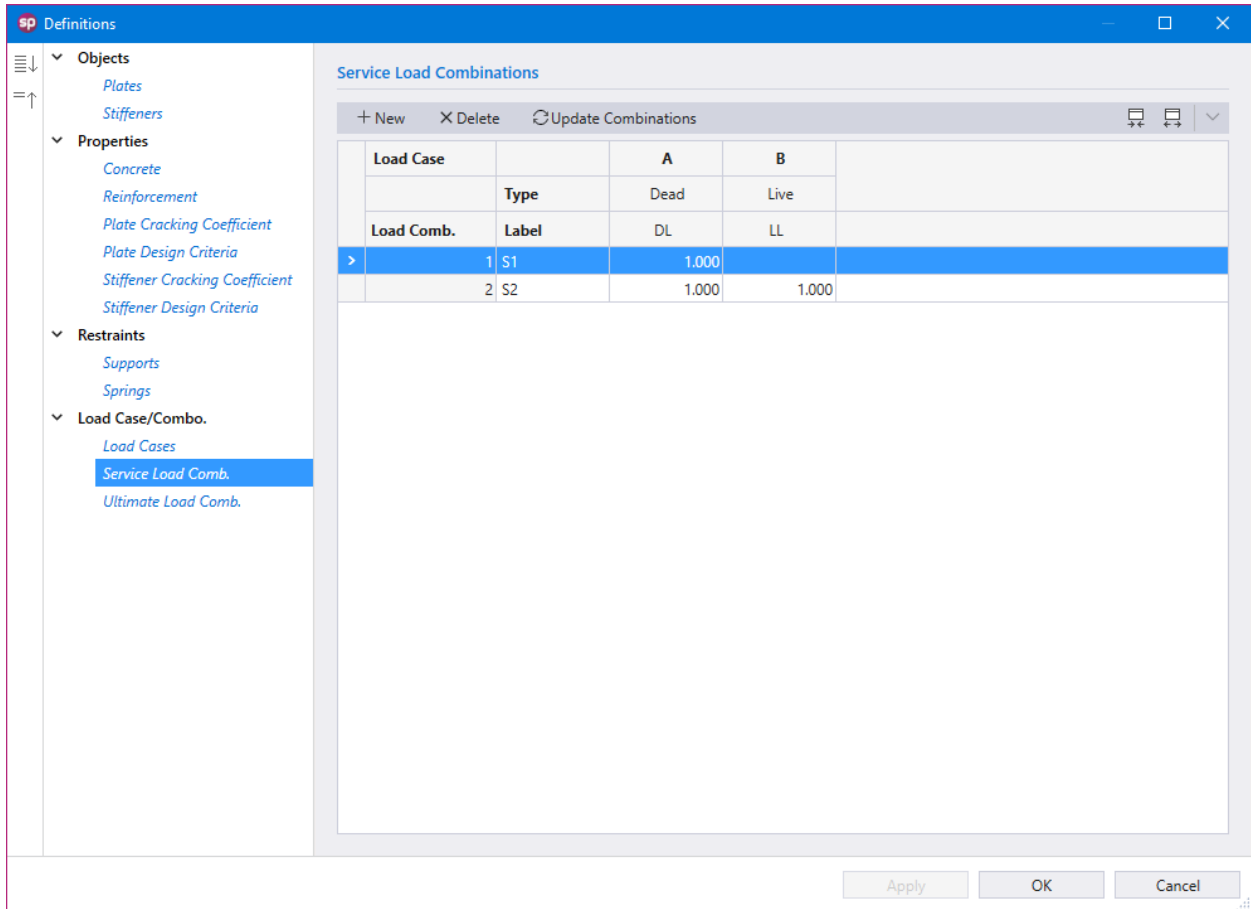

Ultimate Load Combinations

The **Ultimate Load Combinations** definition consists of the LOAD CASES, LOAD CASE TYPE, LOAD COMBINATION NUMBER, LOAD COMBINATION LABEL, and LOAD FACTORS. Load combinations can also be generated automatically based on the design code in the model.

The screenshot shows the 'Definitions' window with the 'Ultimate Load Combinations' tab selected. The left sidebar contains a tree view with the following categories:

- Objects
 - Plates
 - Stiffeners
- Properties
 - Concrete
 - Reinforcement
 - Plate Cracking Coefficient
 - Plate Design Criteria
 - Stiffener Cracking Coefficient
 - Stiffener Design Criteria
- Restraints
 - Supports
 - Springs
- Load Case/Combo.
 - Load Cases
 - Service Load Comb.
 - Ultimate Load Comb.**

The main area displays a table titled 'Ultimate Load Combinations' with the following data:

Load Case		A	B	
	Type	Dead	Live	
Load Comb.	Label	DL	LL	
1	U1	1.400		
2	U2	1.200	1.600	

At the bottom of the window, there are three buttons: 'Apply', 'OK', and 'Cancel'.

5.2.4. Creating Model Objects

The Objects that can be created are: **Plates** and **Stiffeners**.

5.2.4.1. Plates

You can create **Plates** using the **Plates** command from the **Ribbon**.

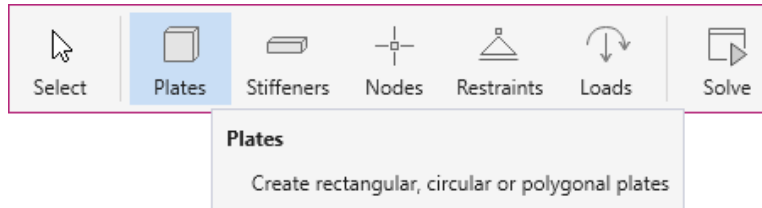

You can draw **Rectangular**, **Circular** or **Polygonal** plates by using one of the following three tools in the **Plates Left Panel**.

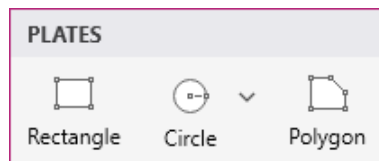

If you have already defined a plate type in the DEFINITIONS dialog, select it from the LABEL drop down menu in the **Left Panel** before you start drawing. You can also simply select the SECTION and PROPERTIES and start drawing, the corresponding definition created will automatically be added to the DEFINITIONS dialog.

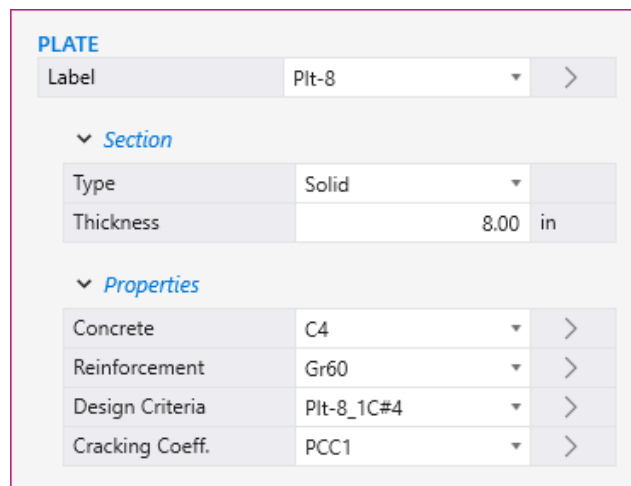

To draw a plate shape using the mouse, first select the desired tool.

- Then click on the workspace to begin drawing.
- For circular or rectangular plates, move your mouse until the desired size is achieved and click again to finish drawing.
- For polygonal plates keep clicking on the workspace until you create all the desired vertices. You can close a polygon either by clicking the right mouse button or manually clicking on the first vertex point created.

Alternately plate shapes can also be created by using the dynamic input box.

- To display a dynamic input box, press ENTER after you have selected the desired plate tool.

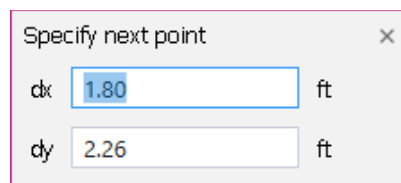

Specify next point

dx: 1.80 ft

dy: 2.26 ft

- You will be required to provide the start point (center point for circular plates).
- Type in the required coordinates and press ENTER.
- Press ENTER once more to display the dynamic input box again. Type in the required quantities i.e. width and height for a rectangular plate or radius for a circular plate and press ENTER to finish drawing.
- For polygonal plates you will have to keep pressing ENTER to bring out the dynamic input box to provide each vertex. The polygon will be closed once you enter the coordinates of the starting point provided that the shape is geometrically correct.

5.2.4.2. Stiffeners

You can create **Stiffeners** using the **Stiffeners** command from the **Ribbon**.

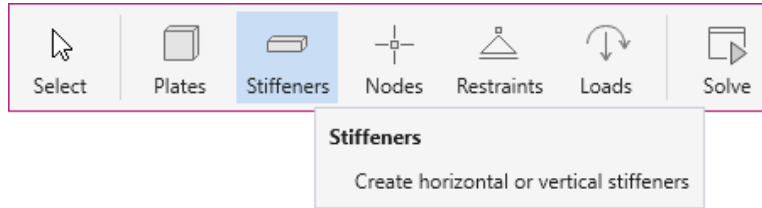

You can draw **Null**, and **Solid** stiffeners by using one of the following two tools in the **Stiffeners Left Panel**.

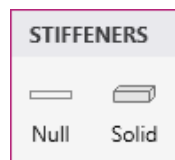

Null stiffeners are stiffeners without any properties. They only act as place holders for linear loads and supports, and do not contribute to the model structurally.

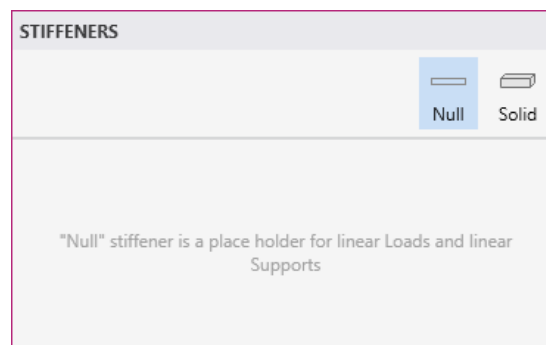

If you have already defined a **Solid** stiffener type in the DEFINITIONS dialog, simply select it from the LABEL drop down menu in the **Left Panel** before you start drawing. You can also simply select the SECTION and PROPERTIES and start drawing, the corresponding definition created will automatically be added to the DEFINITIONS dialog.

STIFFENERS

Null Solid

STIFFENER

Label: R12x12 >

▼ Section

Type	Rectangular	>
Depth (D)	12.00 in	
Width (B)	12.00 in	
Flange Projection	At the middle	>
Flange (WI)	0.00 in	
Flange (Wr)	0.00 in	
Flange (TI)	0.00 in	
Flange (Tr)	0.00 in	

▼ Properties

Concrete	C4	>
Reinforcement	Gr60	>
Design Criteria	PARA#4	>
Cracking Coeff.	SCC1	>

To draw a stiffener using the mouse, first select the desired tool.

- Then click on the workspace to begin drawing.
- Move your mouse until the desired length is achieved and click again to finish drawing.

Alternately stiffeners can also be created by using the dynamic input box.

- To display a dynamic input box, press ENTER after you have selected the desired stiffener tool.

Specify start point ✕

X ft

Y ft

- You will be required to provide the start point.
- Type in the required coordinates and press ENTER.
- Press ENTER once more to display the dynamic input box again. Type in the required length and press ENTER to finish drawing.

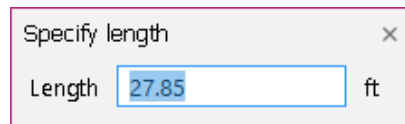

Specify length ×

Length ft

5.2.4.3. Restraints

The **Restraints** that can be assigned are: **Nodal Supports**, **Nodal Springs**, and **Linear Supports**. You can create **Restraints** using the **Restraints** command from the **Ribbon**.

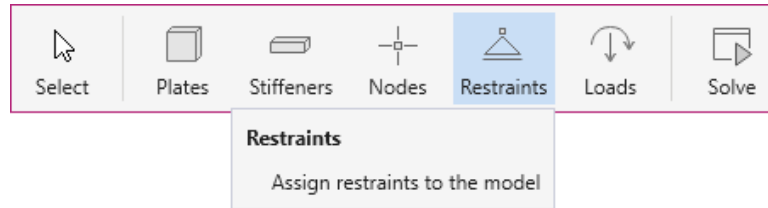

spWall considers nodal restraints (nodal supports and nodal springs) as nodal properties. It is possible to assign more than one kind of restraint to a node at the same time. Linear restraints can only be assigned to stiffeners. Linear restraints can be used to restrain a line representing a continuous support such as a floor or roof structural diaphragm. The spWall solver will mesh the linear restraint and apply it to all the nodes contained along the extent of the restrained stiffener.

- If you have already defined a restraint in the DEFINITIONS dialog, simply select it from the LABEL drop down menu in the **Left Panel** to assign it to the model. You can also simply select the DEGREES OF FREEDOM for supports (or enter the SPRING CONSTANT values for the desired DEGREES OF FREEDOM for springs) and start assigning, the corresponding restraint definition created will automatically be added to the DEFINITION dialog.
- You can also use the CLEAR RESTRAINTS button to clear any existing restraints and select new ones.
- Next, click on the location you want the restraint to be assigned to. Note that linear supports can only be assigned to stiffeners.
- You can also marquee select a group of nodes or stiffeners to assign all of them the same restraints.

RESTRAINTS

Linear Nodal

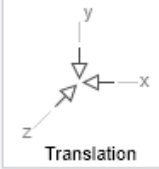
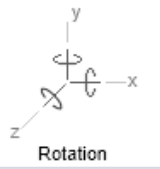
Translation Rotation

▼ *Support*

Label: - none - >

Dx	Dy	Dz	Rx	Ry	Rz
<input type="checkbox"/>	<input type="checkbox"/>	<input type="checkbox"/>	<input type="checkbox"/>	<input type="checkbox"/>	<input type="checkbox"/>

RESTRAINTS

Linear Nodal

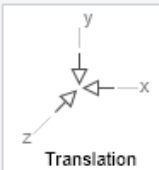
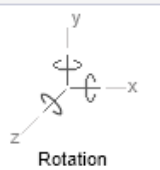
Translation Rotation

▼ *Support*

Label: - none - >

Dx	Dy	Dz	Rx	Ry	Rz
<input type="checkbox"/>	<input type="checkbox"/>	<input type="checkbox"/>	<input type="checkbox"/>	<input type="checkbox"/>	<input type="checkbox"/>

▼ *Spring*

Label: - none - >

Dx	Dy	Dz	Rx	Ry	Rz
kips/in			kip-ft/rad		
0.00	0.00	0.00	0.00	0.00	0.00

5.2.4.4. Loads

You can create **Loads** using the **Loads** command from the **Ribbon**.

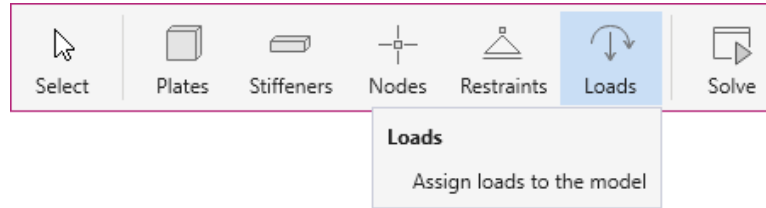

You can assign **Point** loads, **Uniform Line** loads, **Uniform Area** loads, or **Linear Area** loads by using one of the four options that are presented in the **Loads Left Panel**.

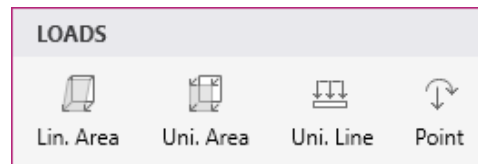

Assigning Linear Area Loads

Linear Area loads can only be assigned to **Plates**.

LOADS

Lin. Area
 Uni. Area
 Uni. Line
 Point

▼ Linear Area Loads

Load Case: A - DL
<
>

	Y	W _x	W _y	W _z
	ft	psf	psf	psf
Top	10.00	0.0000	0.0000	100.0000
Bottom	0.00	0.0000	0.0000	5.0000

Clear loads

▼ OPTIONS

Replace existing load
 Add to existing load

To assign a **Linear Area** load, make sure that the **Lin. Area** command in the **Left Panel** is selected. The **Left Panel** should be displaying various **Linear Area Loads** options.

- Select the **LOAD CASE** you want the **Linear Area** load to belong to. You can always define **LOAD CASES** in the **DEFINITIONS** dialog.
- In the top and bottom **Y**, **W_x**, **W_y**, and **W_z** boxes, type in the required location and load values. Note that the thumbnail in the **Left Panel** show the sign convention for the forces.
- From the **OPTIONS** select if you want to **ADD TO EXISTING LOAD** on the plate or **REPLACE EXISTING LOAD** completely.
- Next, click on the plate you want the load to be assigned to. You can also marquee select a group of plates to assign all of them the same linear area load.

Assigning Uniform Area Loads

Uniform Area loads can only be assigned to **Plates**.

LOADS

Lin. Area **Uni. Area** Uni. Line Point

Y Wx Wy Wz X Z

▼ **Loads**

Load Case A - DL < >

Wx	0.0000	psf
Wy	0.0000	psf
Wz	0.0000	psf

Clear loads

▼ **OPTIONS**

Replace existing load
 Add to existing load

To assign a **Uniform Area** load, make sure that the **Uni. Area** command in the **Left Panel** is selected. The **Left Panel** should be displaying various **Uniform Area** loads options.

- Select the **LOAD CASE** you want the **Uniform Area** load to belong to. You can always define **LOAD CASES** in the **DEFINITIONS** dialog.
- In the W_x , W_y , and W_z boxes, type in the required load value. Note that the thumbnail in the **Left Panel** show the sign convention for the forces.
- From the **OPTIONS** select if you want to **ADD TO EXISTING LOAD** on the plate or **REPLACE EXISTING LOAD** completely.
- Next, click on the plate you want the load to be assigned to. You can also marquee select a group of plates to assign all of them the same area load.

Assigning Uniform Line Loads

Uniform Line loads can only be assigned to **Stiffeners**.

LOADS

Lin. Area

Uni. Area

Uni. Line

Point

▼ **Loads**

Load Case: A - DL

W _x	0.000	klf
W _y	0.000	klf
W _z	0.000	klf
Eccentricity (E _z)	0.00	in

▼ **OPTIONS**

Replace existing load

Add to existing load

To assign a **Uniform Line** load, make sure that the **Uni. Line** command in the **Left Panel** is selected. The **Left Panel** should be displaying various **Uniform Line** load options.

- Select the **LOAD** case you want the **Uniform Line** load to belong to. You can always define **LOAD CASES** in the **DEFINITIONS** dialog.
- In the **W_x**, **W_y**, **W_z**, and **E_z** boxes, type in the required load and eccentricity values. Note that the thumbnail in the **Left Panel** show the sign convention for the forces and eccentricity. The eccentricity can be positive or negative based on the location of the point load to control how the additional created moments are applied to the model.
- From the **OPTIONS** select if you want to **ADD TO EXISTING LOAD** on the node or **REPLACE EXISTING LOAD** completely.

- Next, click on the stiffener you want the load to be assigned to. You can also marquee select a group of stiffeners to assign all of them the same uniform line load.

Assigning Point Loads

spWall considers **Point** loads as nodal properties. As such, **Point** loads can only be assigned to a **Node**.

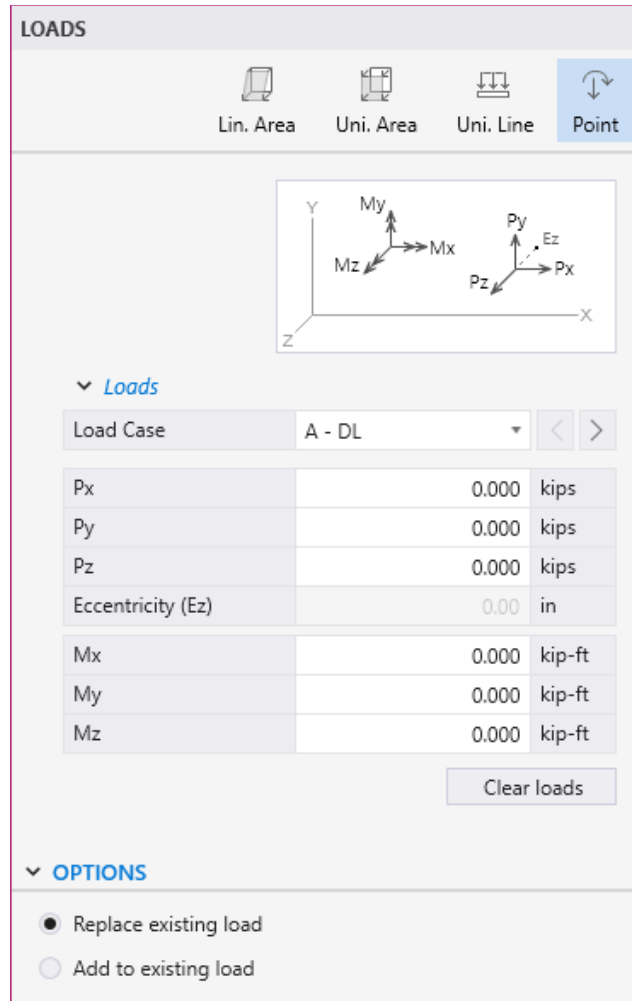

To assign a **Point** load, make sure that the **Point** command in the **Left Panel** is selected. The **Left Panel** should be displaying various **Point Loads** options.

- Select the **LOAD** case you want the **Point** load to belong to. You can always define **LOAD CASES** in the **DEFINITIONS** dialog.

- In the P_x , P_y , P_z , E_z , M_x , M_y , and M_z boxes, type in the required load, eccentricity, and moment values. Note that the thumbnail in the **Left Panel** show the sign convention for the forces, eccentricity, and moments. The eccentricity can be positive or negative based on the location of the point load to control how the additional created moments are applied to the model.
- From the OPTIONS select if you want to ADD TO EXISTING LOAD on the node or REPLACE EXISTING LOAD completely.
- Next, click on the location you want the load to be assigned to. You can also marquee select a group of nodes to assign all of them the same point load.

5.2.4.5. Nodes

You can create **Nodes** scope using the **Nodes** command from the **Ribbon**.

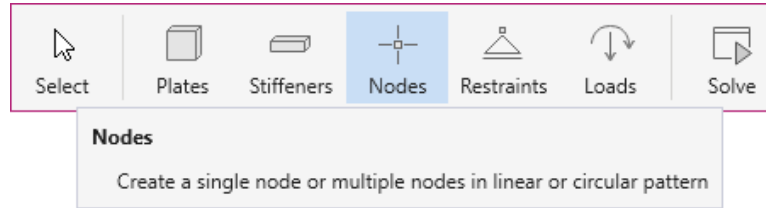

You can draw a **Single** node, nodes in **Linear** arrangement or nodes in **Circular** arrangement by using one of the following three tools in the **Nodes Left Panel**. The node patterns are useful in support and load applications that are of circular and linear patterns. Rectangular or triangular patterns can be created using the combination of linear and/or single nodes.

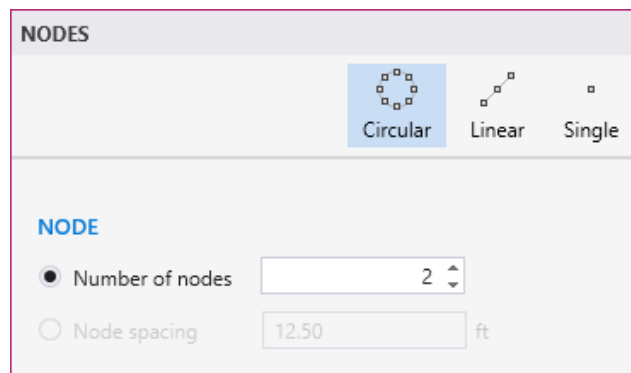

To draw nodes, first select the desired **Nodes** Tool.

- Select the NUMBER OF NODES or the NODE SPACING option for the **Circular** and/or **Linear** tools and enter the desired number of nodes to be created or the spacing at which the nodes are to be distributed.
- Then click on the workspace to begin drawing. If you have selected the **Single** node tool then the node is created at the point you click.
- Move your mouse until the desired size is achieved and click again to finish drawing.
- You can also marquee select grid intersections to assign multiple nodes at them.

Alternately you can also use dynamic input box.

- To display a dynamic input box, press ENTER after you have selected the node tool and decided on the number or spacing of the nodes to be created.

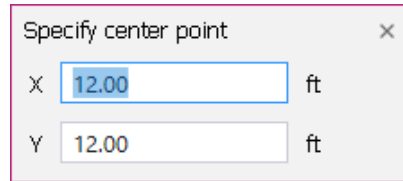

Specify center point

X 12.00 ft

Y 12.00 ft

- You will be required to provide the starting point (center point for **Circular** node distribution).
- Type in the required coordinates and press ENTER.
- If you have selected the **Single** node tool then the node is created at the point you specify.
- Press ENTER once more to display the dynamic input box again. Type in the required quantities i.e. X and Y coordinates of the end points for linear node distribution or radius for the circular node distribution and press ENTER to finish drawing.

5.2.5. Editing Model Objects

The model can be edited by using the **Left Panel**, **Left Panel Toolbar** or by using right-click at **Viewport**.

5.2.5.1. Using the Left Panel Objects

The **Objects** that can be edited are: **Plates** and **Stiffeners**.

Plates

The corresponding **Plates Left Panel** provides various tools and options for effectively working with **Plates**. You must have the **Select** command button toggled on to edit the **Plates**.

To edit a plate section or properties:

- Click on the plate to select it.
- Then in the **Left Panel**, simply change the desired parameter.
- If the given set of parameters match the parameters of a pre-defined plate, the new plate will automatically be assigned the existing label.
- If the given set of parameters do not match the parameters of any pre-defined plate, the plate will be assigned a new definition.

Stiffeners

The corresponding **Stiffeners Left Panel** provides various options for effectively working with **Stiffeners**. You must have the **Select** command button toggled on to edit the **Stiffeners**.

To edit a stiffener section or properties:

- Click on the stiffener to select it.
- Then in the **Left Panel**, simply change the desired parameter.
- If the given set of parameters match the parameters of a pre-defined stiffener, the new stiffener will automatically be assigned the existing label.
- If the given set of parameters do not match the parameters of any pre-defined stiffener, the stiffener will be assigned a new definition.

Restraints

The corresponding **Restraints Left Panel** provides various options for effectively working with **Restraints**.

Nodal Restraints

spWall considers **Nodal** restraints (nodal supports and nodal springs) as nodal properties. Therefore, to edit nodal restraints the corresponding nodes have to be selected.

To edit a single nodal restraint:

- Click on the node containing the nodal restraint you want to edit to display its properties and position in the **Left Panel**.
- Change the desired nodal restraint parameter.

To edit multiple nodal restraints at once:

- Use marquee select to select multiple nodes with desired nodal restraints.
- Change the desired nodal restraint parameter or parameters.

Linear Restraints

Linear restraints can only be assigned to **Stiffeners**. Therefore, to edit linear restraints the corresponding stiffeners have to be selected.

To edit a single linear restraint:

- Click on the stiffener containing the linear restraint you want to edit to display its properties and position in the **Left Panel**.
- Change the desired linear restraint parameter.

To edit multiple linear restraints at once:

- Use marquee select to select multiple stiffeners with desired linear restraints.
- Change the desired linear restraint parameter or parameters.

Loads

The corresponding **Loads Left Panel** provides various options for effectively working with **Loads**.

Editing Linear Area Loads

In spWall **Linear Area** loads can only be assigned to **Plates**. Therefore, to edit **Linear Area** loads, the corresponding plates have to be selected.

To edit a linear area load:

- Click on the plate containing the load you want to edit to display its properties and position in the **Left Panel**.
- Change the load value as desired.

To edit multiple linear area loads at once:

- Use marquee select to select multiple plates with desired loads.
- Change the load value as desired.

Editing Uniform Area Loads

In spWall **Uniform Area** loads can only be assigned to **Plates**. Therefore, to edit **Uniform Area** loads, the corresponding plates have to be selected.

To edit a uniform area load:

- Click on the plate containing the load you want to edit to display its properties and position in the **Left Panel**.
- Change the load value as desired.

To edit multiple uniform area loads at once:

- Use marquee select to select multiple plates with desired loads.
- Change the load value as desired.

Editing Uniform Line Loads

In spWall **Uniform Line** loads can only be assigned to **Stiffeners**. Therefore, to edit **Uniform Line** loads, the corresponding stiffeners have to be selected.

To edit a uniform line load:

- Click on the stiffener containing the load you want to edit to display its properties and position in the **Left Panel**.
- Change the load value as desired.

To edit multiple uniform line loads at once:

- Use marquee select to select multiple stiffeners with desired loads.
- Change the load value as desired.

Editing Point Loads

spWall considers **Point** loads as nodal properties. Therefore, to edit **Point** loads the corresponding nodes have to be selected.

To edit a single point load:

- Click on the node containing the load you want to edit to display its properties and position in the **Left Panel**.
- Change the desired load parameter.

To edit multiple point loads at once:

- Use marquee select to select multiple nodes with desired loads.
- Change the desired load parameter or parameters.

Nodes

The corresponding **Nodes Left Panel** provides various tools and options for effectively working with **Nodes**. You must have the **Select** command button toggled on to edit **Nodes**.

To edit a single node:

- Click on the node you want to edit to display its properties and position in the **Left Panel**.
- Change the desired node parameter.

To edit multiple nodes at once:

- Use marquee select to select multiple nodes at once.
- Edit the desired nodal properties from the **Left Panel**.

5.2.5.2. Using the Left Panel Toolbar

You must have the **Select** command button toggled on in order to use the tools available in the **Left Panel Toolbar**. You can use the tools in the **Left Panel Toolbar** to edit various model items.

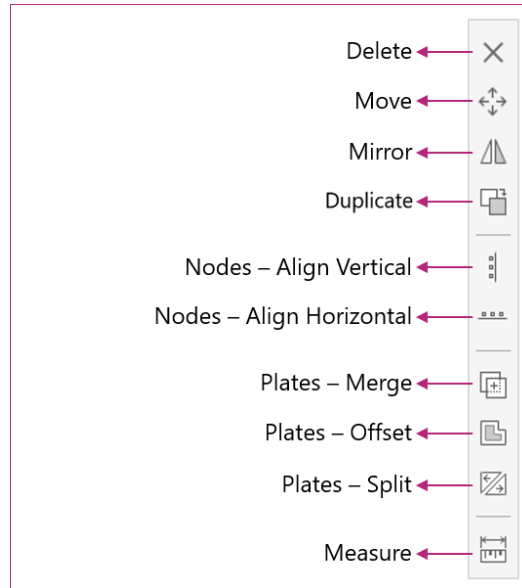

Delete

The **Delete** command is active only when one or more items are selected.

- Select the item or items you want to remove from the model and click **Delete** to remove.

Move

The **Move** command is active only when one or more items are selected.

- Select the item or items you want to move and click the **Move** command.
- Click on the screen to specify the base point from which to start moving. Alternatively, you can also press `ENTER` and manually enter the coordinates of the base point.
- Drag the selected items to the desired location and click to complete moving. Alternatively, you can also press `ENTER` and enter the translation vector to move the selected items to their new location.

Mirror

The **Mirror** command is active only when one or more items are selected.

- Select the item or items you want to mirror and click the **Mirror** command.
- Click on the screen to specify the start point of the mirror line.
- Alternatively, you can also press ENTER and manually enter the coordinates of the start of the mirror line.
- Next click on the screen to specify the end point of the mirror line.
- Alternatively, you can also press ENTER and manually enter the coordinates of the end point of the mirror line.

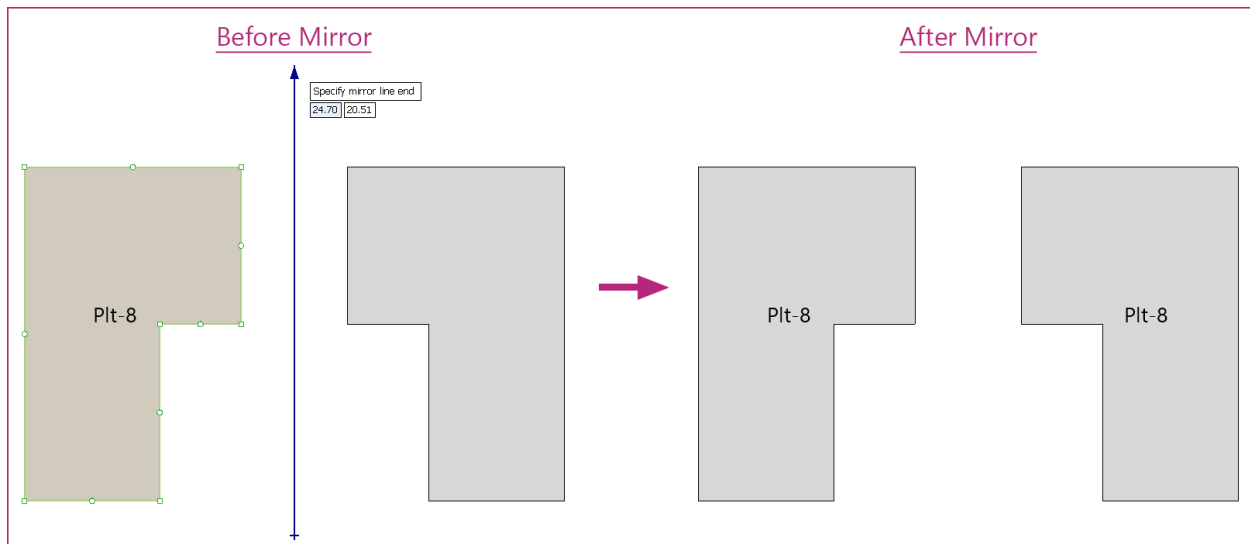

Duplicate

The **Duplicate** command is active only when one or more items are selected.

- Select the item or items you want to duplicate of and click the **Duplicate** command.
- Click on the screen to specify the base point from which to start the duplicate process. Alternatively, you can also press ENTER and manually enter the coordinates of the base point.
- Drag the duplicated items to the desired location and click to create a new instance. Alternatively, you can also press ENTER and enter the translation vector to move the duplicated instances of items to their new location.

Align Vertical

The **Align Vertical** command is active only when one or more model items are selected. This command is used to eliminate very small difference in location coordinates that could result in unwanted elements with an irregular or high aspect ratio.

- Select the item or items you want to align vertically in a straight line and click the **Align Vertical** command.
- Click on the screen to specify the reference X point at which to vertically align all the selected items.
- Alternatively, you can also press ENTER and manually enter the coordinate of the X reference point and press ENTER to complete alignment.

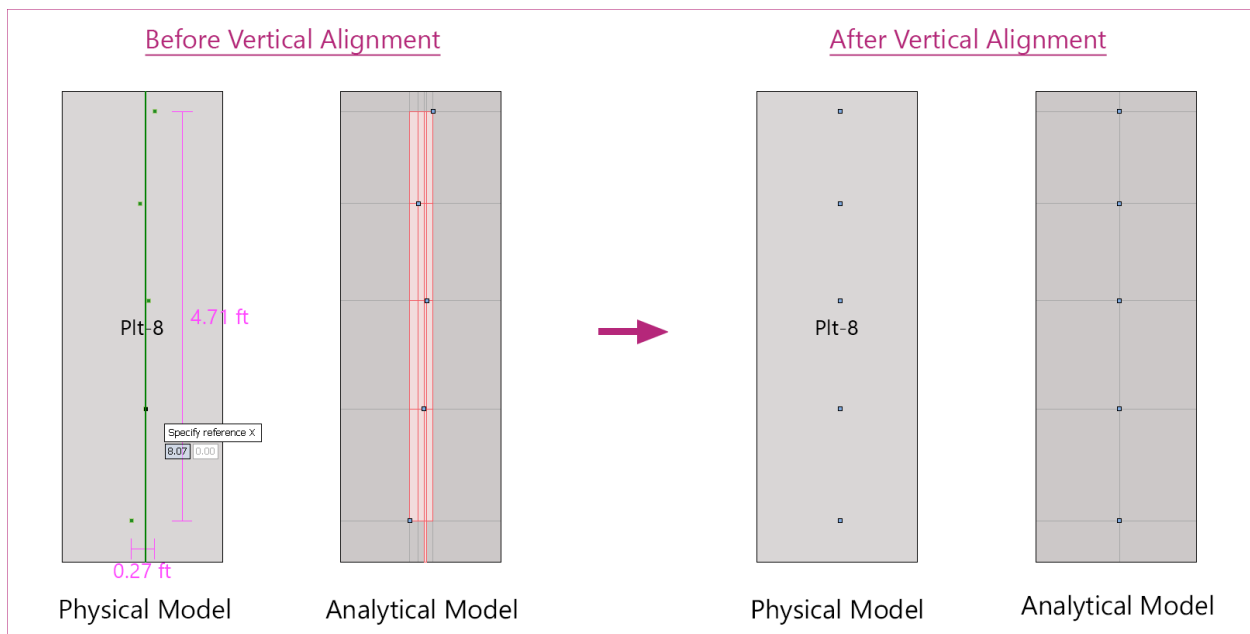

Align Horizontal

The **Align Horizontal** command is active only when one or more items are selected. This command is used to eliminate very small difference in location coordinates that could result in unwanted elements with an irregular or high aspect ratio.

- Select the item or items you want to align horizontally in a straight line and click the **Align Horizontal** command.
- Click on the screen to specify the reference Y point at which to horizontally align all the selected items.
- Alternatively, you can also press ENTER and manually enter the coordinate of the Y reference point and press ENTER to complete alignment.

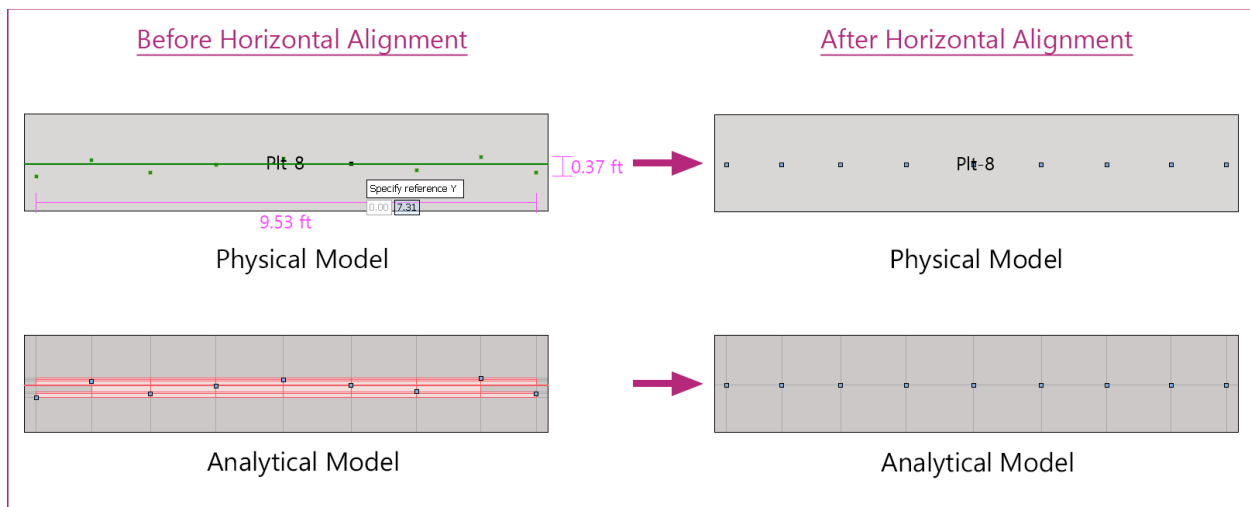

Plates - Merge

The **Plates - Merge** command is active only when more than one plates are selected.

- Select the plates that you want to merge and click the **Plates - Merge** command.
While merging two or more plates, the program requires you to select a reference plate, the properties of which will be applied to the final merged plate. These include section type and thickness along with properties like concrete, reinforcement, design criteria, cracking coefficient and any area loads applied.
- Click on plate whose properties you want the final merged plate to contain.

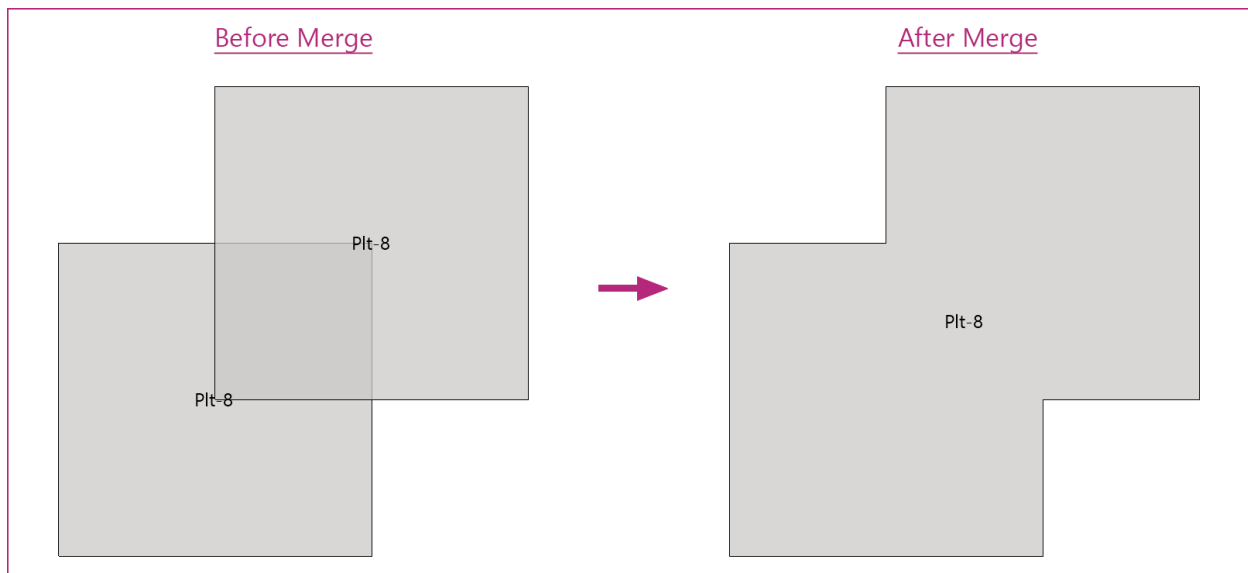

Plates - Offset

The **Plates - Offset** command is active only when one plate is selected. It is used to enlarge or reduce a plate overall size proportionally all around the perimeter to create accommodation for architectural or other features in a plate element.

- Select the plate that you want to offset and click the **Plates - Offset** command.
It is possible to offset the plate inwards or outwards.
- Click the side of the plate you want to offset.

- In the input box that appears, specify the offset distance and press ENTER.

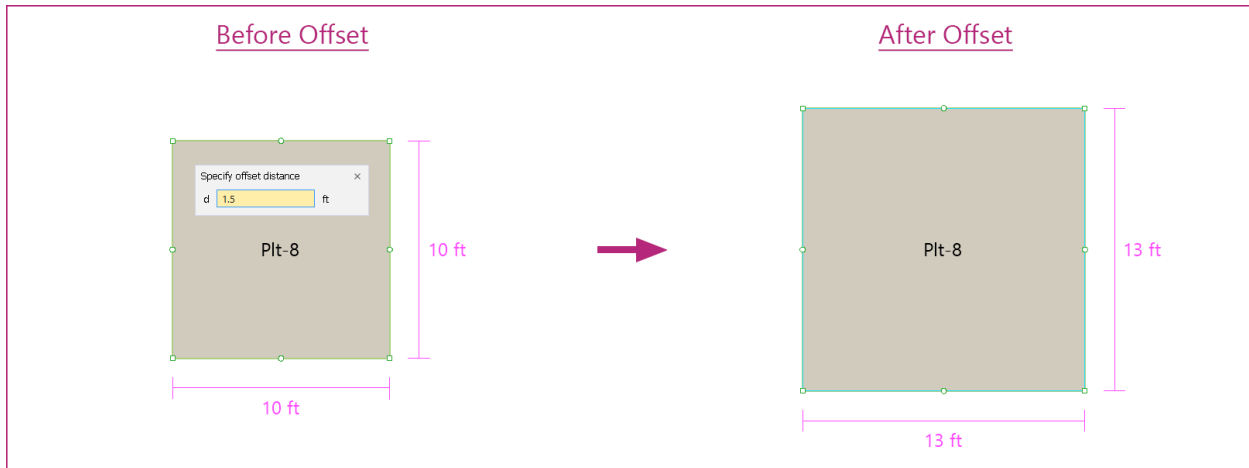

Plates - Split

The **Plates - Split** command is active only when one or more plates are selected. Splitting a plate is useful in situations where different load or support options need to be assigned to two separate parts of a plate created previously.

- Select the plates that you want to split and click the **Plates - Split** command.
- Click on the screen to specify the start point of the cutting line.
- Alternatively, you can also press ENTER and manually enter the coordinates of the start of the cutting line.

Note that a plate can be split only if the cutting line starts from outside or one edge of the plate and extends to or beyond the other edge of the plate. Starting a cutting line from any point within a plate will not cut that particular plate.

- Next click on the screen to specify the end point of the cutting line.
- Alternatively, you can also press ENTER and manually enter the coordinates of the end point of the cutting line.

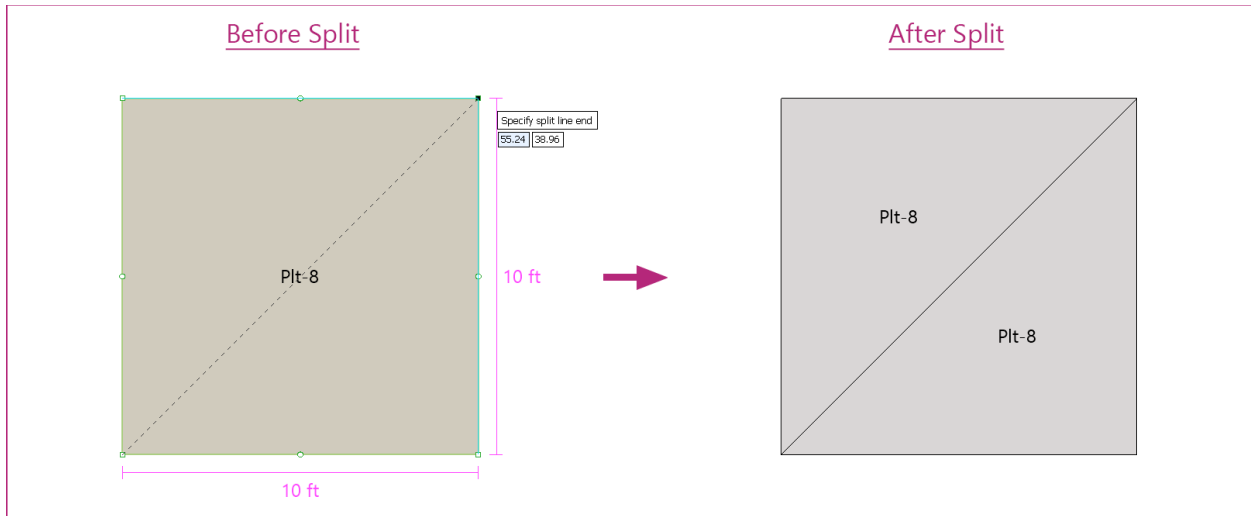

Measure

The **Measure** command is always active and can be used to measure distance between any two points. This command is particularly useful for obtaining the distance between two points along a diagonal.

- Click on the screen to specify the start point. Alternatively, you can also press ENTER and manually enter the coordinates of the start point.
- Click on the screen to specify the end point. Alternatively, you can also press ENTER and manually enter the coordinates of the end point.

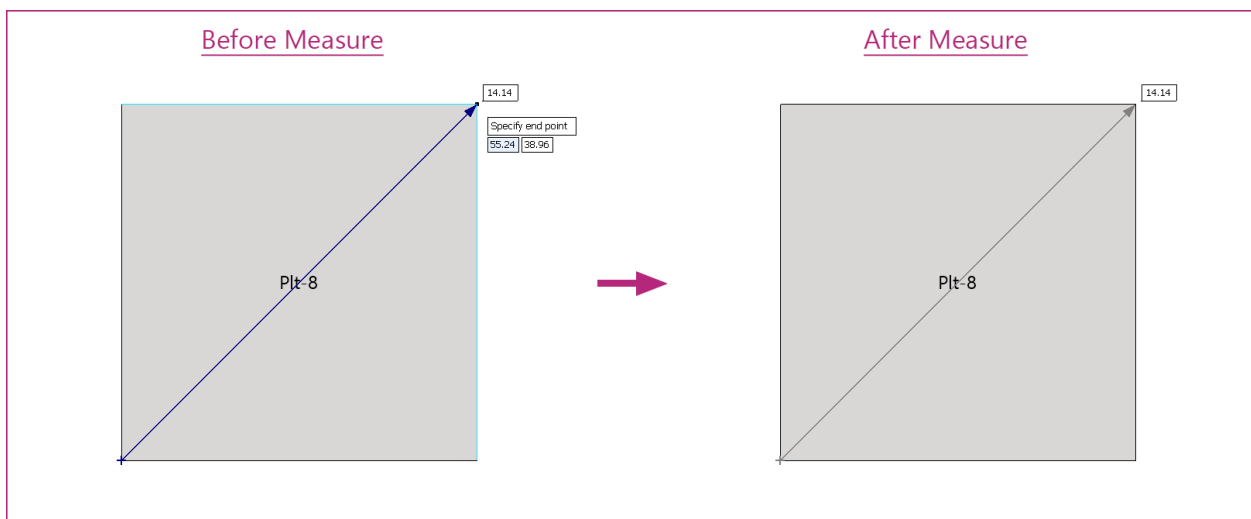

5.2.5.3. Using the Right Click Menu at Viewport

All the tools in the **Left Panel Toolbar** are also available in the **Right Click Menu at Viewport** when the **Select** command button is toggled on.

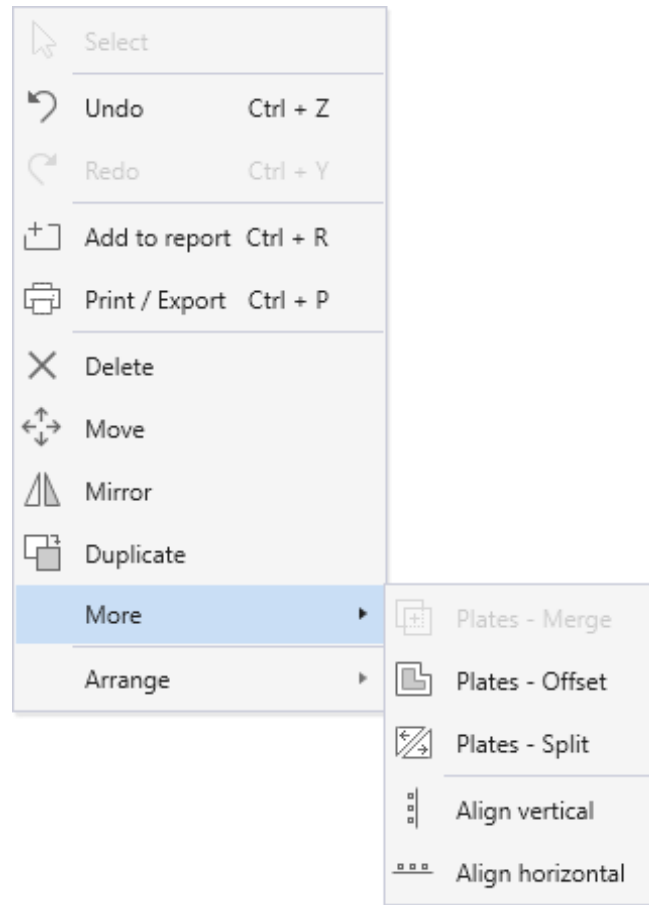

5.2.5.4. Understanding Plate Layers

While creating models, the need may arise to place one plate on top of another. In this case the properties (including the area load applied on the plate) of the plate on top are considered for solving the model. During modeling, a plate drawn later is always placed above the plate drawn first.

To move a **Plate** above or below another one:

- Click on the plate to select it.
- Then right click on it to show the **Right Click Menu**.

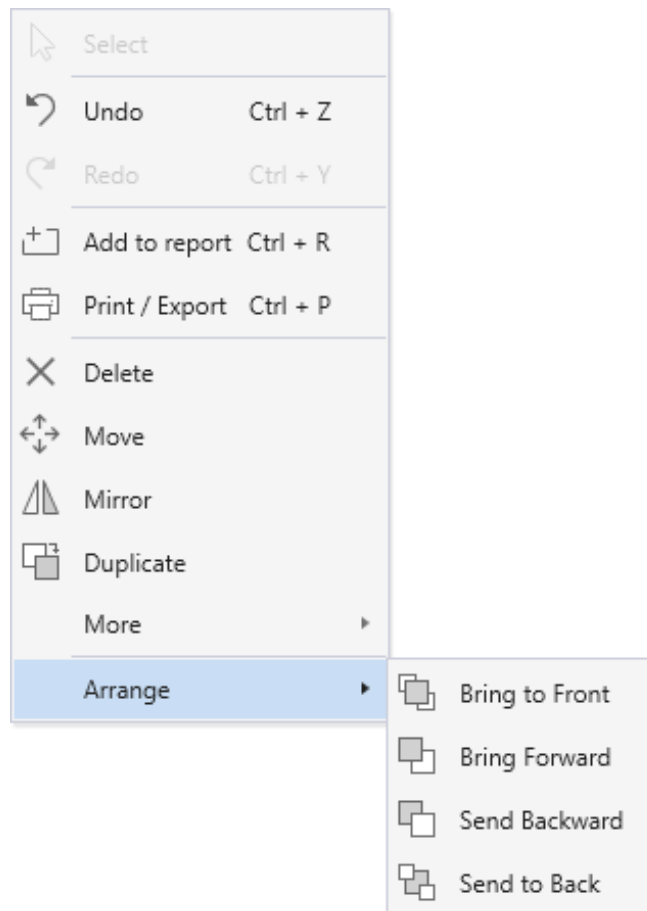

- From the **Arrange** sub menu, select the desired action.

It should be noted that openings are always on top regardless of the order they are drawn in.

5.3. Modeling with Templates

5.3.1. Utilizing Templates

Templates are an option for creating new models in the spWall program. It enables the user to select from a set of pre-defined templates and edit them for quick model generation.

To begin, go to the **Start Screen** under **Projects** and select the **Templates** option. This will take you to the TEMPLATE selection Dialog Box.

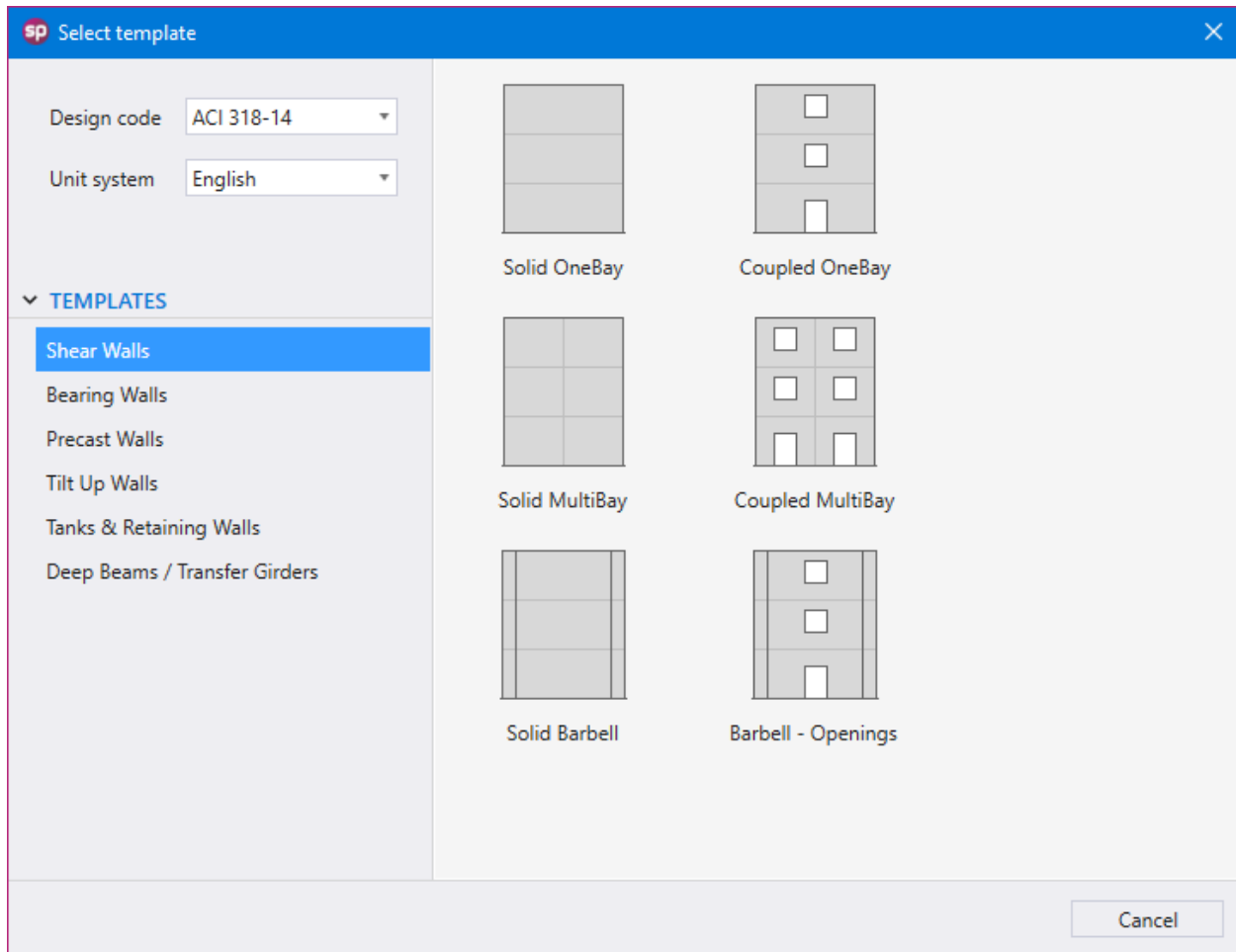

Here you can select the desired template along with the DESIGN CODE and UNIT SYSTEM. Clicking on a template image will open the **Template Module** and load the selected Template.

The screenshot displays the spWall software interface for model development. The main window is titled "spWall - Untitled" and features a menu bar (File, Home, Template) and a toolbar with icons for New Pattern, Discard & Exit, and Save & Exit.

The interface is divided into two main panels:

- Left Panel: Shear Walls: Barbell - Openings**
 - Diagram:** A 2D cross-section of a wall with openings, labeled with dimensions: W_s , W_h , W_w , S_h , S_{1h} , D_w , D_h , and B_w .
 - Wall Properties:**
 - Bay width (Bw): 25.00 ft
 - No. of Stories: 5
 - Story height (Sh): 12.00 ft
 - First story height (S1h): 14.00 ft
 - Thickness: 12.00 in
 - Openings:**
 - Window width (Ww): 4.00 ft
 - Window height (Wh): 6.00 ft
 - Window sill height (Ws): 2.00 ft
 - Door width (Dw): 4.00 ft
 - Door height (Dh): 8.00 ft
 - Stiffeners:**
 - Type: Rectangle
 - Width/Dia. (B): 24.00 in
 - Depth (D): 24.00 in
 - Supports:**
 - Stories: Lateral
 - Base: Fixed
 - Wall Properties:**
 - f_c : 4.0000 ksi
 - f_y : 60.0 ksi
 - No. of reinf. curtains: 2
 - Stiffener Properties:**
 - f_c : 4.0000 ksi
 - f_y : 60.0 ksi
 - DISPLAY OPTIONS:**
 - Dimensions:
 - Grid:
 - DL - Dead:
 - Extrude:
- Right Panel: Model View**
 - 3D Model:** A 3D perspective view of the wall with a grid. The wall is 25.00 ft wide and 62.00 ft high. It has a door at the bottom (14.00 ft high) and four windows above it (each 12.00 ft high). The grid lines are labeled 0, 1, 2, 3, 4, 5 vertically and A, B horizontally.
 - 2D Diagram:** A 2D cross-section diagram of the wall, showing the same dimensions and grid lines as the 3D model.

The bottom status bar shows "ACI 318-14" and "Units: English".

Once you are done editing the template to reflect your project criteria, you can click the **Save & Exit** button to take it to spWall for further modification or execution.

5.3.2. Template Ribbon

The **Template Ribbon** provides the following options:

New Pattern

Opens the TEMPLATE Selection Dialog Box. Selecting a New template will discard the old template and load the new one.

Discard & Exit

Discards the current template and exits to spWall home screen.

Save & Exit

Imports the current template to spWall.

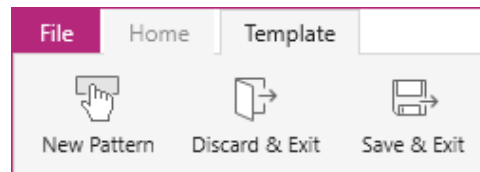

5.3.3. Template Left Panel

The **Left Panel** lists various template properties that can be modified by the user. The bottom part of the **Left Panel** consists of **Display Options**. You can use these to toggle on/off several **Viewport** items and also switch between displaying Load Cases.

Tilt Up Walls: MultiStory - MultiBay - Openings

Wall | Loads

- Wall**

Bay width (Bw)	15.00	ft
No. of bays	2	
No. of Stories	3	
Story height (Sh)	14.00	ft
First story height (S1h)	17.00	ft
Parapet height (Ph)	5.00	ft
Thickness	8.75	in
- Openings**

Window width (Ww)	11.00	ft
Window height (Wh)	9.00	ft
Window sill height (Ws)	1.00	ft
Door width (Dw)	11.00	ft
Door height (Dh)	12.00	ft
- Supports**

Stories	Lateral	▼
Base	Hinged	▼
- Properties**

f _c	4.0000	ksi
f _y	60.0	ksi
No. of reinf. curtains	2	▼
- DISPLAY OPTIONS**

<input checked="" type="checkbox"/> Dimensions	<input checked="" type="checkbox"/> Grid
DL - Dead	<input type="checkbox"/> Extrude

Tilt Up Walls: MultiStory - MultiBay - Openings

Wall | Loads

- Dead Loads**

Wy - Roof	-0.400	klf
Wy - Stories	-1.200	klf
- Live Loads**

Wy - Roof	-0.500	klf
Wy - Stories	-2.000	klf
- Dead & Live Loads Eccentricity**

Ez - Eccentricity	0.00	in
-------------------	------	----
- Lateral Loads**

Wz - Wind on wall	-30.0000	psf
Wz - Wind on openings	Top and Bottom	▼
- DISPLAY OPTIONS**

<input checked="" type="checkbox"/> Dimensions	<input checked="" type="checkbox"/> Grid
DL - Dead	<input type="checkbox"/> Extrude

5.3.4. Types of Templates

Shear Walls

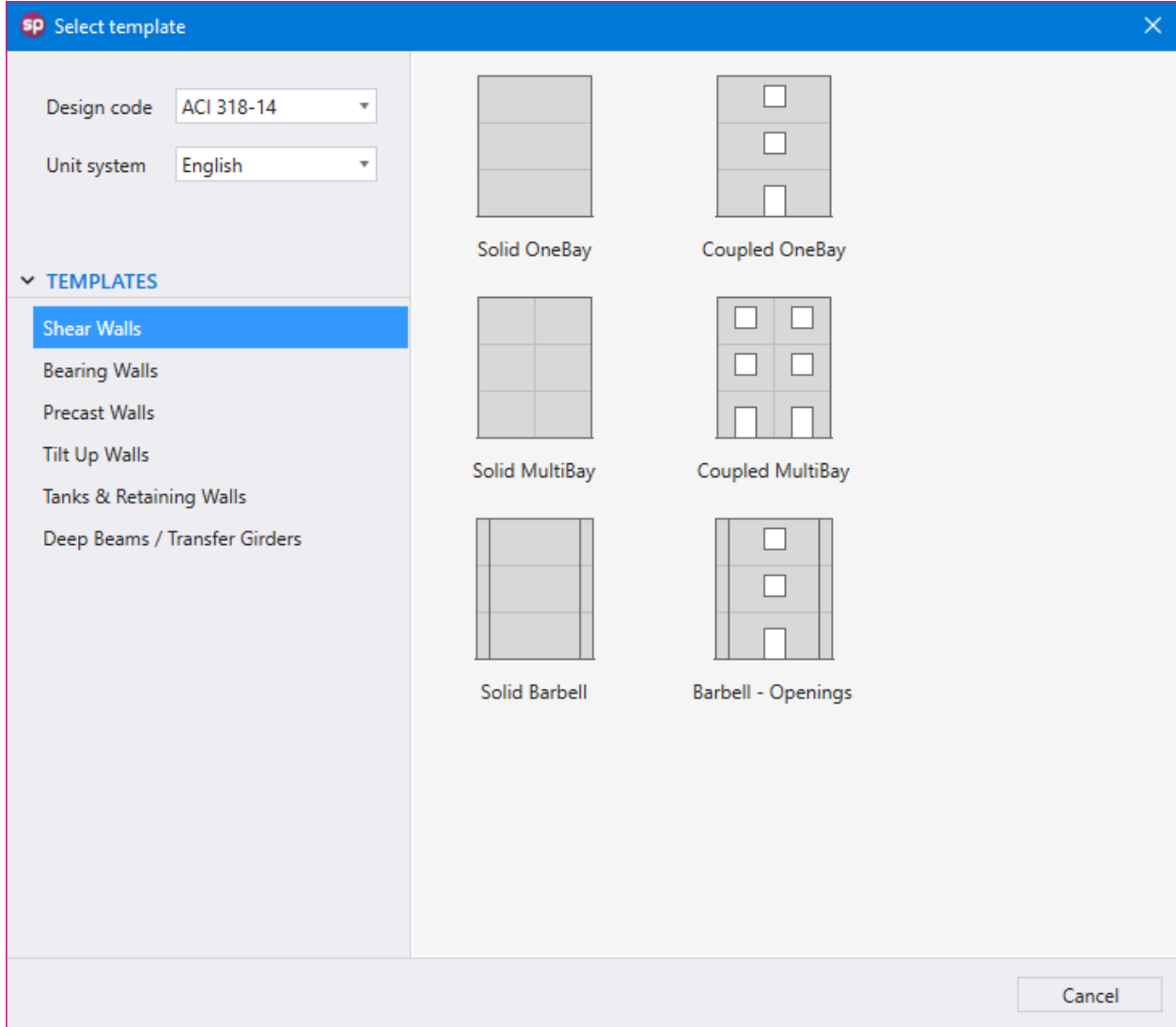

Bearing Walls

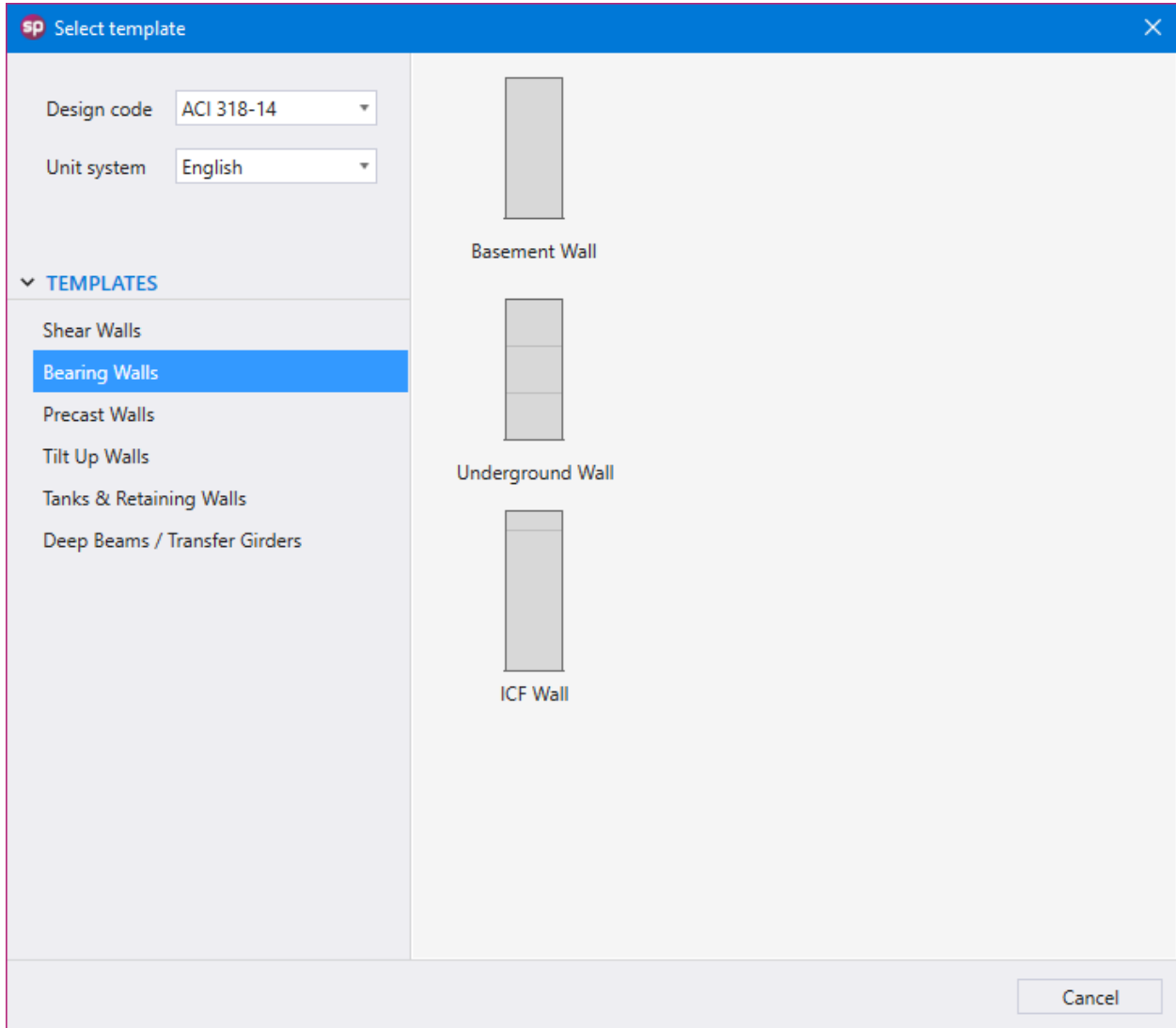

Precast Walls

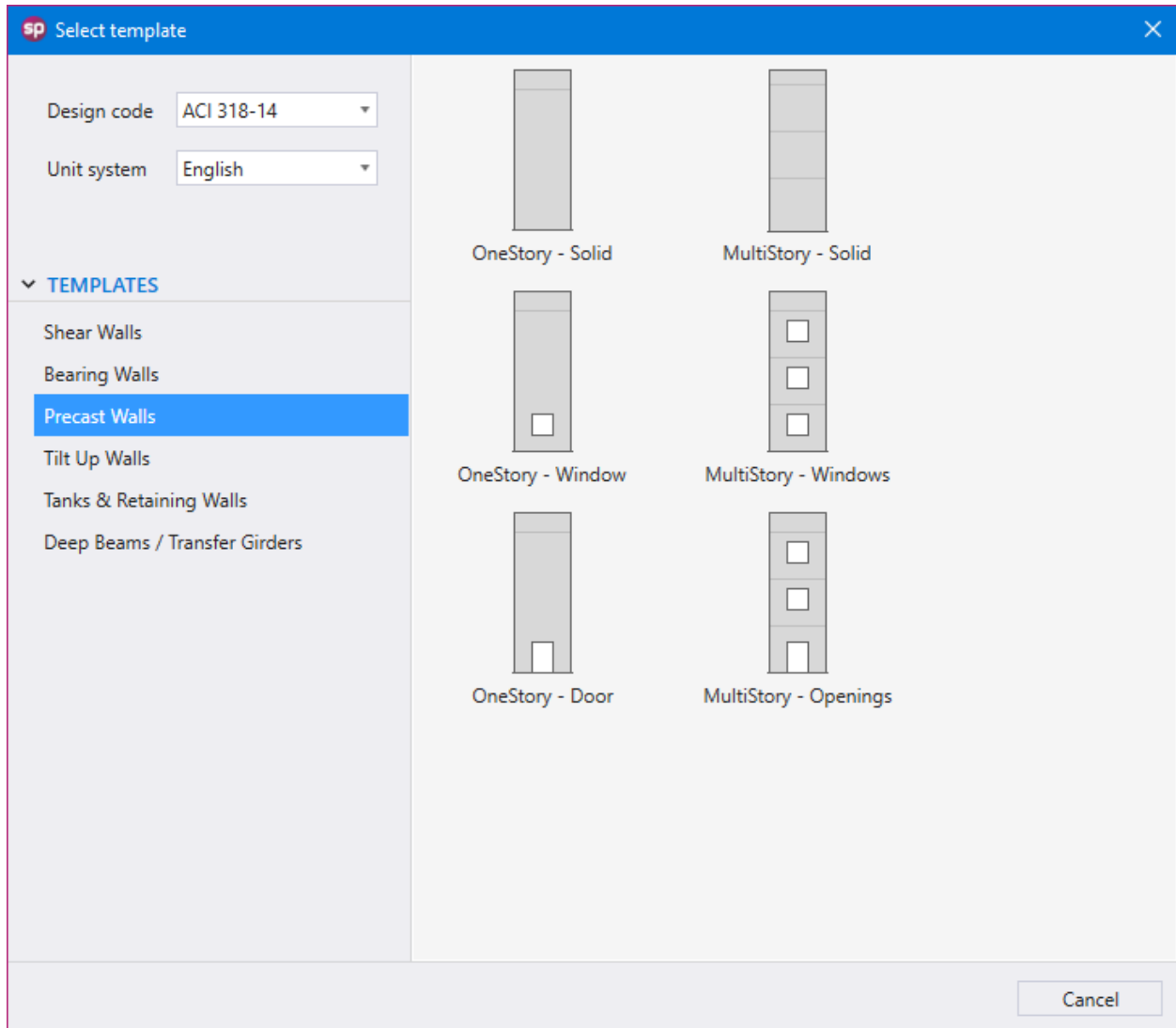

Tilt-Up Walls







sp Select template
✕

Design code

Unit system

▼ **TEMPLATES**

- Shear Walls
- Bearing Walls
- Precast Walls
- Tilt Up Walls
- Tanks & Retaining Walls
- Deep Beams / Transfer Girders

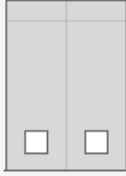
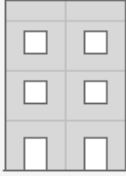
 OneStory - Solid	 MultiStory - Solid
 OneStory - Window	 MultiStory - Windows
 OneStory - Door	 MultiStory - Openings
 OneStory - MultiBay - Openings	 MultiStory - MultiBay - Openings

Tanks & Retaining Walls

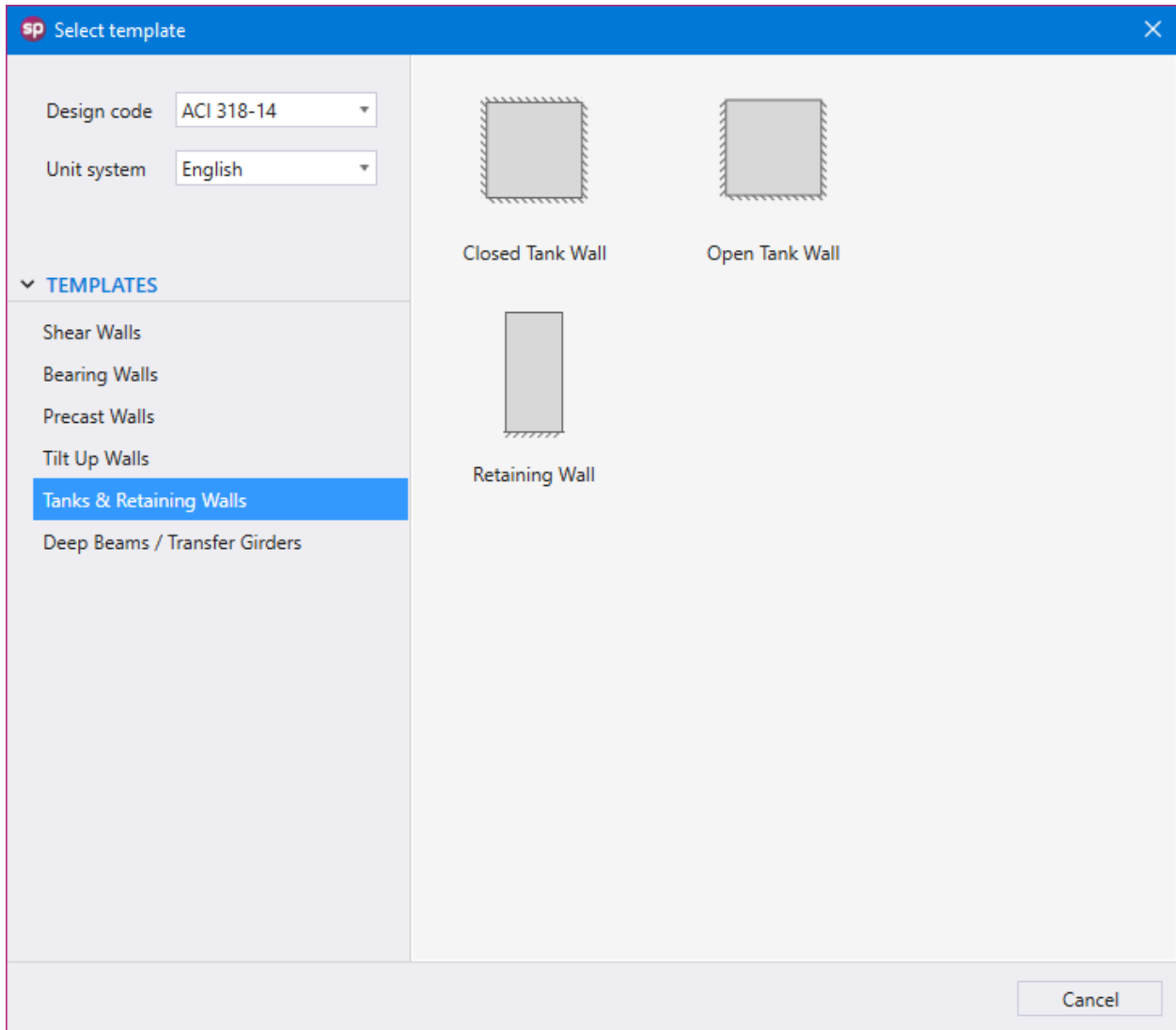

Deep Beams / Transfer Girders

sp Select template
✕

Design code ACI 318-14

Unit system English

▼ **TEMPLATES**

- Shear Walls
- Bearing Walls
- Precast Walls
- Tilt Up Walls
- Tanks & Retaining Walls
- Deep Beams / Transfer Girders



Uniformly Distributed Load

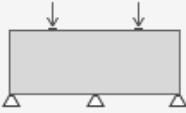

1 Point Load

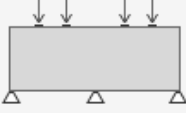

2 Point Load

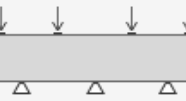

1 Point Load - Cantilevers

Cancel

5.4. Utilizing Predefined Examples

In the **Start Screen** under **Projects** select the **Examples** option. This will take you to the **Examples** folder under the spWall installation folder.

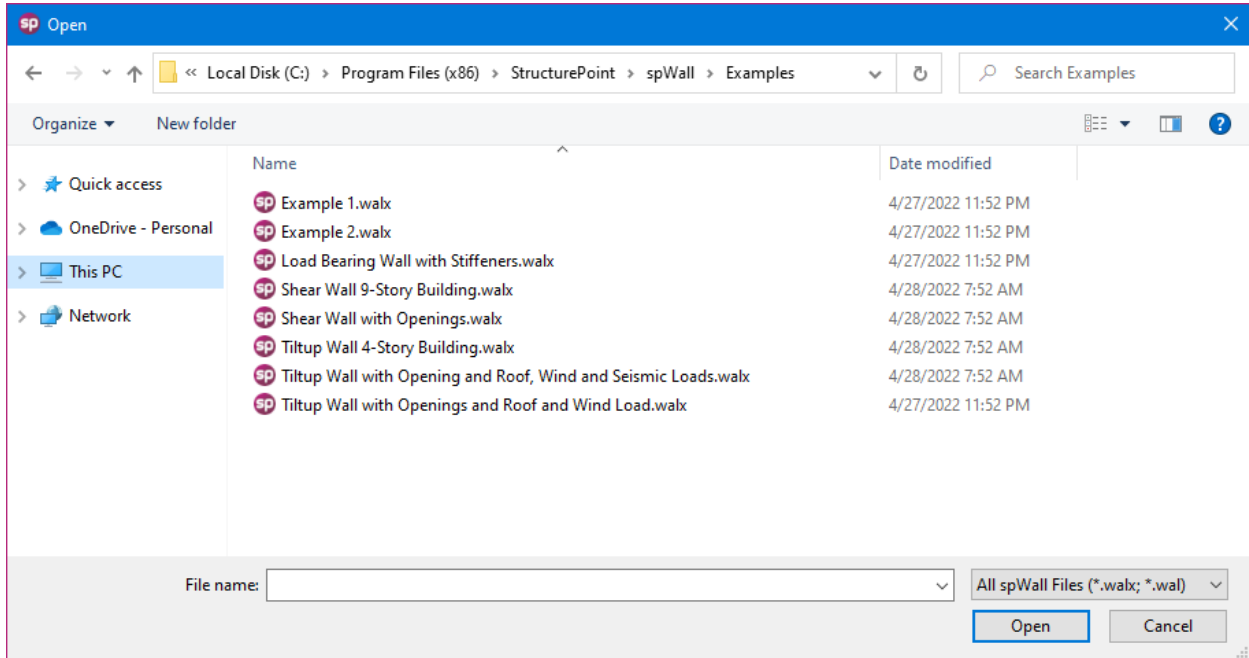

The **Examples** folder contains predefined wall models that can be further utilized by the user.

5.5. Importing Model Data

spWall provides the options to import GRIDS, POINT LOADS and LOAD CASES & COMBINATIONS data from a text file. The data import options can be obtained from **File | Import**.

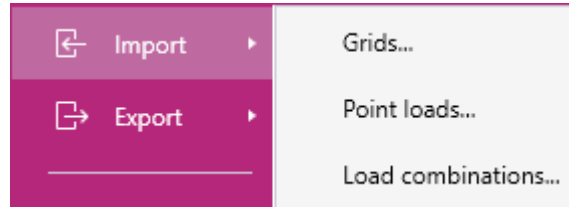

It should be noted that importing a data set will completely replace existing data of that particular set in the program. For details on the import file formats please refer to section [A.2. Import File Formats](#) in the **Appendix**.

5.6. Exporting Model Data

spWall provides the options to export GRID, POINT LOADS and LOAD CASES & COMBINATIONS data to a text file. The data export options can be obtained from **File | Export**.

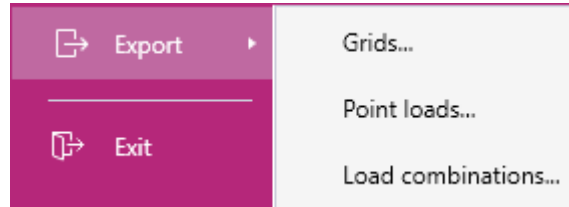

The exported data format will be the same as the import data format provided in section [A.2. Import File Formats](#) in the **Appendix**.

CHAPTER

6

MODEL SOLUTION

Once the model creation and development are completed, the analysis can begin using the spWall Finite Element Method (FEM) Solver by clicking on the **Solve** command. Solve Menu containing **Solve Options**, **Mesh Options** will appear on the **Left Panel**.

Solving the model is done in two steps. The “Run” button activates first the finite element analysis. In the second step, the program calculates the required area of steel for the plate and the stiffener elements. Any solver warnings or errors encountered during the solution are issued and recorded as solver messages in the results table.

6.1. Solve Options

The **Solve Options** allow the user to select run options and include second order effects, maximum allowed out-of-plan deflection limits, and choices for concrete shear strength calculations. These options are important to consider carefully as they can be useful to manage and control the model behavior and corresponding analysis results.

SOLVE

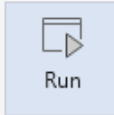

▼ **SOLVE OPTIONS**

Run Options	Analysis & Design	▼	
Include 2nd Order Effects	Yes	▼	
Max. allowed Out-of-Plane Deflection	H/150	▼	
User Defined allowed Deflection	11.00000	in	

Check Concrete Shear Strength of Wall Crosssections (ACI with Solid walls only)

Use Simplified Equations
 Use Detailed Equations (uniform walls only)

6.1.1. Run Options

Select “Analysis & Design” from the RUN OPTIONS dropdown to run both FEM analysis and design. If only the design portion of the solution needs to be re-run – e.g., due to a change in input that affects design only such as definition of reinforcing steel or design criteria – then the “Design” option may be selected. The program will run the design procedures without reinvoking the finite element solution which may be time consuming for larger models with many load combinations.

6.1.2. Second Order Effects

Select “Yes” from the INCLUDE 2ND ORDER EFFECTS drop down menu to have the program perform second order analysis in which the out-of-plane (bending) action is magnified according to the values of the in-plane forces and the out-of-plane deflections. When “No” is selected, the program performs first order analysis. See the discussion in Chapter 2.

6.1.3. Maximum Allowable Out-of-Plane Deflection

Select an option to check displacement calculated for service load combinations against a maximum allowable out-of-plane deflection. There are three options available:

- “Disable”: No displacement check is performed.
- “H/150”: Service load combinations out-of-plane deflections are checked against allowable deflection calculated by the program as $H/150$, where H is the overall height of the wall. The H value is used instead of length between supports (l_c or l) because values of l_c (or l) cannot be accurately determined by the program due to arbitrary wall geometries and support conditions available in the program. If approximation with H is not acceptable then the user can specify the exact value of the allowable deflection using the “User Defined” option described below.
- “User Defined”: Service load combinations out-of-plane deflections are checked against allowable deflection specified by the user. Deflections that exceed the allowable value are flagged in the results report.

6.1.4. Concrete Shear Strength of Wall Cross-Sections

Select an option for checking shear strength of wall cross-sections provided by concrete. These options are only available for ACI and only for solid walls, i.e. walls without openings. Refer to [Section 2.7.2](#) in Chapter 2 of the manual for more information.

6.2. Meshing Options

Unlike earlier versions of spWall where the physical model contains the finite element mesh through the creation of grids at the first step of model creation, spWall v10.00 separates the physical model generation from the analytical model. It allows the user to define parameters for the Finite Element mesh generation at the **Solve** Menu. The parameters that can be set by the user are discussed below:

MESH OPTIONS		
Max. allowed mesh size	2.00	ft
Max. allowed aspect ratio	10	
Circle segments	36	▼
Status		
Number of elements	1190	
Min. element size	2.00	ft
Max. element size	2.00	ft
Max. aspect ratio	1.00	

6.2.1. Maximum Allowed Mesh Size

The MAX. ALLOWED MESH SIZE for the analytical model is a user input that is set to an initial default value of 2.00 ft by the Program and can be changed by the user based on the specific model needs. As a rule of thumb, as the mesh size gets finer, the results become more accurate. The plate vertices, stiffener vertices, node, restraint, and point load locations automatically get a finite element mesh grid. The factors that may be considered in the maximum allowed mesh size selection are the plate thickness, and the overall elevation dimensions of the plate.

6.2.2. Maximum Allowed Aspect Ratio

The MAX. ALLOWED ASPECT RATIO **Analytical Model Option** is a user input that is set to an initial default value of 10 by the Program and can be changed by the user based on the specific model needs. As a rule of thumb, as the aspect ratio gets closer to 1, the results become more accurate.

6.2.3. Circle Segments

The CIRCLE SEGMENTS **Analytical Model Option** is a user input that is set to an initial default value of 36 by the Program and can be changed by the user to 24 or 48 based on specific model needs. This option is utilized for circular plates.

6.2.4. Status

This section lists the number of elements, minimum and maximum element sizes in the model along with the maximum aspect ratio. If the maximum aspect ratio of an element in the model is greater than the defined maximum allowed aspect ratio then the maximum aspect ratio value is highlighted along with all the elements in the mesh whose aspect ratios exceed the maximum allowed aspect ratio. The user is warned before the program invokes the solver.

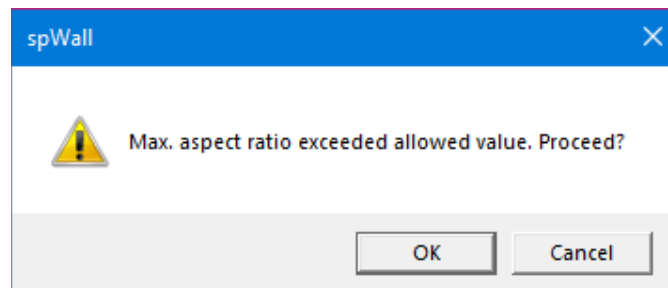

6.3. Running the Model

After inputting the model, the solver portion of the program can be executed using the **Run** button in the SOLVE panel.

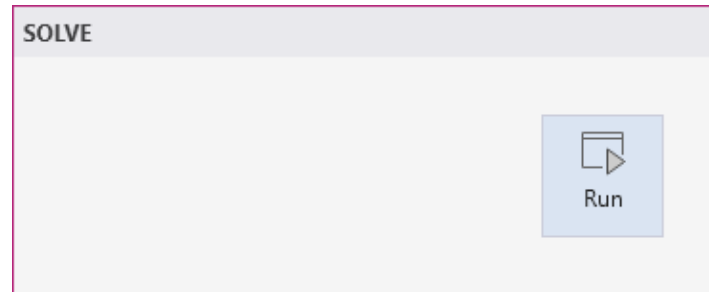

After you click the **Run** button, the program then switches control to the **Solver Module**. A dialog box reporting the progress and status of the solution is displayed.

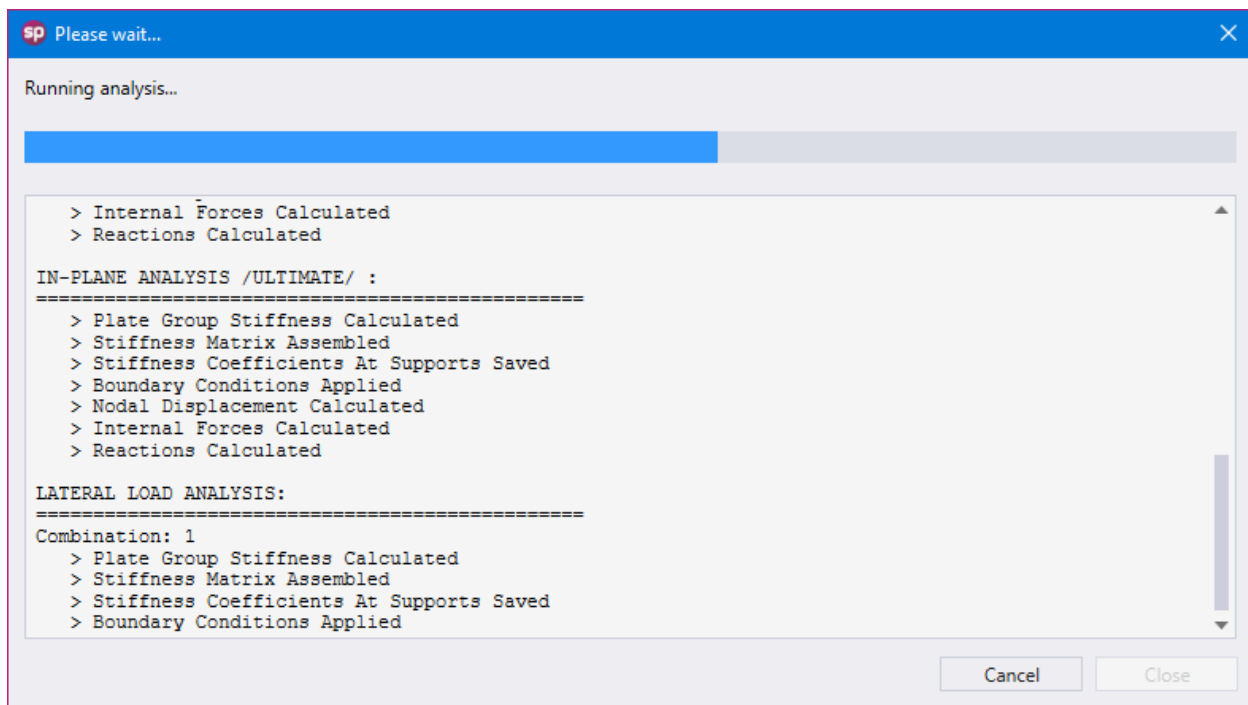

When the solution is successfully completed, a contour map showing the service displacement envelope (in the positive x direction) is displayed. If the solution procedure fails, a message box appears. Detailed information on the solution can be found in the **Solver Messages Dialog** under **Tables Window**.

CHAPTER

7

MODEL OUTPUT

The results of the finite element analysis and following design and code calculations are presented by spWall model output in two key categories.

- 1. Tabular Output:** Text results organized in tables including all relevant exact numerical results formatted in columnar tables.
- 2. Graphical Output:** Illustrating model behavior visually as an important and effective method to diagnose and verify expected results and critical parameters. Graphical output is presented as contours, diagrams, or other two-dimensional graphics.

A detailed description of all the features of both output types is given below.

7.1. Tabular Output

The Tabular output can be found both in the **Tables Module** and the **Reporter Module**. The **Tables Module** may be utilized to view and export the model output at any model development stage. The **Reporter Module** may be utilized to create, export and print customized reports when the design is finalized. Both modules have the same output sections. The differences being that of the **Reporter Module** contains the cover & contents, and screenshots sections. The **Tables Module** contains the **Solver Messages** section which includes any warnings or error statements reported during the model execution. The tables may be fully or partially output for all or for only selected nodes, and elements using the Ranges section of the results explorer panel. Selecting “All” nodes or elements provide the complete output for each category in the results table.

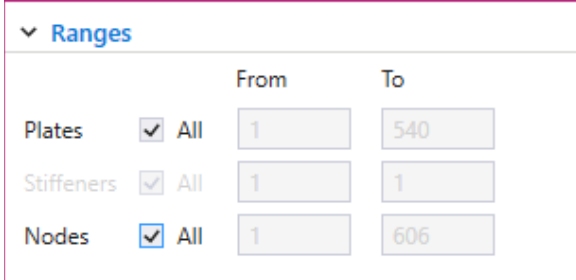

		From	To
Plates	<input checked="" type="checkbox"/> All	1	540
Stiffeners	<input checked="" type="checkbox"/> All	1	1
Nodes	<input checked="" type="checkbox"/> All	1	606

The program distinguishes between individual (service or ultimate) combination results and envelope results (which include the maximum values from all load combinations).

Contour views are also provided for selected output results to facilitate the graphical examination of results by the user. However, the tabular results reports should be used to make and finalize modeling decisions.

The Tabular output contains the following common input and results sections:

7.1.1. Project

This section contains the following input data blocks:

General Information

This block contains the information regarding to the **Project** such as FILE NAME, PROJECT NAME, DESIGN CODE, UNITS, DATE and TIME.

Solver Options

This block contains the information regarding to the **Solver Options** input entered by the user.

7.1.2. Definitions

This section contains the following **Definitions** input data subsections:

Grid Lines

This subsection contains the information regarding to the definitions input data for **Grids** utilized in the model. This subsection has data blocks for X – VERTICAL and Y – HORIZONTAL grid input data.

Objects

This subsection contains the information regarding to the definitions input data for **Objects** utilized in the model. This subsection has data blocks for PLATES, STIFFENERS – PROPERTIES, and STIFFENER – GEOMETRY input data.

Properties

This subsection contains the information regarding to the definitions input data for **Properties** utilized in the model. This subsection has data blocks for CONCRETE, REINFORCEMENT, PLATE CRACKING COEFFICIENTS, PLATE DESIGN CRITERIA, STIFFENER CRACKING COEFFICIENTS, and STIFFENER DESIGN CRITERIA input data.

Restraints

This subsection contains the information regarding to the definitions input data for **Restraints** utilized in the model. This subsection has data blocks for SUPPORTS, and SPRINGS input data.

Load Cases / Load Combinations

This subsection contains the information regarding to the definitions input data for **Load Case / Combo.** utilized in the model. This subsection has data blocks for LOAD CASES and LOAD COMBINATIONS input data.

7.1.3. Assignments

This section contains the following **Assignments** input data blocks:

Nodes

This block contains the **Nodes** input data such as NODE ID, COORDINATES, and ASSIGNMENTS FOR RIGID SUPPORT and SPRING SUPPORTS.

Plates

This block contains the **Plates** input data such as ID, LABEL, SHAPE and GEOMETRIC INFORMATION.

Stiffeners

This block contains the **Stiffeners** input data such as ID, LABEL, DIRECTION, COORDINATES, LENGTH, and ASSIGNED SUPPORT ID.

Point Loads

This block contains the **Point Loads** input data such as NODES ID, LOAD CASE, and LOAD VALUES & ECCENTRICITIES.

Uniform Area Loads

This block contains the **Uniform Area Loads** input data such as PLATE ID, LOAD CASE, and LOAD VALUES.

Linear Area Loads

This block contains the **Linear Area Loads** input data such as PLATE ID, LOAD CASE, TOP LOAD VALUES & LOCATION, and BOTTOM LOAD VALUES & LOCATION.

Uniform Line Loads

This block contains the **Uniform Line Loads** input data such as STIFFENER ID, LOAD CASE, and LOAD VALUES & ECCENTRICITIES.

7.1.4. Analytical Model

This section contains the following **Analytical Model** input data blocks:

Mesh

This block contains **Mesh** input data such as MAX. ALLOWED MESH SIZE, CIRCLE SEGMENTS and MESH STATUS.

Element Geometry

This block contains **Element Geometry** data for plate and stiffener elements such as ELEMENT NUMBER, NODE NUMBERS OF AN ELEMENT, DIMENSIONS, and THICKNESS (for plate elements).

Element Properties

This block contains **Element Properties** data labels for plate and stiffener elements such as PLATE/STIFFENER, CONCRETE, REINFORCEMENT, DESIGN CRITERIA, CRACKING COEFF. and whether the element LOADED or not.

Loaded Elements

This block contains **Loaded Elements** data for plate and stiffener elements showing the UNIFORM AND LINEAR AREA LOAD VALUES per load case for all loaded plate elements, and the UNIFORM LINE LOAD VALUES per load case for all loaded stiffener elements.

7.1.5. Results

This section contains the **Envelope**, the **Service**, and the **Ultimate** level results.

7.1.5.1. Envelope

This section contains the **Envelope** results information on **Service Displacements**, **Plate Flexure Reinforcement**, **Wall Concrete Shear Strength**, **Stiffener Flexure Reinforcement**, **Stiffener Shear Reinforcement**, **Stiffener Torsion Reinforcement**, and **Stiffener Reinforcement Summary**.

Service Displacements

This block contains the information regarding to the **Service Displacements** envelope.

The maximum positive (+ve) and maximum negative (-ve) displacements (D_x , D_y , and D_z) at each node are displayed. Displacement envelopes are calculated from the results of the service load combinations. Displacements are shown in the directions of the global axes.

Plate Flexural Reinforcement

This block contains the information regarding to the **Plate Flexural Reinforcement** envelope.

The required areas of steel and reinforcement ratio, in the horizontal direction and the vertical direction, in each plate element are reported. Half of the reported value applies to each curtain in models with two curtain layout. The block also shows the maximum ultimate design moment, the ultimate design axial force, the critical ultimate load combination that produces the smallest safety factor as well as the plate element design forces calculated for the critical load combination. See [Section 2.4.1](#) in Chapter 2 for discussion about calculating the design forces in plate elements.

Wall Concrete Shear Strength

This subsection contains the information regarding to the **In-Plane** and **Out-Of-Plane Wall Concrete Shear Strength**.

This portion of results is only available for solid walls designed in accordance with the ACI codes

and when the user selects the option to check concrete shear strength. Shear strength of wall cross sections directly above and directly below each horizontal grid line is reported for in-plane and out-of-plane directions. Shear strength provided by concrete is compared to the corresponding shear force for the load combination which results in the smallest safety factor.

Stiffener Flexure Reinforcement

This block contains the information regarding to the **Stiffener Flexure Reinforcement** envelope.

The portion of the longitudinal area of steel that resists flexure is reported for each stiffener element. The results also show, the critical ultimate load combination that produces the smallest safety factor as well as the stiffener element design forces calculated for the critical load combination.

Stiffener Shear Reinforcement

This block contains the information regarding to the **Stiffener Shear Reinforcement** envelope.

The total transverse reinforcement required to resist both shear and torsion is reported for each stiffener element. The results are shown for the Y and Z directions that are the local axes of the stiffener element. The results also show, the critical ultimate load combination that produces the smallest safety factor as well as the stiffener element design forces calculated for the critical load combination.

Stiffener Torsion Reinforcement

This block contains the information regarding to the **Stiffener Torsion Reinforcement** envelope.

The transverse and longitudinal reinforcement required to resist torsion only are reported for each stiffener element. The results also show, the critical ultimate load combination that produces the smallest safety factor as well as the stiffener element design forces calculated for the critical load combination.

Stiffener Reinforcement Summary

This block contains the information regarding to the **Stiffener Reinforcement Summary** envelope.

A summary of required transverse and longitudinal reinforcement are reported for each stiffener element.

7.1.5.2. Service

This section contains the **Service** level results information on **Nodal Displacements, Reactions, Sum of Reactions, Plate Internal Forces, and Stiffener Internal Forces.**

Nodal Displacements

This block is output for individual **Service Load Combinations**. It lists the **Nodal Displacement** for each load combination. The table lists the displacements (D_x , D_y , and D_z) at each node. Positive displacements are in the direction of the positive axes.

Reactions

This block is output for individual **Service Load Combinations**. It lists **Reactions** for the nodes with restraints. Positive translational reactions (forces) are in the direction of the positive axes and positive rotational reactions (moments) are determined using the right-hand rule.

Sum of Reactions

This block is output for individual **Service Load Combinations**. It lists the **Sum of Forces and Moments** (with respect to model center of gravity) for applied loads and reactions due to restraints.

Plate Internal Forces

This block is output for individual **Service Load Combinations**. It lists the **Plate Internal Forces** for each load combination. The table lists the in-plane forces (N_{xx} , N_{yy} , and N_{xy}), the bending moments (M_{xx} and M_{yy}) and the torsional moment (M_{xy}) in each plate element. Positive forces are in the direction of the positive axes and positive moments are determined using the right-hand rule.

Note that unlike in beams and columns, the traditional plate and shell theory convention is that M_{xx} denotes the moment along (not about) the X-axis and M_{yy} denotes the moment along the Y-axis. See Element Design Forces in [Section 2.4.1](#) of Chapter 2 of the manual for the sign convention.

Stiffener Internal Forces

This block is output for individual **Service Load Combinations**. It lists the **Stiffener Internal Forces** for each load combination. The table lists the internal forces (N_x , V_y , and V_z), the internal bending moments (M_y and M_z) and the torsional moment (T_x) in each stiffener element. Forces and moments are shown in the directions of the local axes of the stiffener element. See Element Design Forces in [Section 2.4.1](#) of Chapter 2 of the manual for the sign convention.

7.1.5.3. Ultimate

This section contains the **Ultimate** level results information on **Nodal Displacements, Reactions, Sum of Reactions, Plate Internal Forces, Stiffener Internal Forces, and Wall Cross-Sectional Forces**.

Nodal Displacement

This block is output for individual **Ultimate Load Combinations**. It lists the **Nodal Displacement** for each load combination. The table lists the displacements (D_x , D_y , and D_z) at each node. Positive displacements are in the direction of the positive axes.

Reactions

This block is output for individual **Ultimate Load Combinations**. It lists **Reactions** for the nodes with restraints. Positive translational reactions (forces) are in the direction of the positive axes and positive rotational reactions (moments) are determined using the right-hand rule.

Sum of Reactions

This block is output for individual **Ultimate Load Combinations**. It lists the **Sum of Forces and Moments** (with respect to center of gravity) for applied loads and reactions due to restraints.

Plate Internal Forces

This block is output for individual **Ultimate Load Combinations**. It lists the **Plate Internal Forces** for each load combination. The table lists the in-plane forces (N_{xx} , N_{yy} , and N_{xy}), the bending moments (M_{xx} and M_{yy}) and the torsional moment (M_{xy}) in each plate element. Positive forces are in the direction of the positive axes and positive moments are determined using the right-hand rule.

Note that unlike in beams and columns, the traditional plate and shell theory convention is that M_{xx} denotes the moment along (not about) the X-axis and M_{yy} denotes the moment along the Y-axis. See Element Design Forces in [Section 2.4.1](#) of Chapter 2 of the manual for the sign convention.

Stiffener Internal Forces

This block is output for individual **Ultimate Load Combinations**. It lists the **Stiffener Internal Forces** for each load combination. The table lists the internal forces (N_x , V_y , and V_z), the internal bending moments (M_y and M_z) and the torsional moment (T_x) in each stiffener element. Forces and moments are shown in the directions of the local axes of the stiffener element. See Element Design Forces in [Section 2.4.1](#) of Chapter 2 of the manual for the sign convention.

Wall Cross-Sectional Forces

This block is output for individual **Ultimate Load Combinations**. It lists the **Wall Cross-Sectional Forces** for each load combination. The table lists the cross-sectional forces (N_{uy} , V_{ux} , and V_{uz}) and moments (M_{ux} , M_{uy} , and M_{uz}) at wall sections directly above and directly below each horizontal grid line. The forces and moments are calculated with respect to centroid of the section based on loads and reactions for the selected ultimate load combination. Forces and moments are shown in the directions of the global axes and are subdivided into in-plane and out-plane categories. Only forces transferred by plate elements are considered, i.e. if a wall section intersects stiffeners then forces transferred by stiffeners are excluded and reported separately as stiffener internal forces.

7.2. Graphical Output

The Graphical output is organized into **Contours** and **Diagrams** views that may be viewed, printed, exported or added to Report.

7.2.1. Contours

Contour views are used to facilitate the graphical examination of the results by the user. Contour views show the results in three distinct sections, namely, **Envelope**, **Service**, and **Ultimate**.

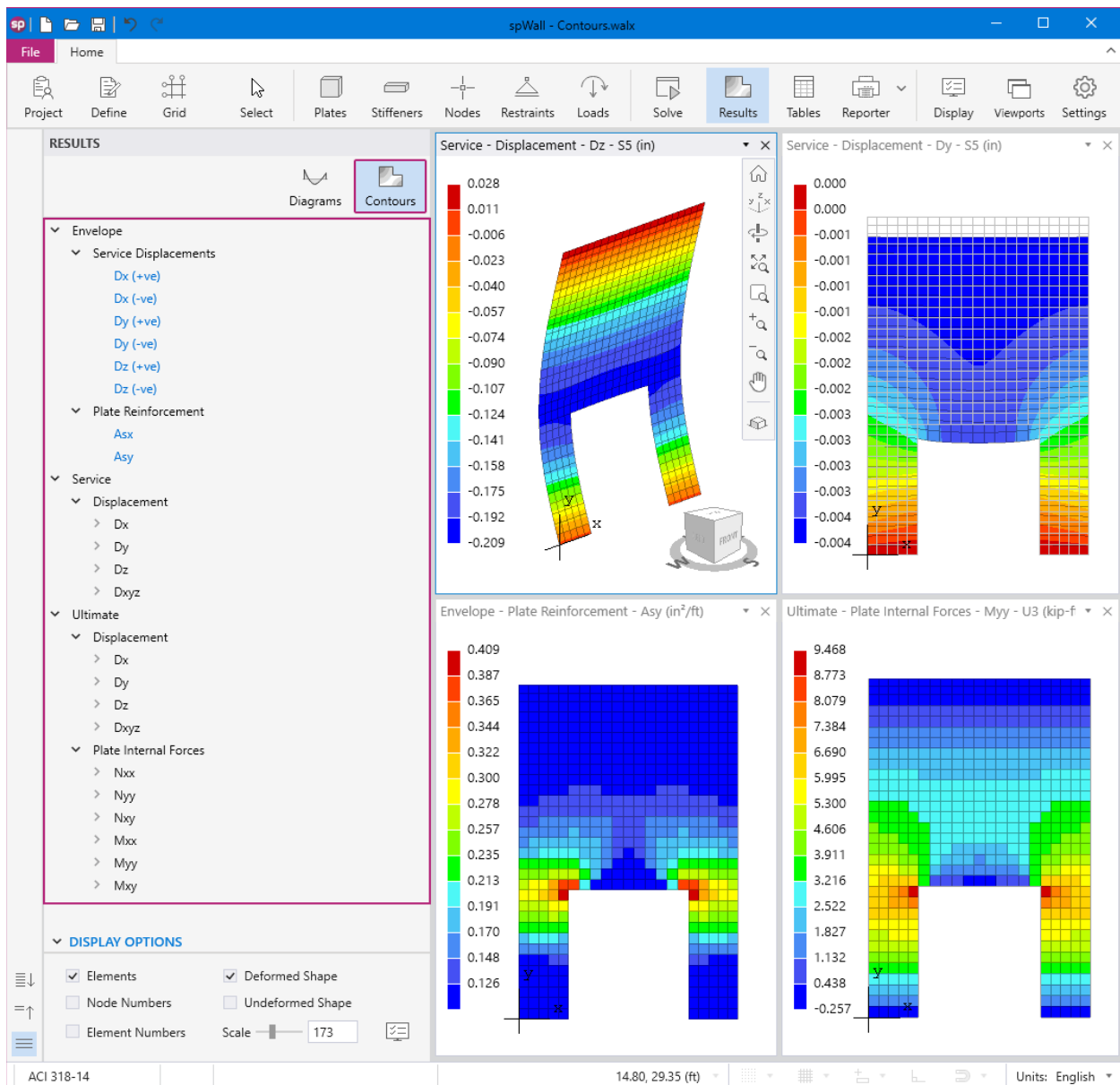

7.2.1.1. Envelope

This section contains the **Envelope** graphical results information on **Service Displacement** and **Plate Reinforcement**.

Service Displacement

This graphical view displays the contour envelopes for the maximum positive (+ve) and maximum negative (-ve) displacements (D_x , D_y , and D_z). Displacement envelopes are calculated from the results of the service load combinations. Displacements are shown in the directions of the global axes.

Plate Reinforcement

This graphical view displays the contour envelopes for the required areas of steel for flexure in the X direction (A_{sx}) and the Y direction (A_{sy}). Half of the displayed value applies to each curtain in models with two curtain layout. When flexure design of some elements fails and the user wants to display a contour map with plate flexural reinforcement, the program will display a warning message indicating that some elements failed flexure design and then the contour map will be shown. Elements that failed the design are marked with a diagonal pattern as illustrated here.

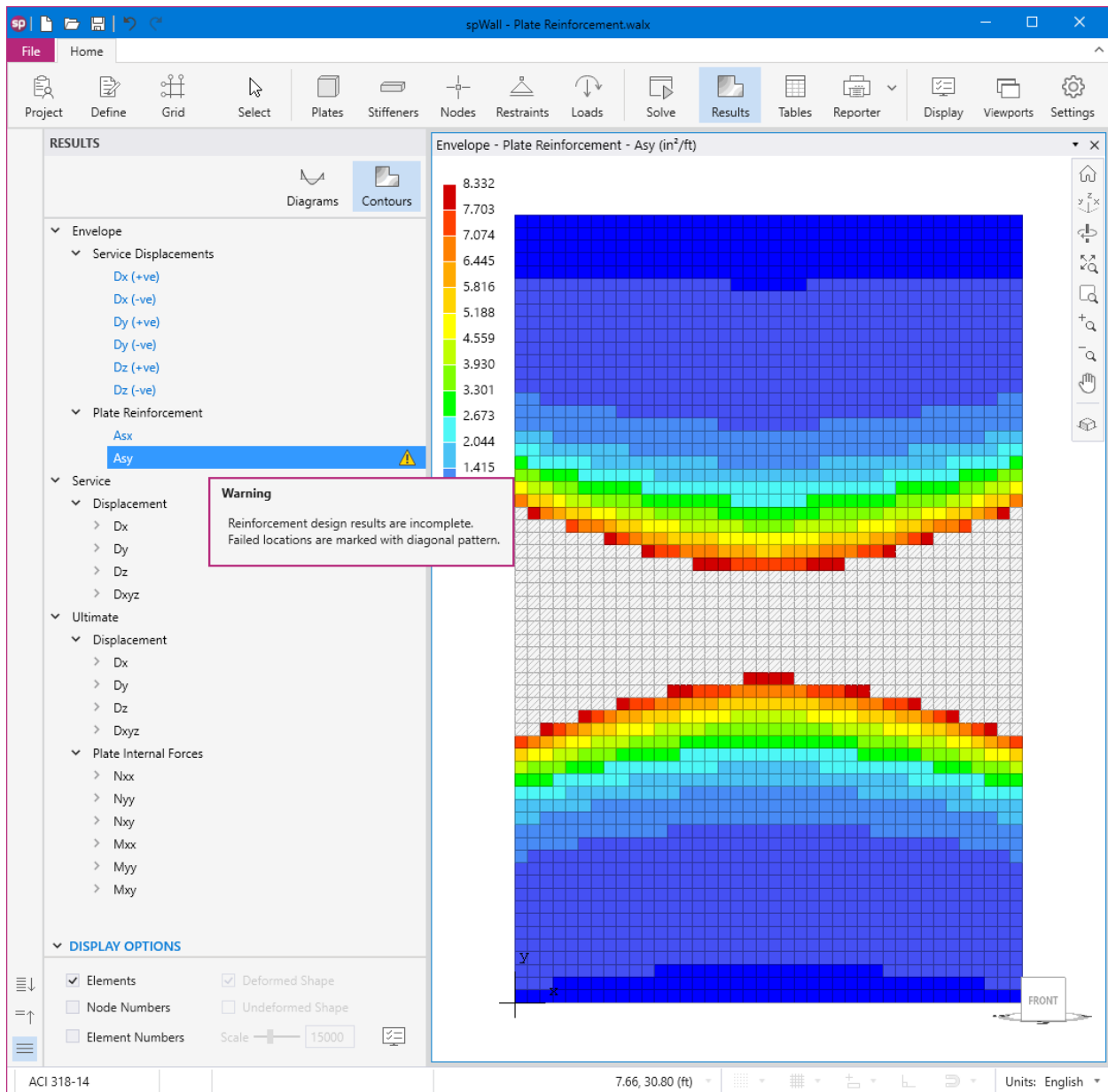

7.2.1.2. Service

This section contains the **Service** level graphical results information on **Displacement**, and **Soil Pressure**.

Displacement

This graphical view displays the displacements (D_x , D_y , D_z , and D_{xyz}) contours for individual service load combinations. Displacements are shown in the directions of the global axes. D_{xyz} displacements contour shows displacements in all 3 directions (i.e., D_x , D_y and D_z) combined in the same contour. This provides a holistic accurate depiction of the actual overall structure deflected shape.

7.2.1.3. Ultimate

This section contains the **Ultimate** level graphical results information on **Displacement** and **Plate Internal Forces**.

Displacement

This graphical view displays the displacements (D_x , D_y , D_z , and D_{xyz}) contours for individual ultimate load combinations. Displacements are shown in the directions of the global axes. D_{xyz} displacements contour shows displacements in all 3 directions (i.e., D_x , D_y and D_z) combined in the same contour. This provides a holistic accurate depiction of the actual overall structure deflected shape.

Plate Internal Forces

This graphical view displays the in-plane forces (N_{xx} , N_{yy} , N_{xy}), the bending moments (M_{xx} , M_{yy}), and the torsional moment (M_{xy}) contours for individual ultimate load combinations. Forces and moments are shown in the directions of the global axes.

7.2.1.4. Contour Display Options

The contours **Display Options** allow the user to control the view of plate elements, plate element numbers, node numbers, deformed shape, undeformed shape, and deformed shape scale. It also contains a shortcut button for **Display** command.

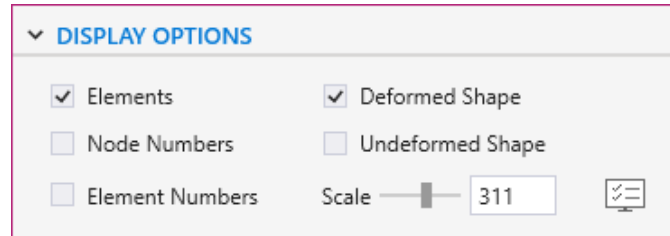

7.2.2. Diagrams

Diagram views are to facilitate the graphical examination of the results by the user. Diagram views show the ultimate level results in three distinct sections, namely, **Stiffener Internal Forces**, **Wall Cross-Sectional Forces**, and **Wall Concrete Shear Strength**.

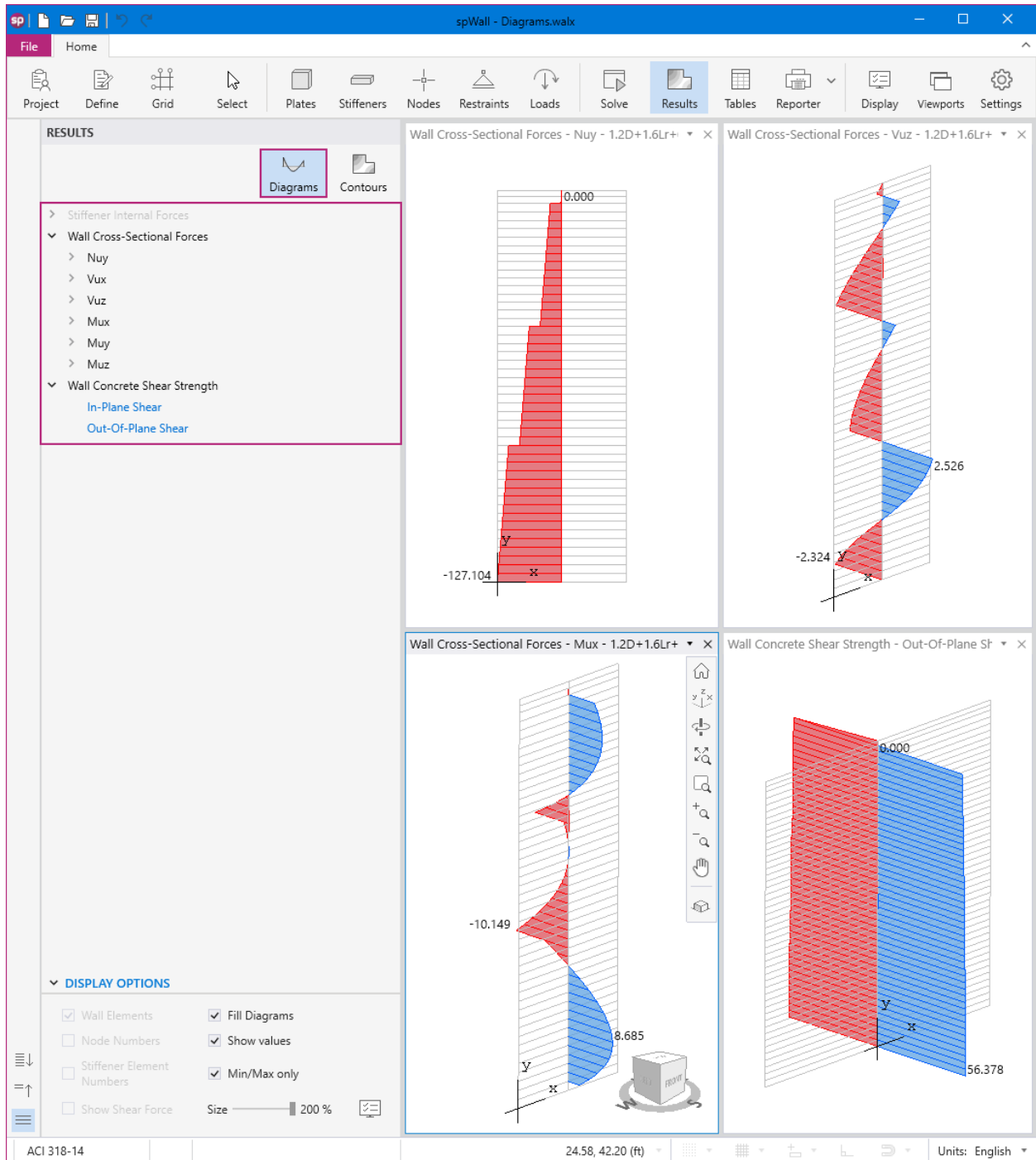

7.2.2.1. Stiffener Internal Forces

This graphical view displays the internal forces (N_x , V_y , and V_z), the internal bending moments (M_y and M_z) and the torsional moment (T_x) diagrams for individual ultimate load combinations. Forces and moments are shown in the directions of the local axes of the stiffener element.

7.2.2.2. Wall Cross-Sectional Forces

This graphical view displays the cross-sectional forces (N_{uy} , V_{ux} , and V_{uz}) and moments (M_{ux} , M_{uy} , and M_{uz}) diagrams for individual ultimate load combinations. Forces and moments are shown in the directions of the global axes.

7.2.2.3. Wall Concrete Shear Strength

This graphical view displays the **In-Plane** and **Out-Of-Plane Wall Concrete Shear Strength**. This portion of results is only available for solid walls designed in accordance with the ACI codes and when the user selects the option to check concrete shear strength.

7.2.2.4. Diagrams Display Options

The diagrams **Display Options** allow the user to control the view of wall elements, stiffener element numbers, node numbers, shear force, fill diagrams, show values, show minimum maximum values only, and diagram size. It also contains a shortcut button for **Display** command.

▼ **DISPLAY OPTIONS**

<input checked="" type="checkbox"/> Wall Elements	<input type="checkbox"/> Fill Diagrams
<input type="checkbox"/> Node Numbers	<input checked="" type="checkbox"/> Show values
<input type="checkbox"/> Stiffener Element Numbers	<input checked="" type="checkbox"/> Min/Max only
<input type="checkbox"/> Show Shear Force	Size <input type="range" value="100"/> 100 % 

7.2.3. Viewing Aids

Viewing aids are those features in the program that facilitate viewing the graphical output results produced by the program.

7.2.3.1. Multiple Viewports

Multiple viewports can be used to view different contours, diagrams, and model views at the same time. The **Viewports** Command in the **Ribbon** can be used to select from a set of pre-defined viewport configurations or create a new viewport window. A maximum of 6 viewports can be used at one time.

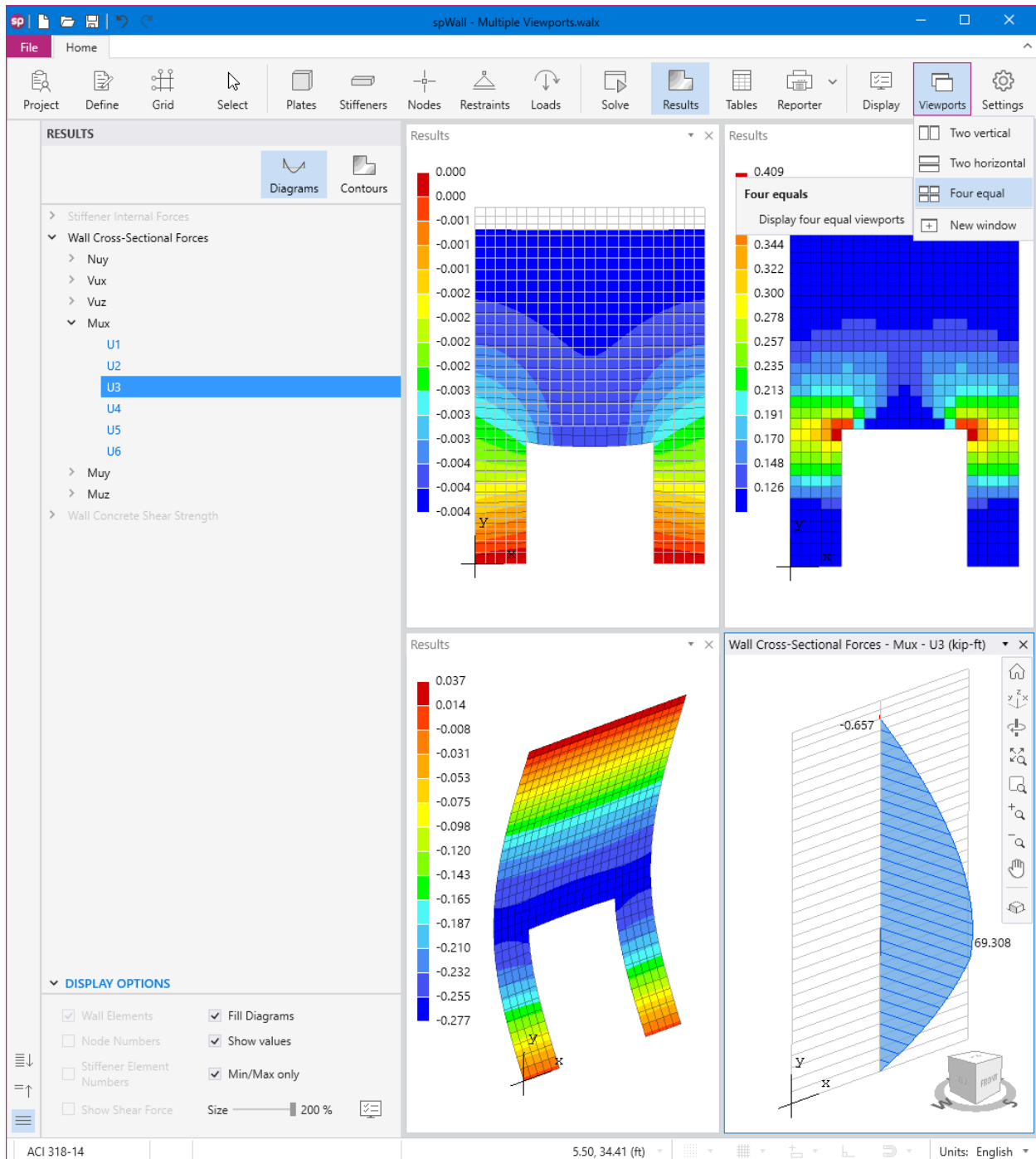

7.2.3.2. View Controls

When a viewport is active it has a set of **View Controls** located in the top right corner. These commands can be used to aid in viewing the model, diagrams, or contours.

Commands in the **View Controls** can be used to VIEW HOME, VIEW 3D, ROTATE, ZOOM TO MODEL, ZOOM TO WINDOW, ZOOM IN, ZOOM OUT, PAN and EXTRUDE.

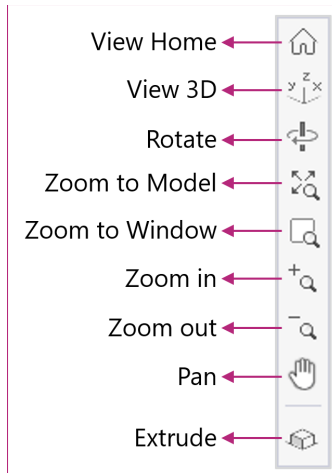

Users can also:

- Rotate Section in 3D: Enables rotating the model, diagram, or contour in three dimensions (shift + middle mouse button)
- Zoom in and zoom out using the mouse wheel and panned by holding the middle mouse button and moving the mouse around.

7.2.3.3. Display Options

The **Display** Command in the **Ribbon** can be used to open the DISPLAY OPTIONS dialog. This dialog facilitates toggling on/off the different Objects, Loads, Restraints, and Grids.

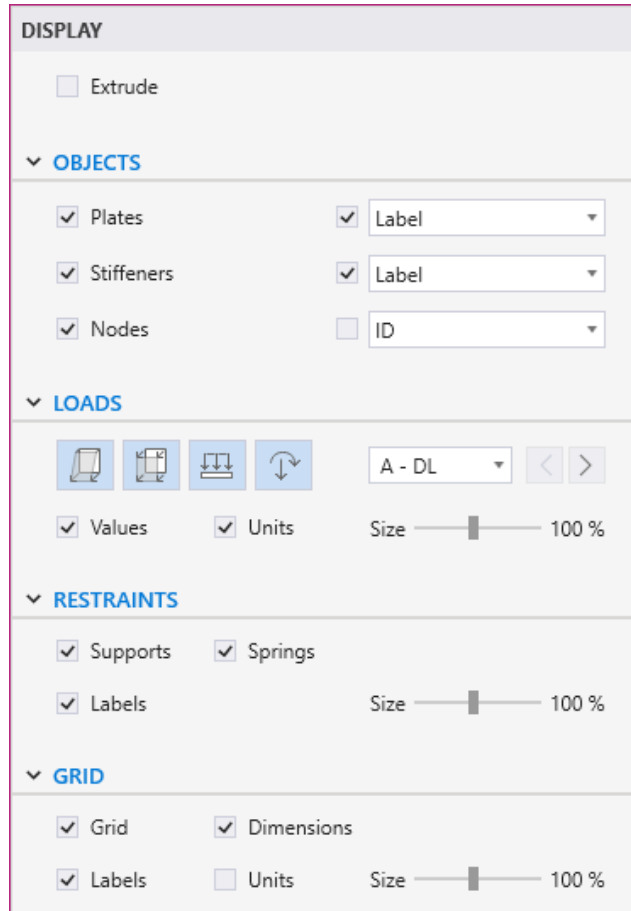

CHAPTER

8

EXAMPLES

- 8.1. Example 1 - Load Bearing Wall..... 232
 - 8.1.1. Problem Formulation..... 232
 - 8.1.2. Preparing the Input 234
 - 8.1.3. Assigning Properties..... 248
 - 8.1.4. Assigning Supports..... 249
 - 8.1.5. Assigning Loads 253
 - 8.1.6. Solving..... 257
 - 8.1.7. Viewing and Printing Results..... 260
- 8.2. Example 2 - Cantilever Retaining Wall 266
 - 8.2.1. Problem Information 266
 - 8.2.2. Preparing the Input 268
 - 8.2.3. Assigning Properties..... 282
 - 8.2.4. Assigning Supports..... 285
 - 8.2.5. Assigning Loads 287
 - 8.2.6. Solving..... 290
 - 8.2.7. Viewing and Printing Results..... 293

8.1. Example 1 - Load Bearing Wall

8.1.1. Problem Formulation

This example will illustrate the analysis and design of the wall shown below. As is required for typical precast or tilt-up load bearing panels, a second order analysis will be performed.

Design data

$$f_c' = 4,000 \text{ psi}$$

$$w_c = 150 \text{ pcf}$$

$$\nu \text{ (Poisson's ratio)} = 0.20$$

$$f_y = 60,000 \text{ psi}$$

$$E_s = 29,000 \text{ ksi}$$

$$\text{Wall thickness} = 8.75 \text{ in.}$$

$$\text{Eccentricity (e)} = 7.50 \text{ in.}$$

$$\text{Roof dead load} = 0.40 \text{ klf (line load)}$$

$$\text{Roof live load} = 0.50 \text{ klf (line load)}$$

$$\text{Wind load} = 30.0 \text{ psf (uniform area load)}$$

Reinforcement for this wall is considered as two curtains, each composed of two layers: one horizontal with 1 in. cover, and one vertical with 1.5 in. cover.

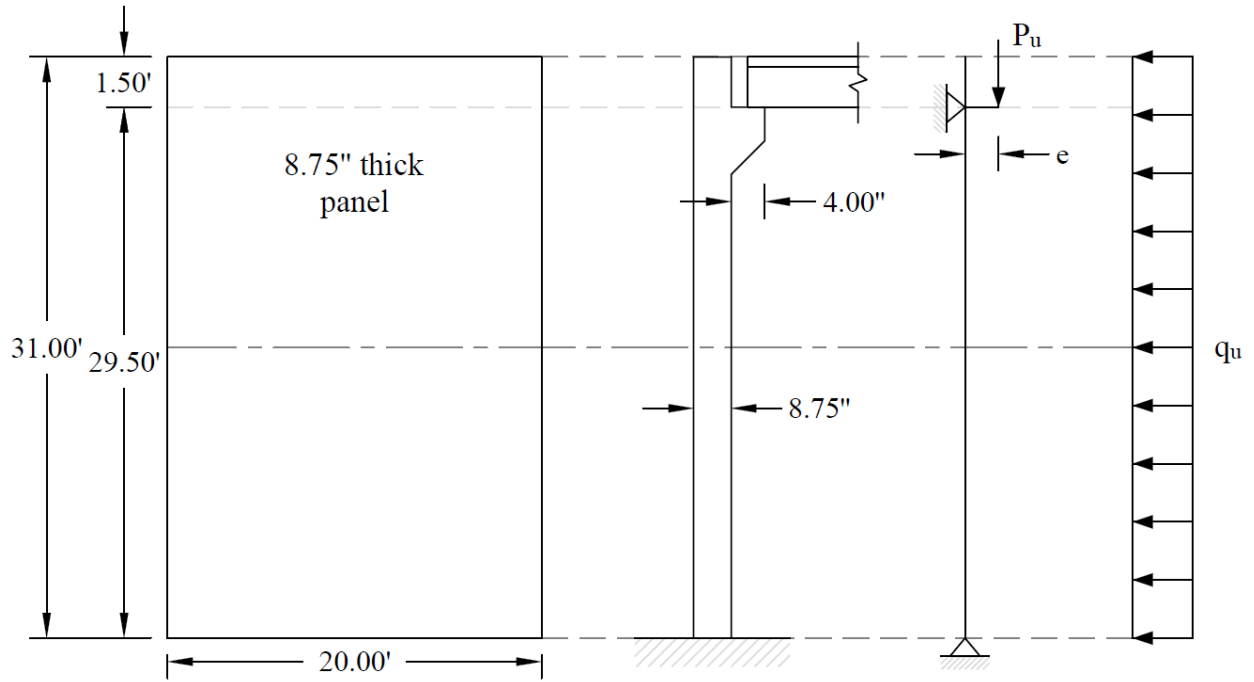
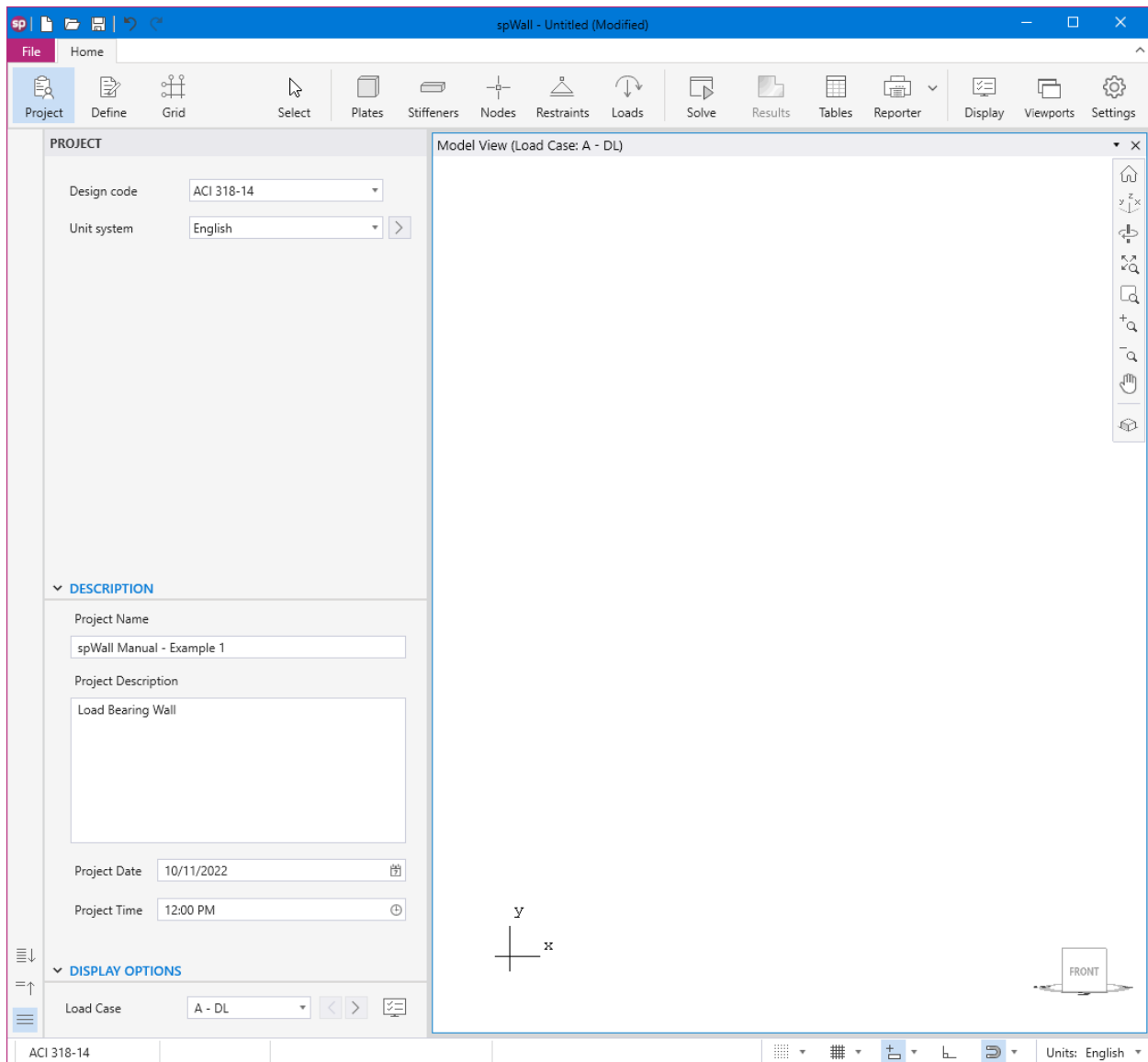

Figure 8.1 – Concrete Wall Geometry

8.1.2. Preparing the Input

1. From the Start screen, select **New Project**.
2. In the **Main Program Window**, select **Project** from the **Ribbon**.
 - Select the DESIGN CODE, UNIT SYSTEM, and enter the PROJECT NAME and PROJECT DESCRIPTION.



3. From the **Ribbon**, select **Grid**.

- Click on the **Generate** in the left panel to have the program surface the following:

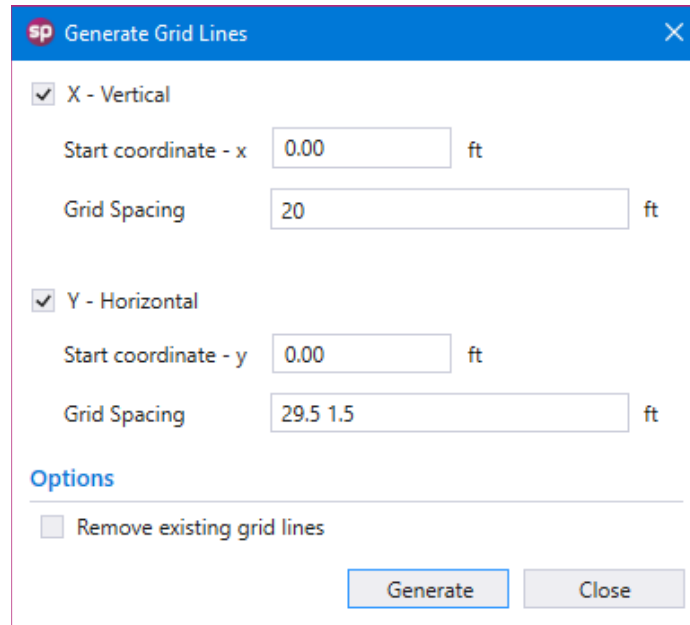

- Place a check mark in the X - VERTICAL box and enter the following values in the corresponding text boxes:

START COORDINATE - X: 0 . 0

GRID SPACING: 20 . 0

- Place a check mark in the Y - VERTICAL box and enter the following values in the corresponding text boxes:

START COORDINATE - Y: 0 . 0

GRID SPACING: 29 . 5 1 . 5

- Click on the GENERATE button to return to the main window. Notice how the VERTICAL and HORIZONTAL grid lines now appear in the VIEWPORT.

spWall - Untitled (Modified)

File Home

Project Define Grid Select Plates Stiffeners Nodes Restraints Loads Solve Results Tables Reporter Display Viewports Settings

GRIDS

Add-H Add-V Generate

VERTICAL

Label	Coordinate-X	Spacing
	ft	ft
A	0.00	0.00
B	20.00	20.00

HORIZONTAL

Label	Coordinate-Y	Spacing
	ft	ft
0	0.00	0.00
1	29.50	29.50
2	31.00	1.50

DISPLAY OPTIONS

Labels Units

Dimensions Size 100%

Model View (Load Case: A - DL)

20.00 ft

31.00 ft

29.50 ft

1.50 ft

A B

2 1

0

x y

FRONT

ACI 318-14 20.01, 36.14 (ft) Units: English

4. From the **Ribbon**, select **Define**, then choose **Plates** from **Objects** to display the **Plates** dialog box.

- Input Plate-A for LABEL and 8.75 in. for THICKNESS.
- Click on the APPLY button to apply the changes.

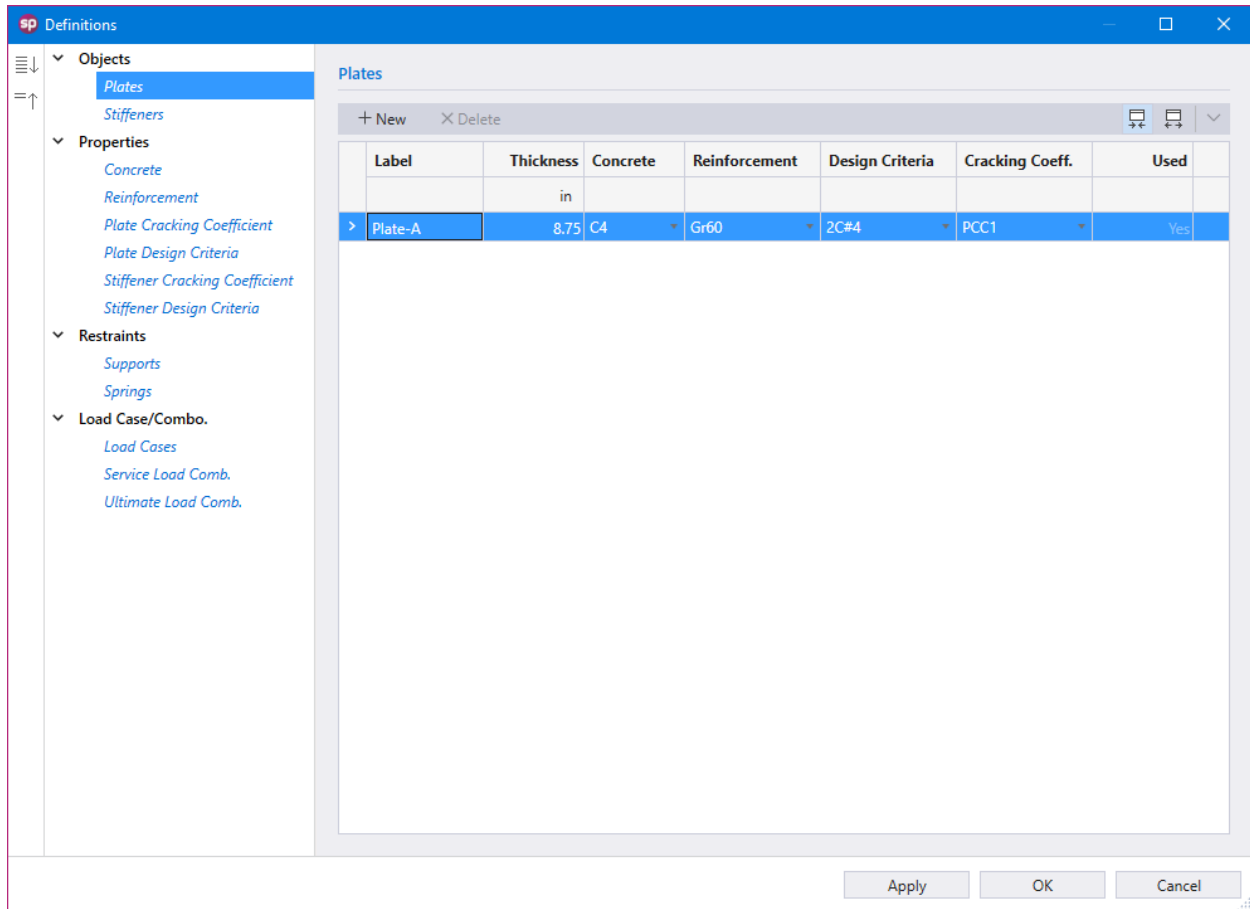

5. Click on **Concrete** from **Properties** to display the **Concrete** dialog box.

- Enter the following:

LABEL: C4

UNIT WEIGHT: 150 pcf

COMPRESSIVE STRENGTH: 4 ksi

YOUNG’S MODULUS: 3834 . 30 ksi

POISSON’S RATIO: 0 . 20

- Click on the APPLY button to apply the changes.

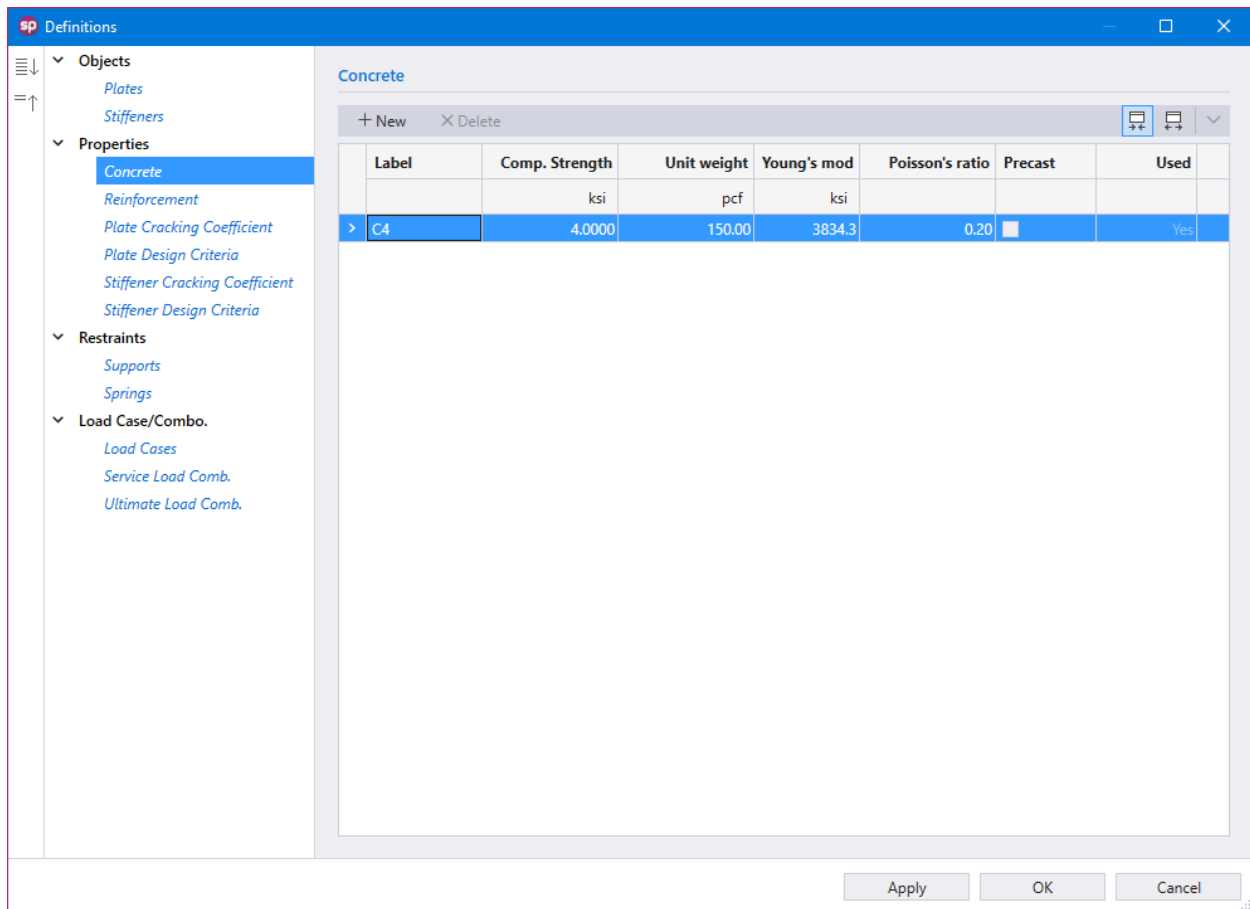

6. Click on **Reinforcement** from **Properties** to display the **Reinforcement** dialog box.

- Enter the following:

LABEL: Gr60

YIELD STRENGTH: 60 ksi

YOUNG'S MODULUS: 29000 ksi

- Click on the APPLY button to apply the changes.

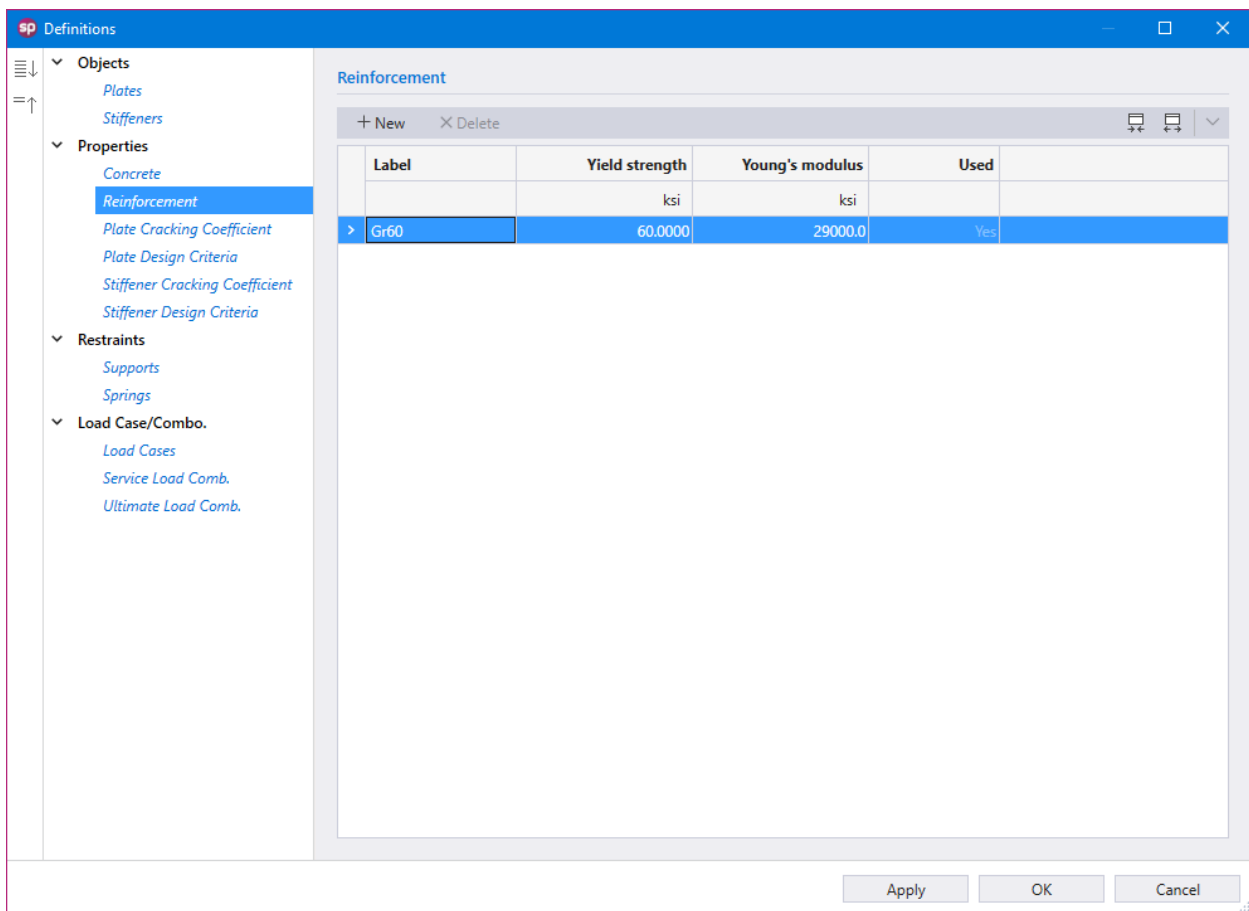

7. Click on **Plate Cracking Coefficient** from **Properties** to display the **Plate Cracking Coefficient** dialog box.

- Enter the following:

LABEL: PCC1

Service Combinations:

IN-PLANE: 1.00

OUT-OF-PLANE: 0.70

Ultimate Combinations:

IN-PLANE: 1.00

OUT-OF-PLANE: 0.35

- Click on the **APPLY** button to apply the changes.

Definitions

- Objects
 - Plates
 - Stiffeners
- Properties
 - Concrete
 - Reinforcement
 - Plate Cracking Coefficient**
 - Plate Design Criteria
 - Stiffener Cracking Coefficient
 - Stiffener Design Criteria
- Restraints
 - Supports
 - Springs
- Load Case/Combo.
 - Load Cases
 - Service Load Comb.
 - Ultimate Load Comb.

Plate Cracking Coefficient

+ New X Delete

Label	Service Combinations		Ultimate Combinations		Used
	In-plane	Out-of-plane	In-plane	Out-of-plane	
> PCC1	1.00	0.70	1.00	0.35	Yes

Apply OK Cancel

8. Click on **Plate Design Criteria** from **Properties** to display the **Plate Design Criteria** dialog box.

- Enter the following:

LABEL:	2C#4
REINFORCEMENT LAYOUT:	Two Curtains
REINFORCEMENT RATIO:	
HORIZONTAL MIN.:	0.20 %
HORIZONTAL MAX.:	8.00 %
VERTICAL MIN.:	0.12 %
VERTICAL MAX.:	8.00 %
REINFORCEMENT LOCATION:	
BACK CURTAIN HOR. (BH):	1.00 in.
BACK CURTAIN VER. (BV):	1.50 in.
FRONT CURTAIN HOR. (FH):	1.00 in.
FRONT CURTAIN VER. (FV):	1.50 in.

- Click on the **APPLY** button to apply the changes.

Definitions
□
✕

Objects

- Plates
- Stiffeners

Properties

- Concrete
- Reinforcement
- Plate Cracking Coefficient
- Plate Design Criteria
- Stiffener Cracking Coefficient
- Stiffener Design Criteria

Restraints

- Supports
- Springs

Load Case/Combo.

- Load Cases
- Service Load Comb.
- Ultimate Load Comb.

Plate Design Criteria

Label:

Reinf. Layout:

Allow one curtain in walls thicker than 10 in.

Reinforcement Ratio

Horizontal Min. %

Horizontal Max. %

Vertical Min. %

Vertical Max. %

Allow minimum below code

Reinforcement Location

Back Curtain Hor. (BH) in

Back Curtain Vert. (BV) in

Front Curtain Hor. (FH) in

Front Curtain Vert. (FV) in

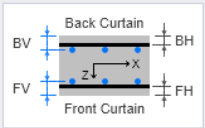

+ New ✕ Delete

Label	Reinf. L.	One Cu	Rmin (l)	Rmax (l)	Rmin (t)	Rmax (t)	Min. belo	Back H.	Back V.	Front H.	Front V.	Used
> 2C#4	Two C	■	0.20	8.00	0.12	8.00	■	1.00	1.50	1.00	1.50	Yes

9. Click on **Supports** from **Restraints** to display the **Supports** dialog box.

- Enter the following:

LABEL: Hinged

Select the following restraints to model simply supported end conditions: D_x , D_y , D_z

LABEL: Lateral

Select the following restraints to model roller end conditions: D_z

- Click on the APPLY button to apply the changes.

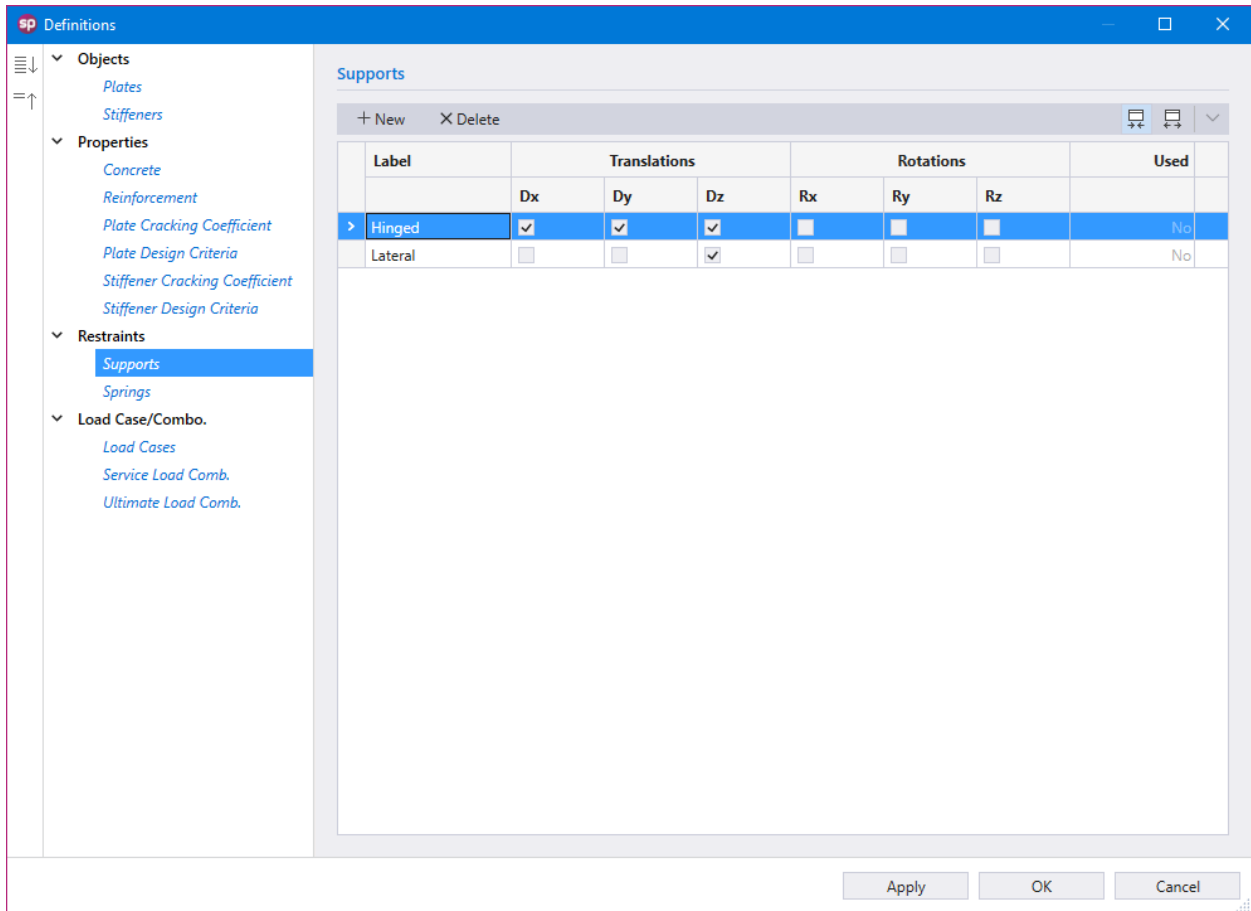

11. Click on **Service Load Combinations** from **Load Case/Combo.** to display the **Service Load Combinations** dialog box.

- Enter the following service load combinations shown in the figure below:

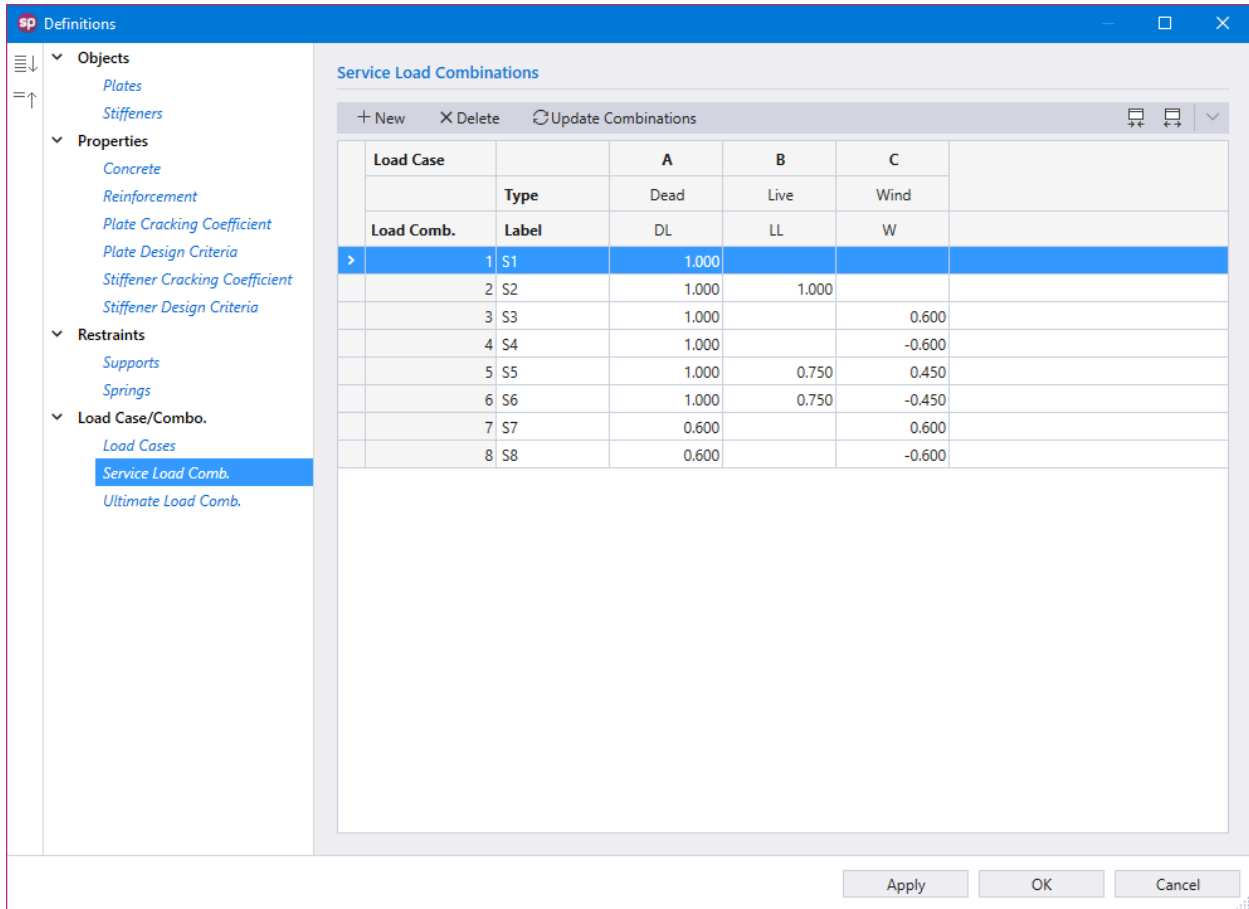

12. Click on **Ultimate Load Combinations** from **Load Case/Combo.** to display the **Ultimate Load Combinations** dialog box.

- Enter the following load combinations shown in the figure below:

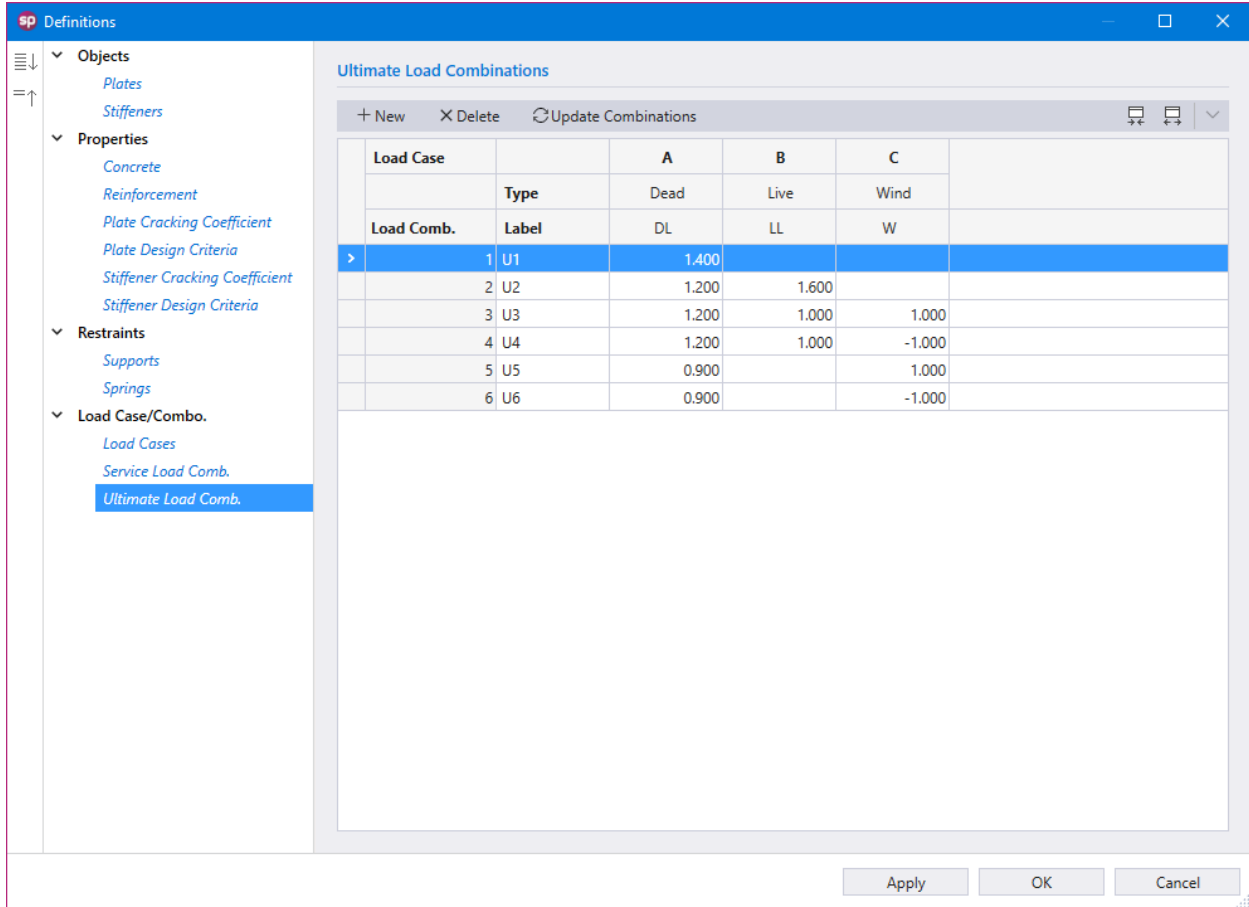

8.1.3. Assigning Properties

13. From the **Ribbon**, select **Plates** command.

- In the left panel, select **Rectangle** then select PLATE-A from LABEL.
- In the VIEWPORT, marquee-select the region (A, 0) – (B, 2) to apply the selected plate to the entire wall.

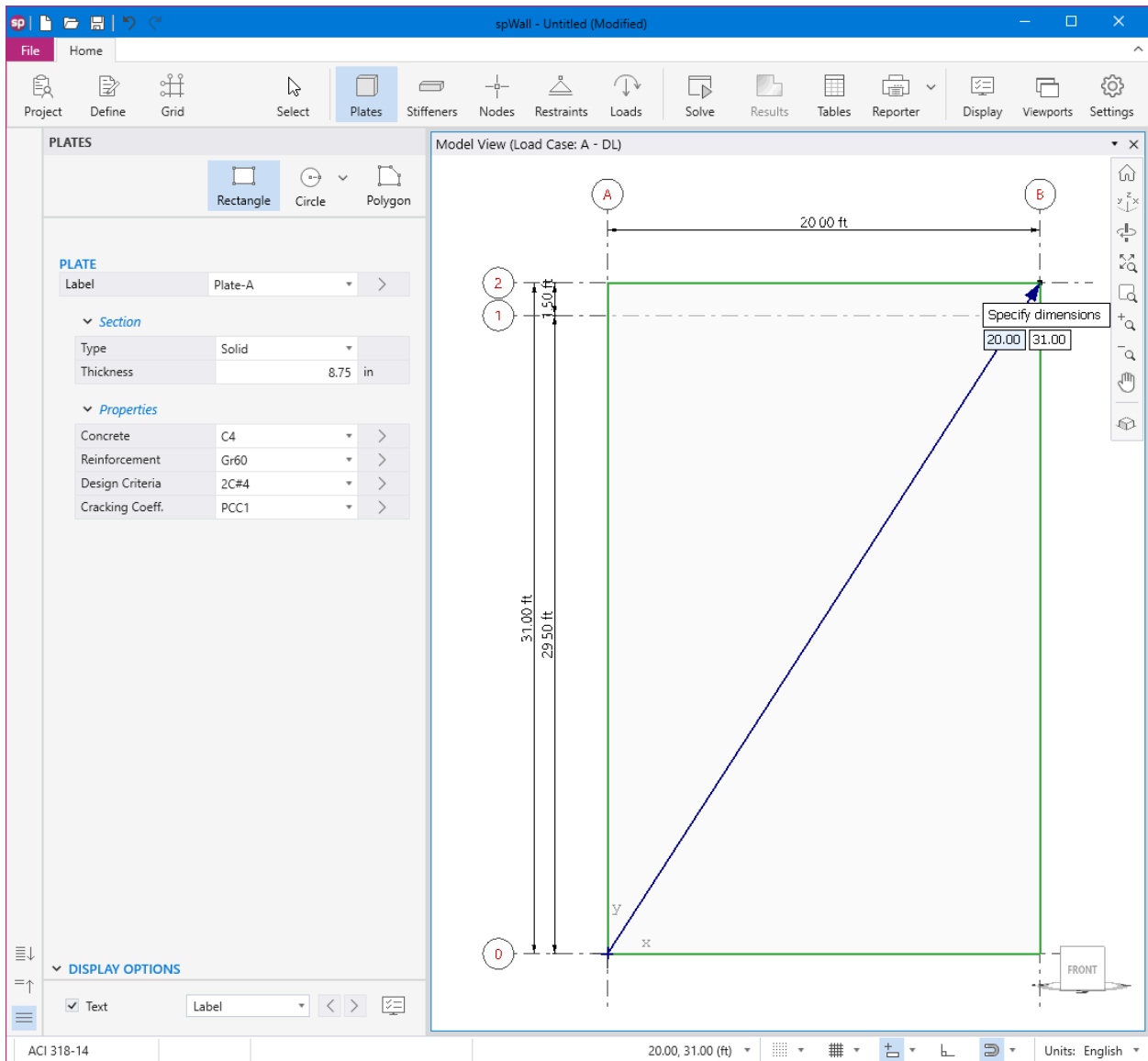

8.1.4. Assigning Supports

14. From the **Ribbon**, select **Stiffeners** command.

- In the left panel, select **Null**.
- Apply at the bottom of the wall as shown in the figure below.

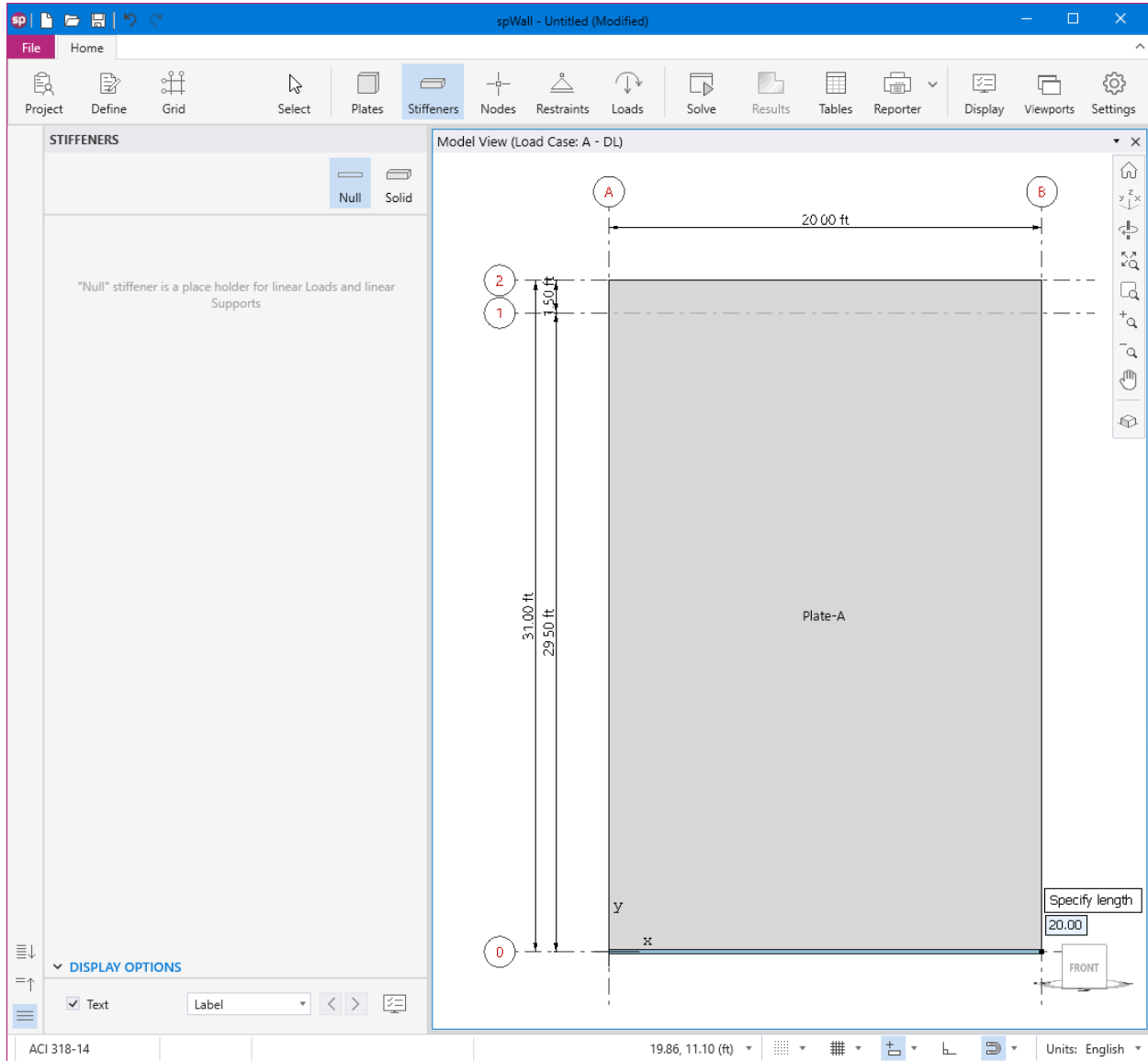

- Apply also on Axis 1 as shown in the figure below.

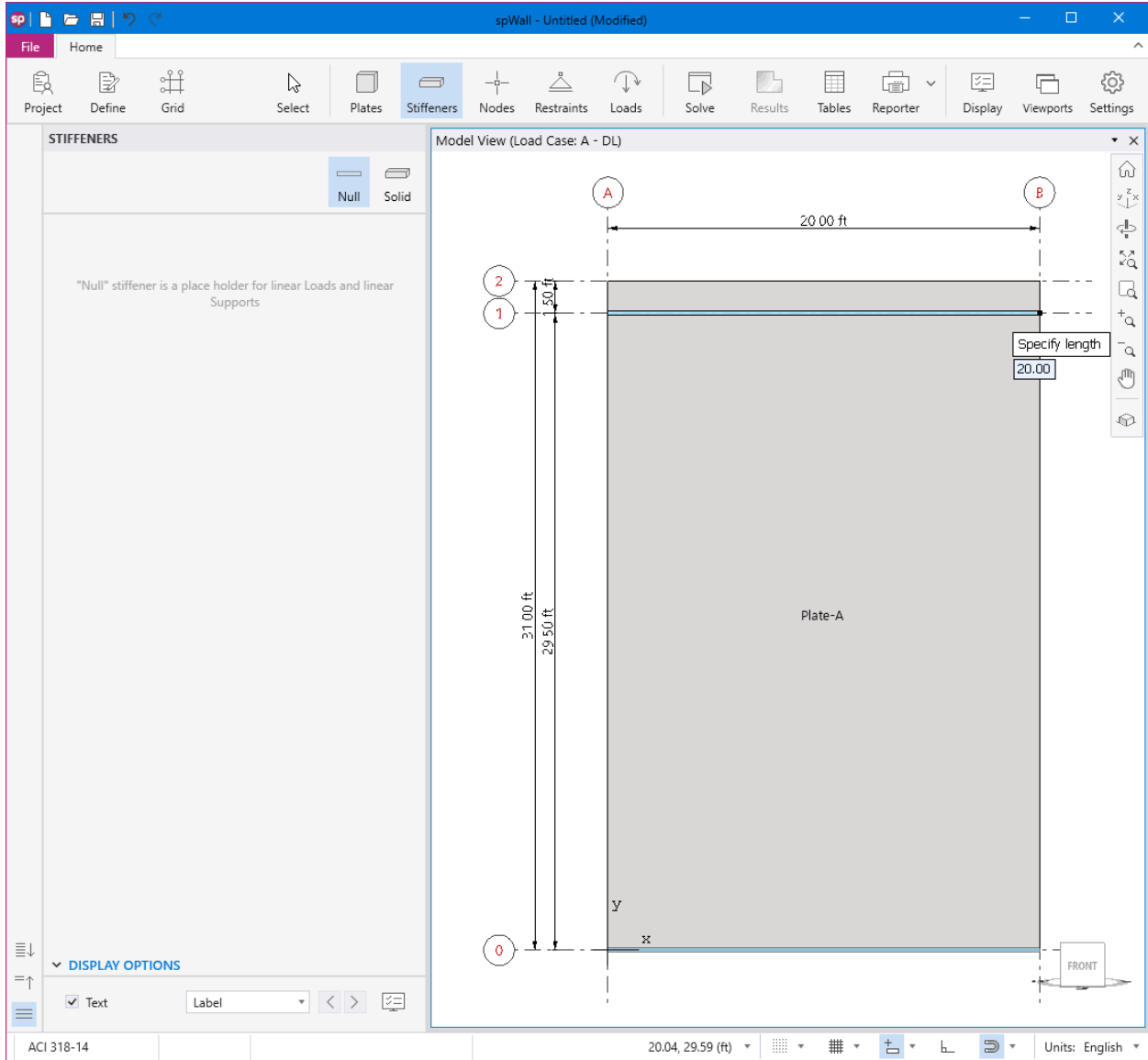

15. From the **Ribbon**, select **Restraints** command.

- In the left panel, select **Linear** then select HINGED from LABEL.
- Apply HINGED support to the bottom null stiffener as shown in the figure below.

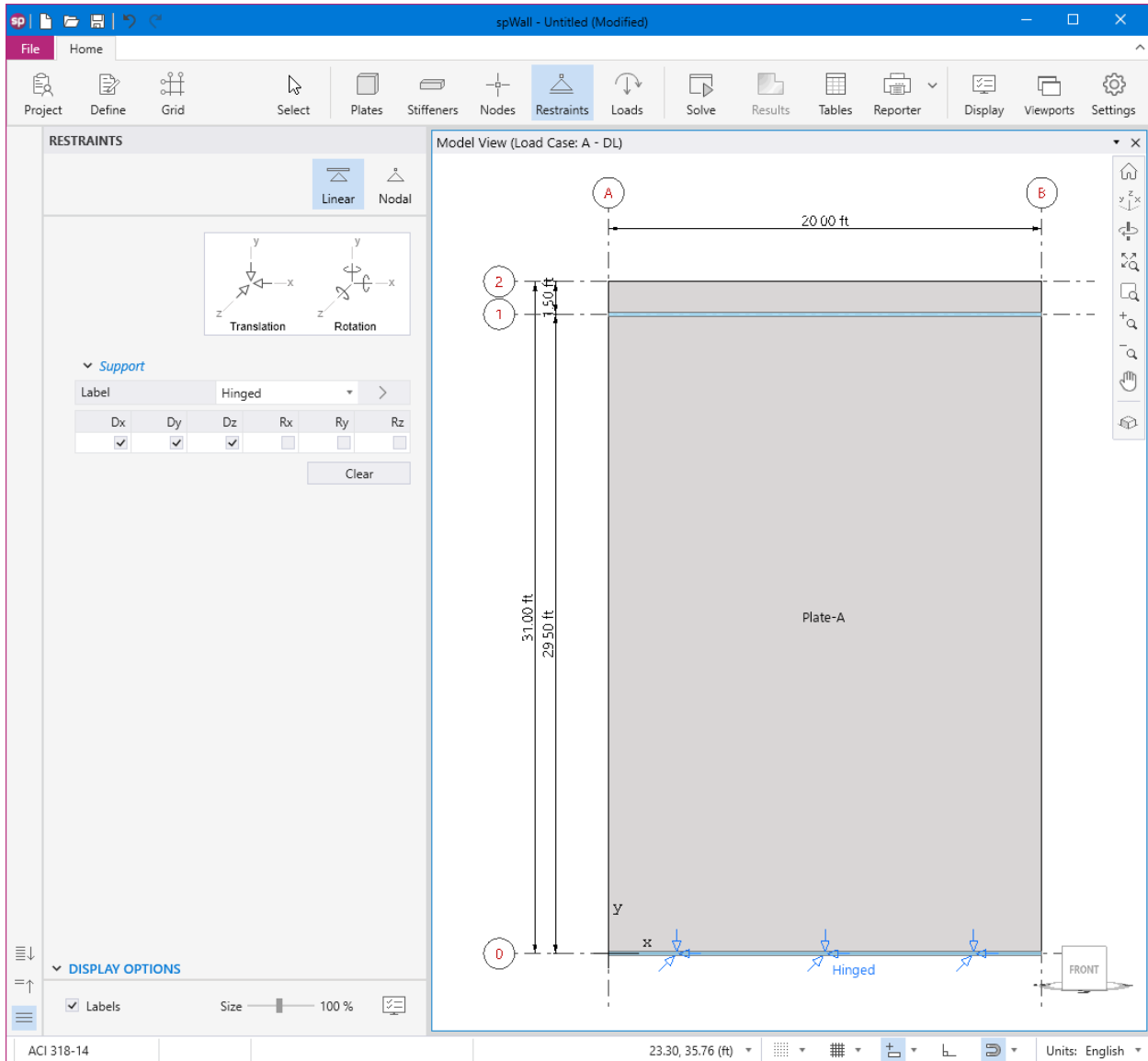

- Select LATERAL from LABEL.
- Apply LATERAL support to the top null stiffener as shown in the figure below.

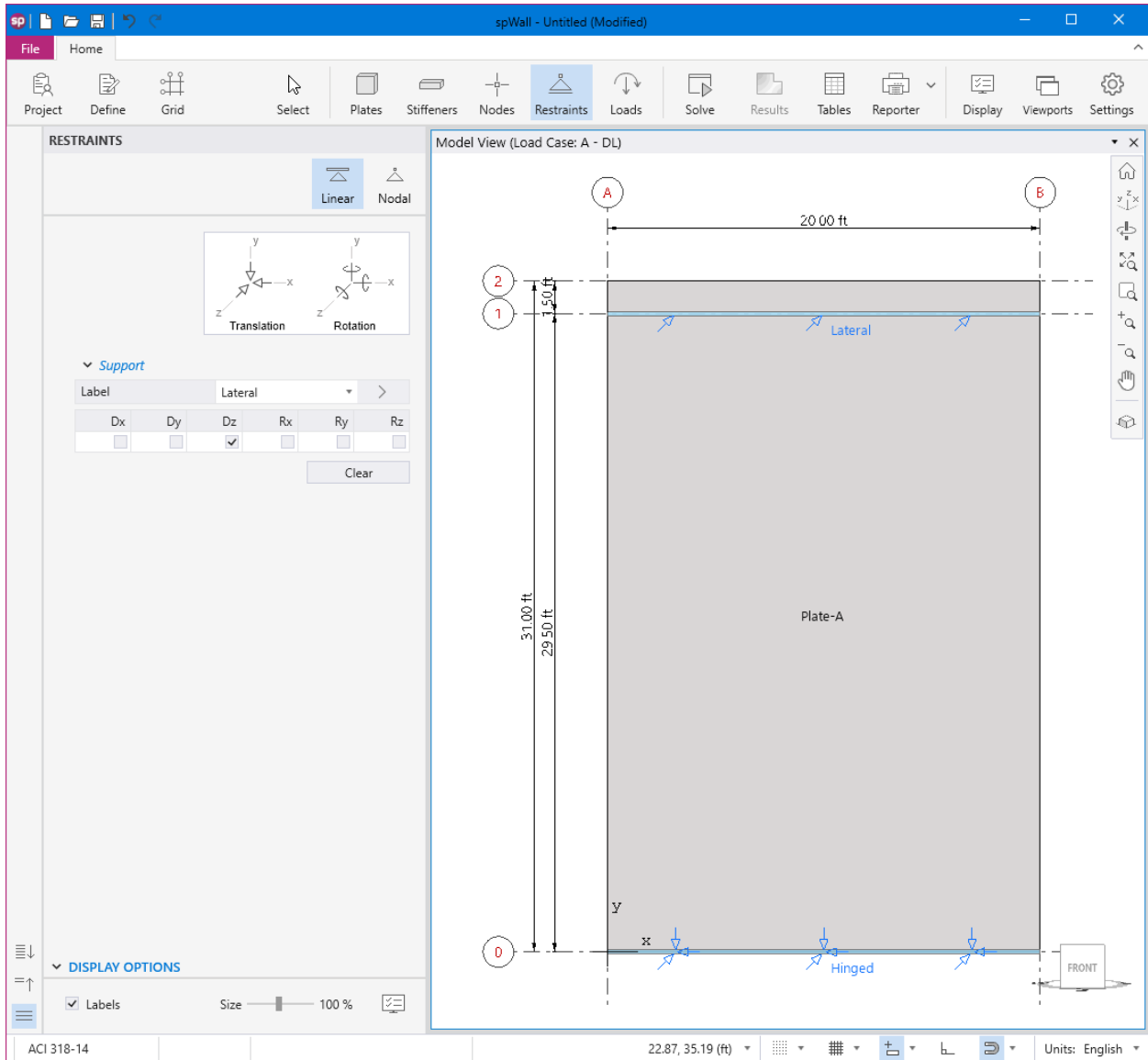

8.1.5. Assigning Loads

16. From the **Ribbon**, select **Loads** command.

- In the left panel, select **Uniform Line** then select A-DL from LOAD CASE and enter the following:

W_Y: -0.40 klf

ECCENTRICITY: 7.50 in.

- Apply to the top null stiffener as shown in the figure below.

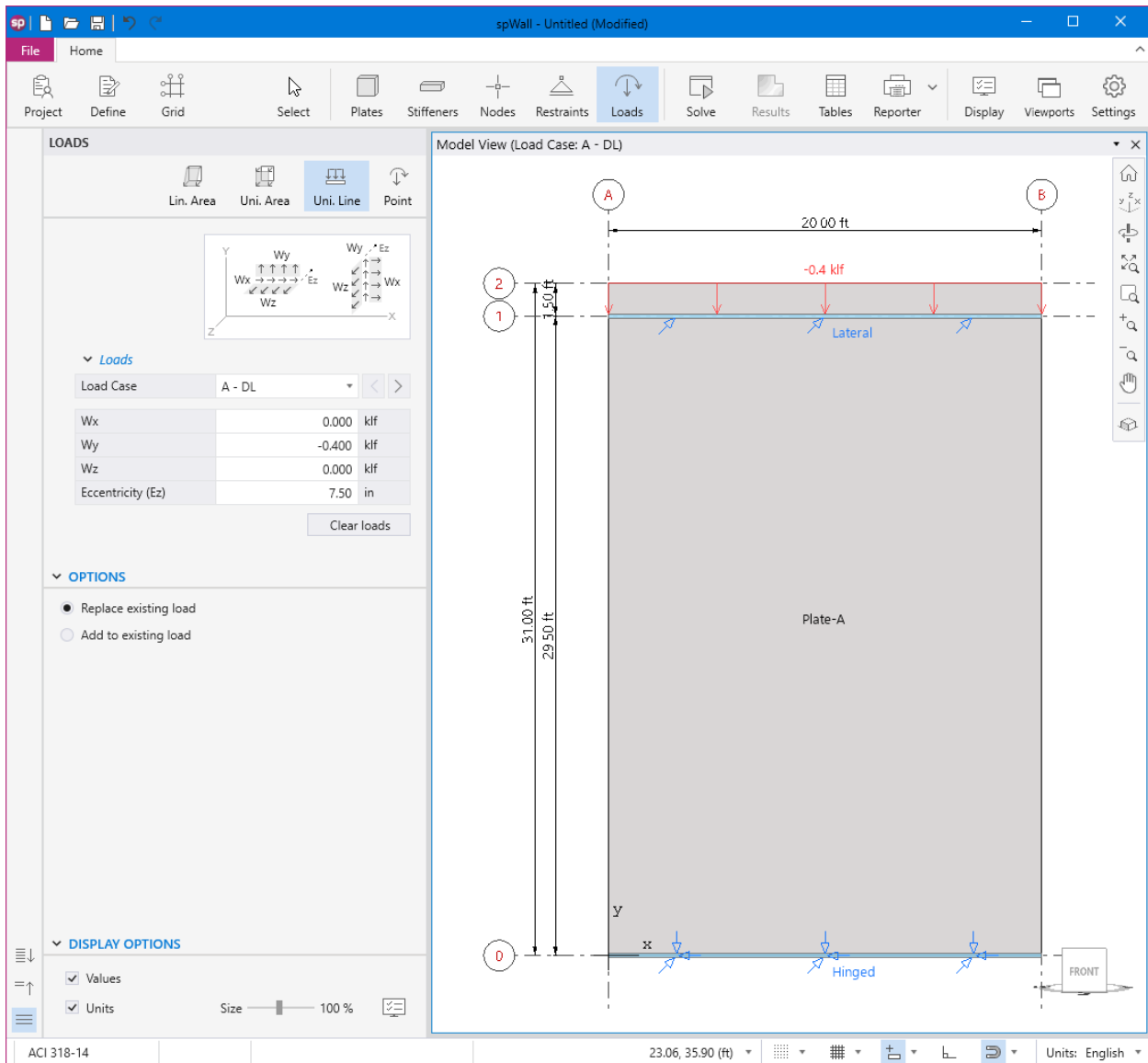

- Select B-LL from LOAD CASE and enter the following:

W_Y: -0.50 klf

ECCENTRICITY: 7.50 in.

- Apply to the top null stiffener as shown in the figure below.

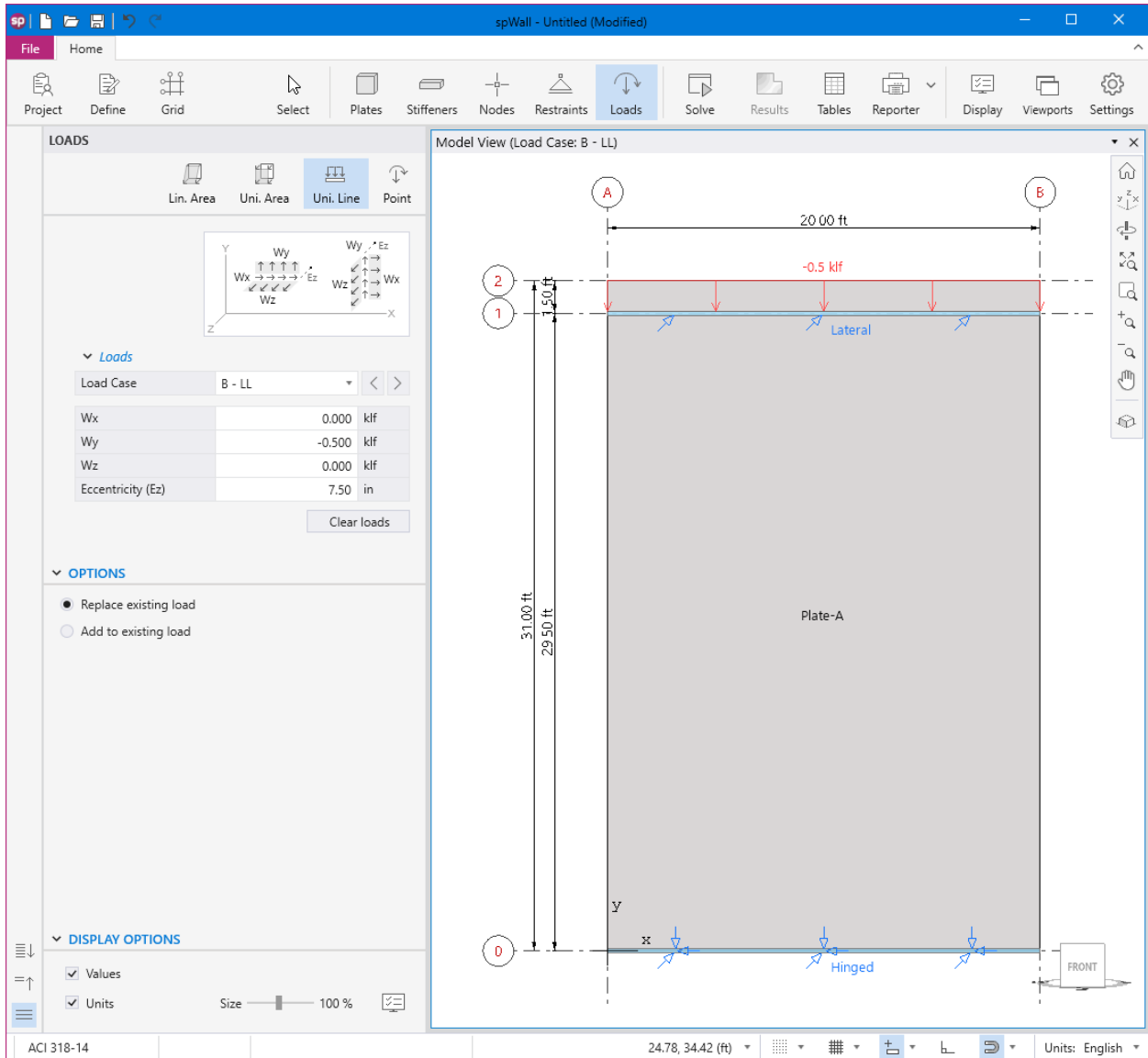

- In the left panel, select **Uniform Area** then select C-W from LOAD CASE and enter the following:

Wz: -30.00 psf

- Apply to the entire wall as shown in the figure below.

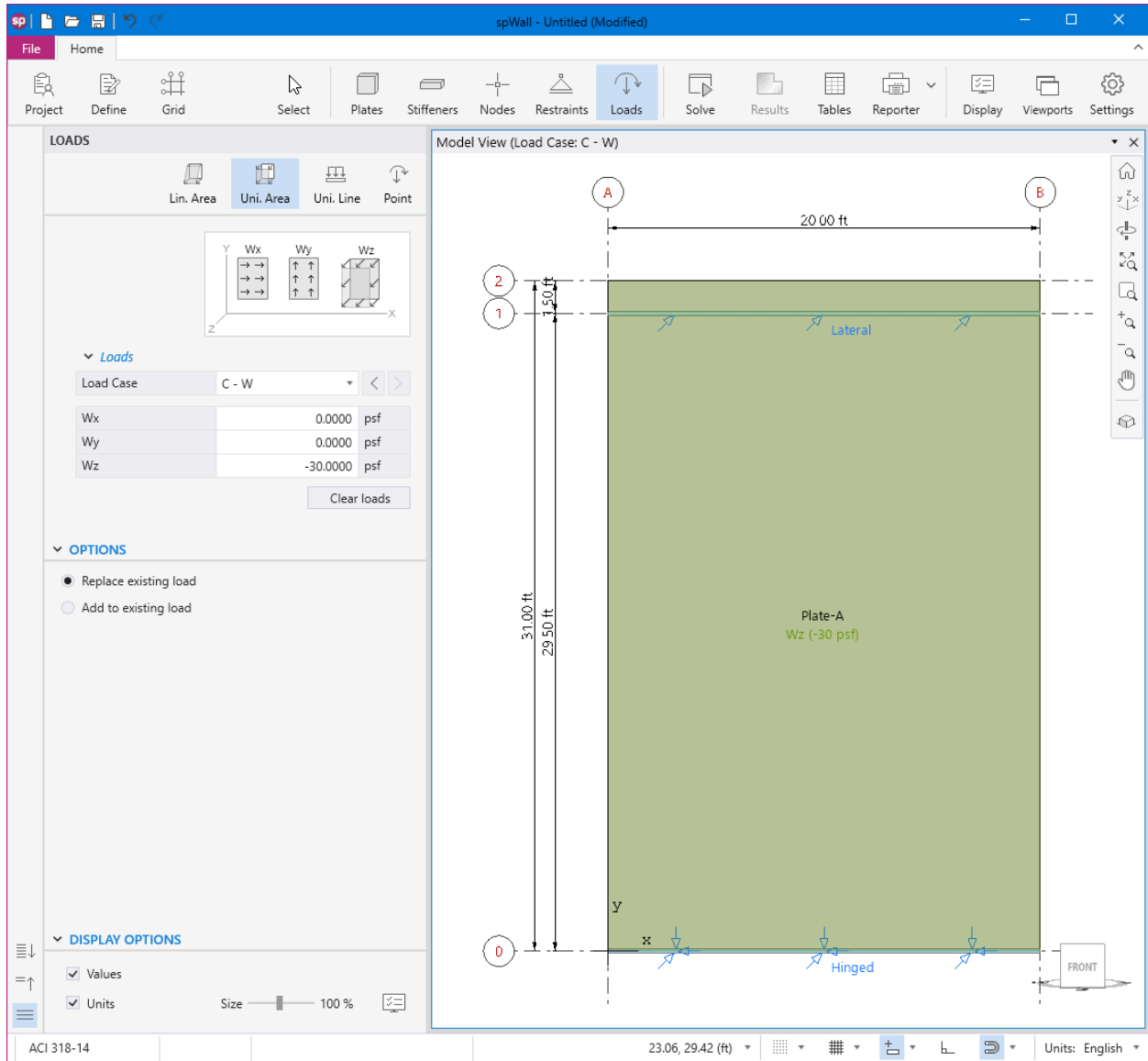

- Also, you can click on the 3D VIEW icon from **View Controls** (top right of the active viewport) to get a better view of the applied loads.

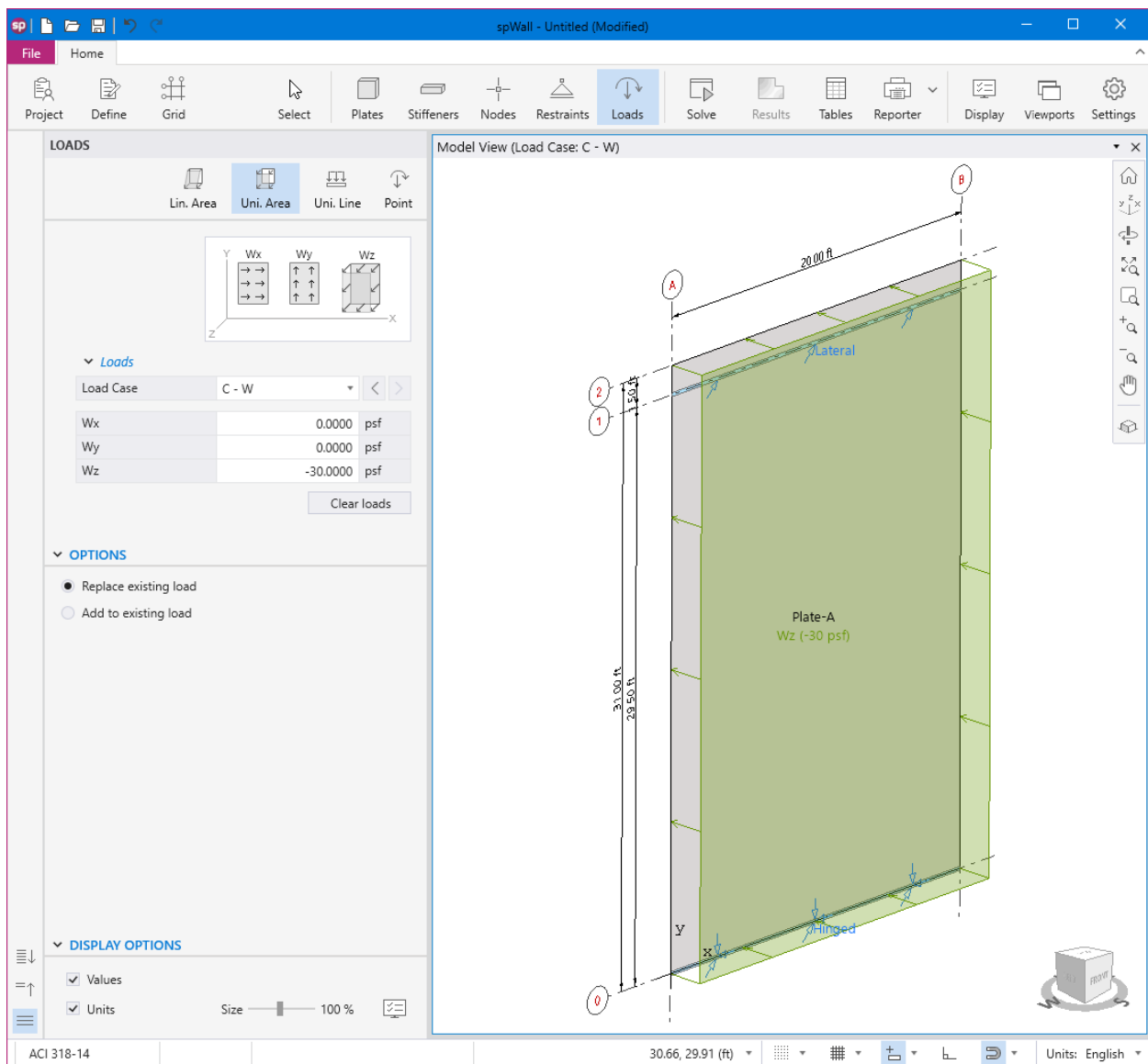

8.1.6. Solving

17. From the **Ribbon**, select **Solve** command.

For **Solve Options**:

- Select ANALYSIS & DESIGN for RUN OPTIONS.
- Select YES for INCLUDED SECOND ORDER EFFECTS.
- Select DISABLE for MAXIMUM ALLOWED OUT-OF-PLANE DEFLECTION.

For **Mesh Options**:

- Enter 1 . 00 ft for the MAXIMUM ALLOWED MESH SIZE.

spWall - Untitled (Modified)

File Home

Project Define Grid Select Plates Stiffeners Nodes Restraints Loads Solve Results Tables Reporter Display Viewports Settings

SOLVE

Run

SOLVE OPTIONS

Run Options	Analysis & Design
Include 2nd Order Effects	Yes
Max. allowed Out-of-Plane Deflection	Disable
User Defined allowed Deflection	279.40000 in

Check Concrete Shear Strength of Wall Crosssections (ACI with Solid walls only)

Use Simplified Equations

Use Detailed Equations (uniform walls only)

MESH OPTIONS

Max. allowed mesh size	1.00 ft
Max. allowed aspect ratio	10
Circle segments	36

Status

Number of elements	640
Min. element size	0.75 ft
Max. element size	1.00 ft
Max. aspect ratio	1.33

DISPLAY OPTIONS

Wall Element Numbers Node Numbers

Stiffener Element Numbers

Solve (Mesh)

20.00 ft

31.00 ft

1.50 ft

29.50 ft

A B

1 2

D

FRONT

ACI 318-14

Units: English

- Click on the **Run** button.
- The spWall **Solver** window is displayed and the solver messages are listed. After the solution is done, the design will be performed and then the focus will immediately be passed to the **Results** scope.

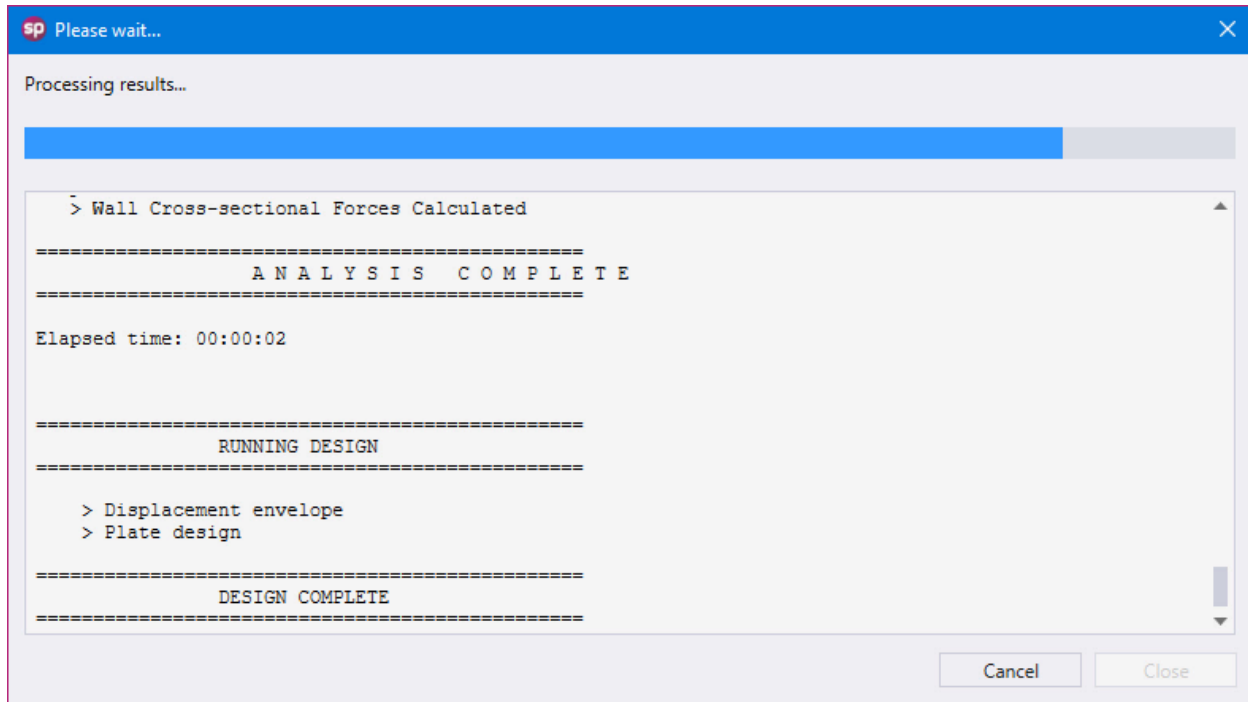

8.1.7. Viewing and Printing Results

- After a successful run, results can be viewed in a contour form by selecting **Contours** from the left panel.

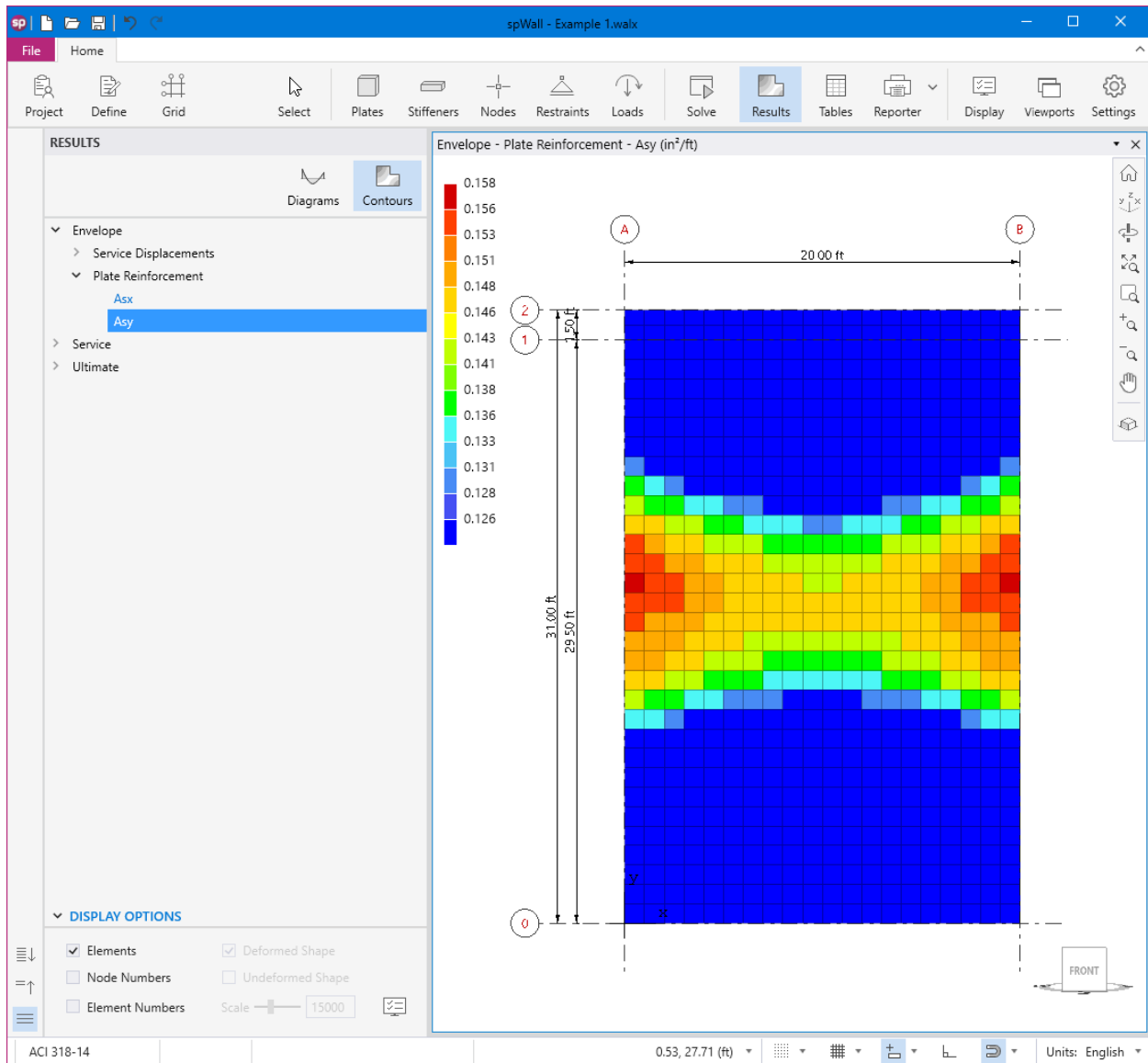

Please be advised that spWall displays the total flexure reinforcement, for each element, for two curtains of reinforcement.

19. Results can be viewed in a force diagram form by selecting **Diagrams** from the left panel.

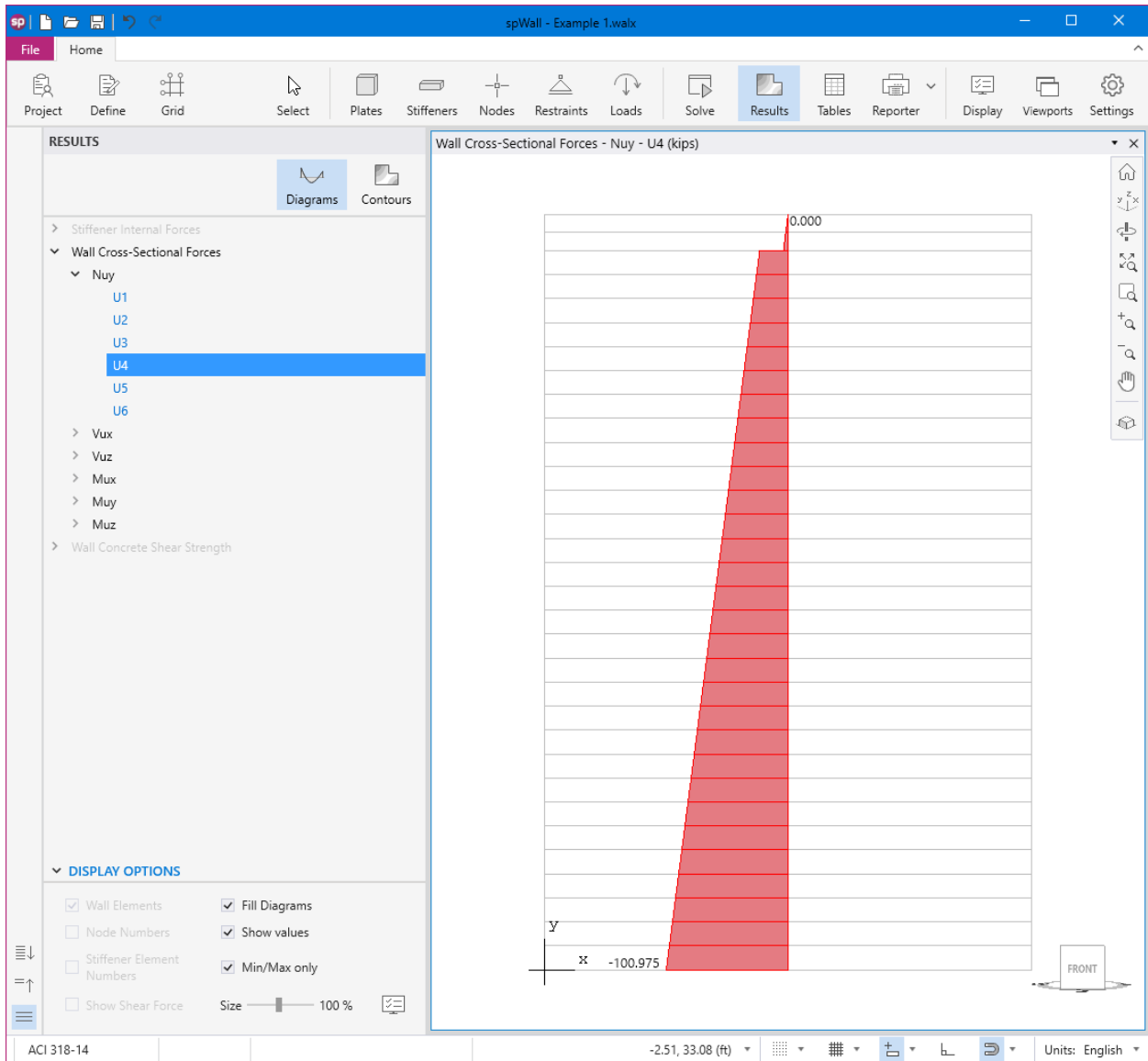

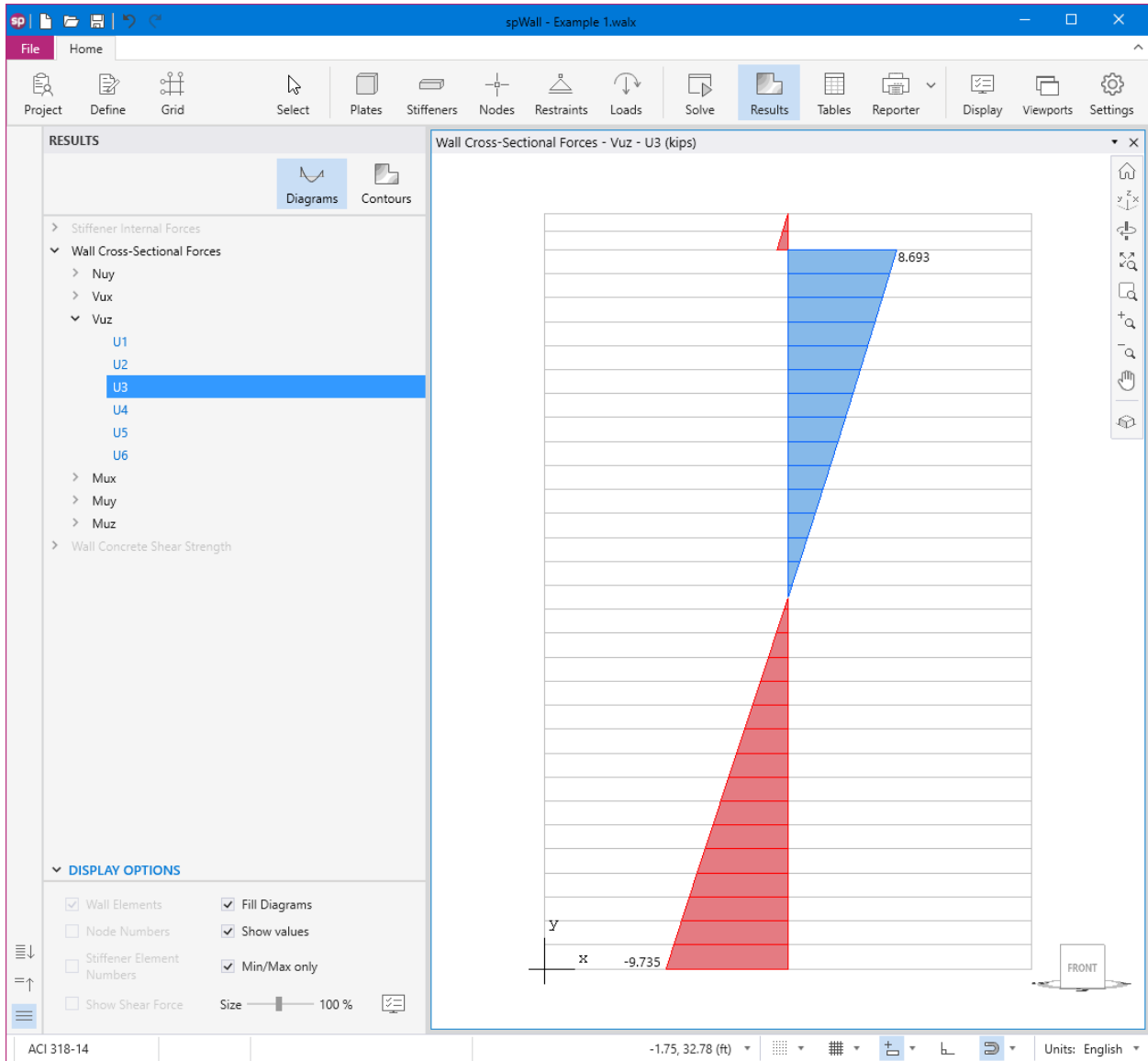

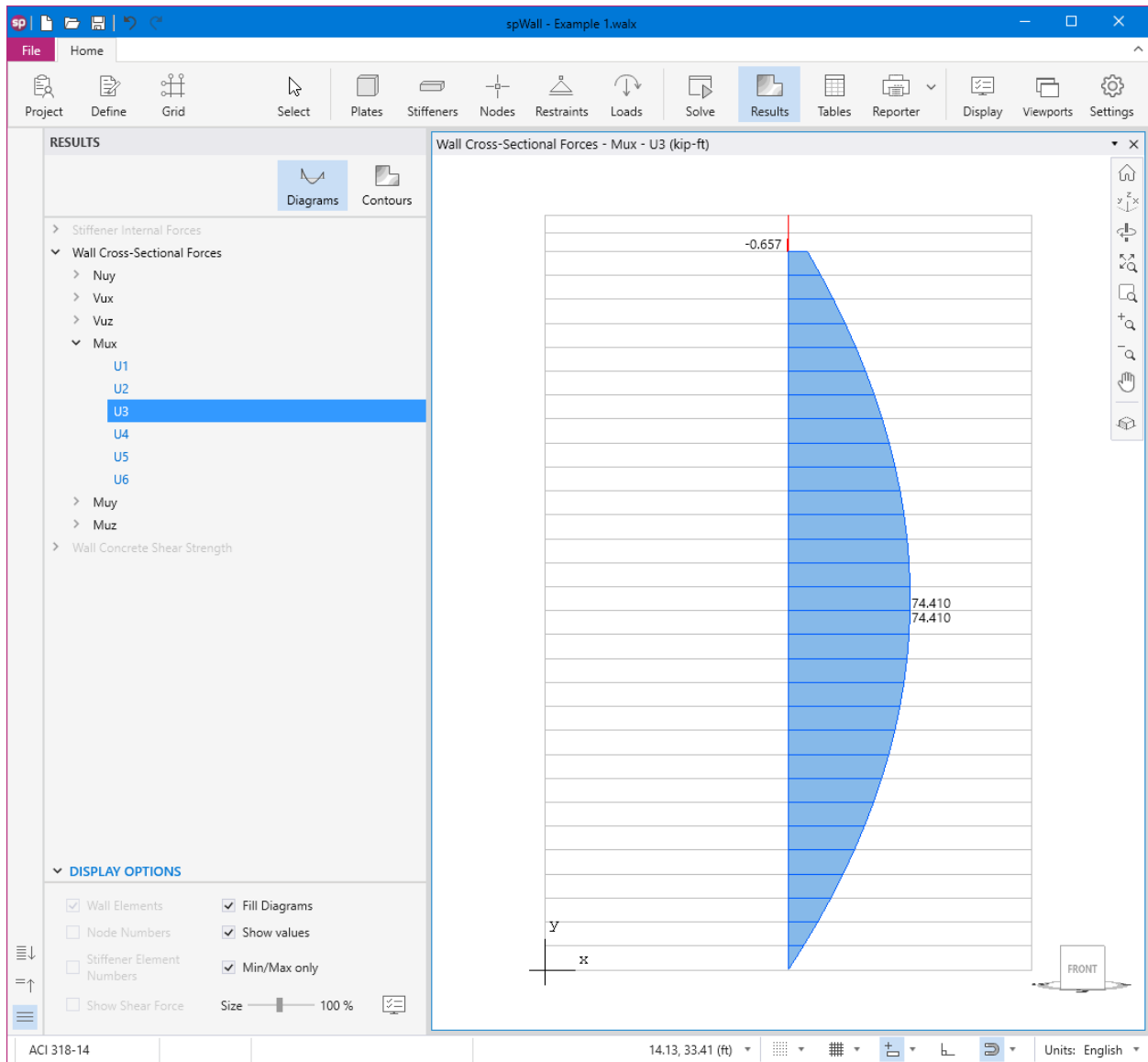

20. Results can be also viewed in table format by selecting the **Tables** command from the **Ribbon**.

Results - Service - Nodal Displacements - S2

NOTE: Coordinate System: Global

Node	Dx	Dy	Dz
	in	in	in
22	-0.00006	-0.00017	-0.00273
23	-0.00005	-0.00013	-0.00270
24	-0.00004	-0.00012	-0.00268
25	-0.00003	-0.00012	-0.00265
26	-0.00002	-0.00012	-0.00264
27	-0.00002	-0.00012	-0.00262
28	-0.00001	-0.00012	-0.00261
29	-0.00001	-0.00012	-0.00260
30	-0.00001	-0.00012	-0.00259
31	0.00000	-0.00012	-0.00259
32	0.00000	-0.00012	-0.00259
33	0.00000	-0.00012	-0.00259
34	0.00001	-0.00012	-0.00259
35	0.00001	-0.00012	-0.00260
36	0.00001	-0.00012	-0.00261
37	0.00002	-0.00012	-0.00262
38	0.00002	-0.00012	-0.00264
39	0.00003	-0.00012	-0.00265
40	0.00004	-0.00012	-0.00268
41	0.00005	-0.00013	-0.00270
42	0.00006	-0.00017	-0.00273
43	-0.00011	-0.00029	-0.00544
44	-0.00009	-0.00026	-0.00539
45	-0.00007	-0.00024	-0.00533

Ranges

	From	To
Plates <input checked="" type="checkbox"/> All	1	640
Stiffeners <input checked="" type="checkbox"/> All	1	1
Nodes <input checked="" type="checkbox"/> All	1	693

21. Results can be printed or exported in different formats by selecting the **Reporter** command from the **Ribbon**.

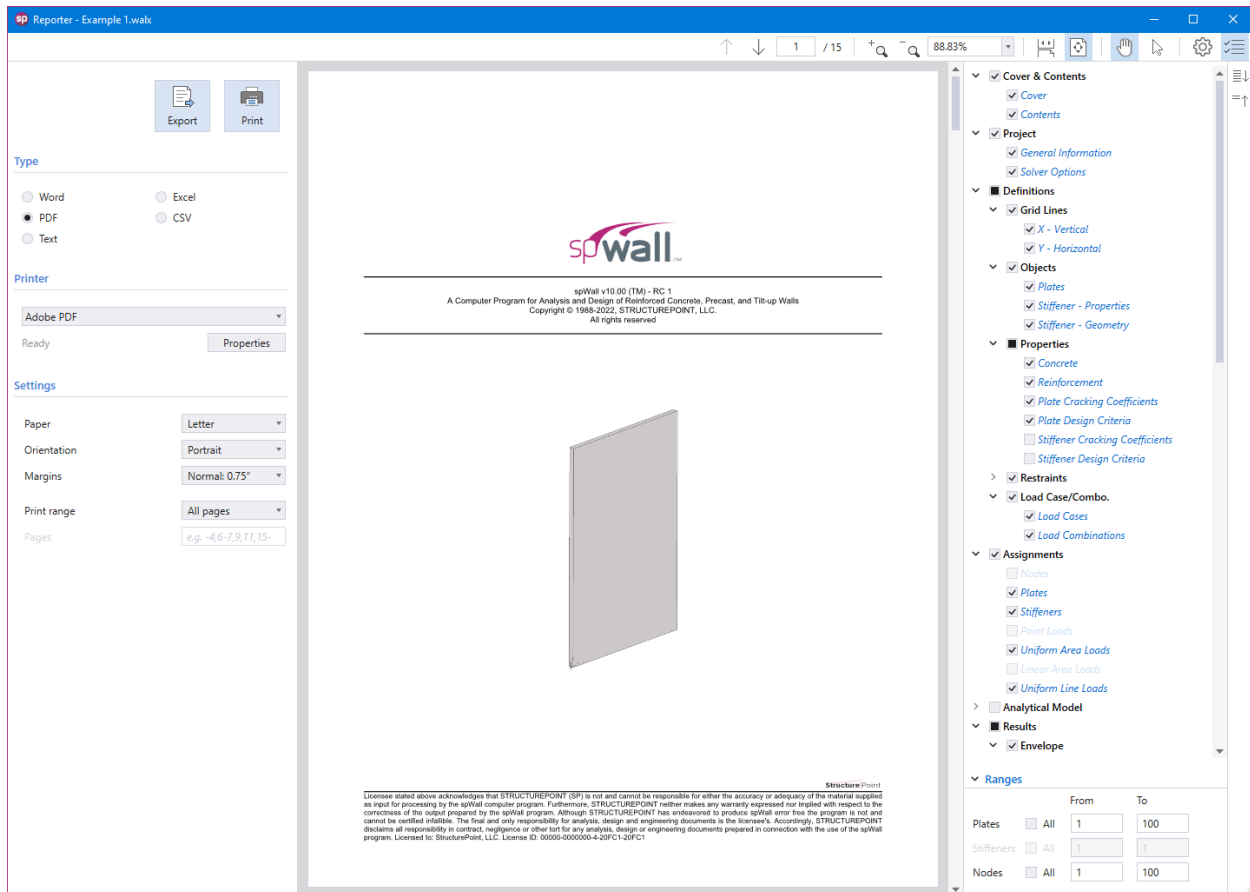

8.2. Example 2 - Cantilever Retaining Wall

8.2.1. Problem Formulation

Design the stem of the reinforced concrete cantilevered retaining wall¹ show below.

Design data

$$f'_c = 3,000 \text{ psi}$$

$$w_c = 150 \text{ pcf}$$

$$\nu \text{ (Poisson's ratio)} = 0.15$$

$$f_y = 40,000 \text{ psi}$$

$$E_s = 29,000 \text{ ksi}$$

$$\text{Wall thickness} = 12 \text{ in. @ top of the wall}$$

$$= 21 \text{ in. @ bottom of the wall}$$

Lateral earth pressure:

$$\text{Due to soil weight} = 640 \text{ psf}$$

$$\text{Due to surcharge} = 256 \text{ psf}$$

It is assumed that the wall acts as a one-way system in the Y-direction. Therefore, strip of 1 ft width is modeled.

¹ C.K. Wang, C.G. Salmon, J.A. Pincheira, and G.J. Parra-Montesinos, *Reinforced Concrete Design*, Oxford University Press, Eighth Edition, 2018, Example 15.7.4.1

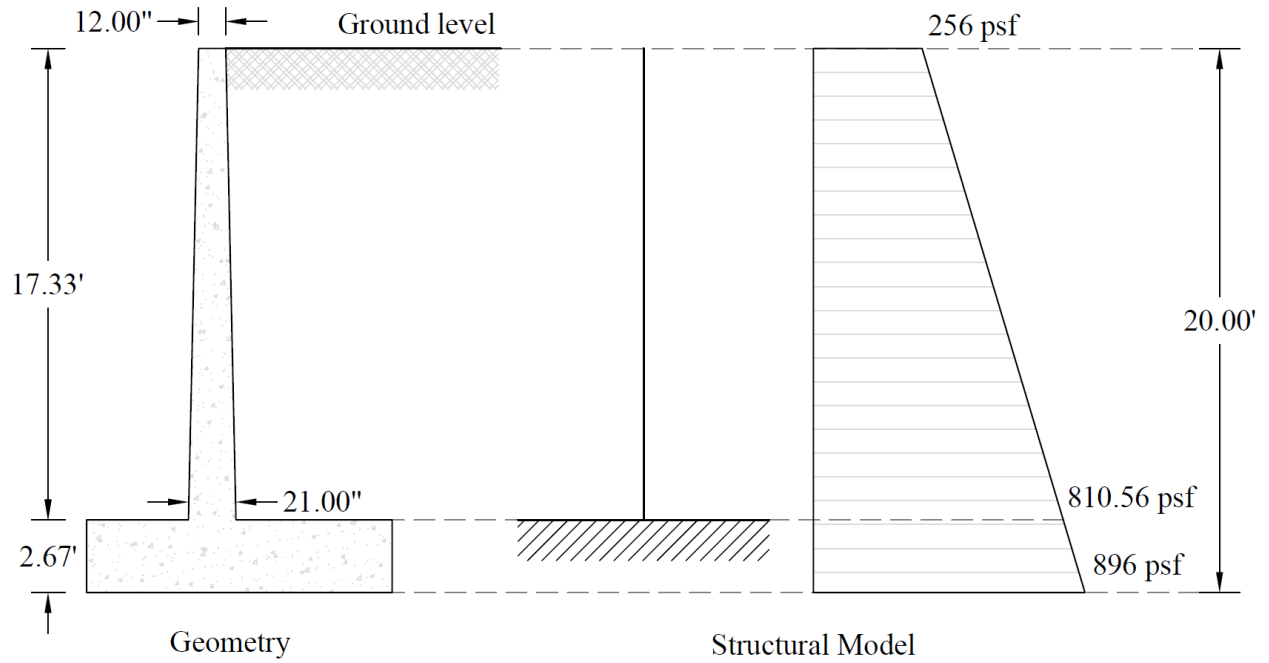
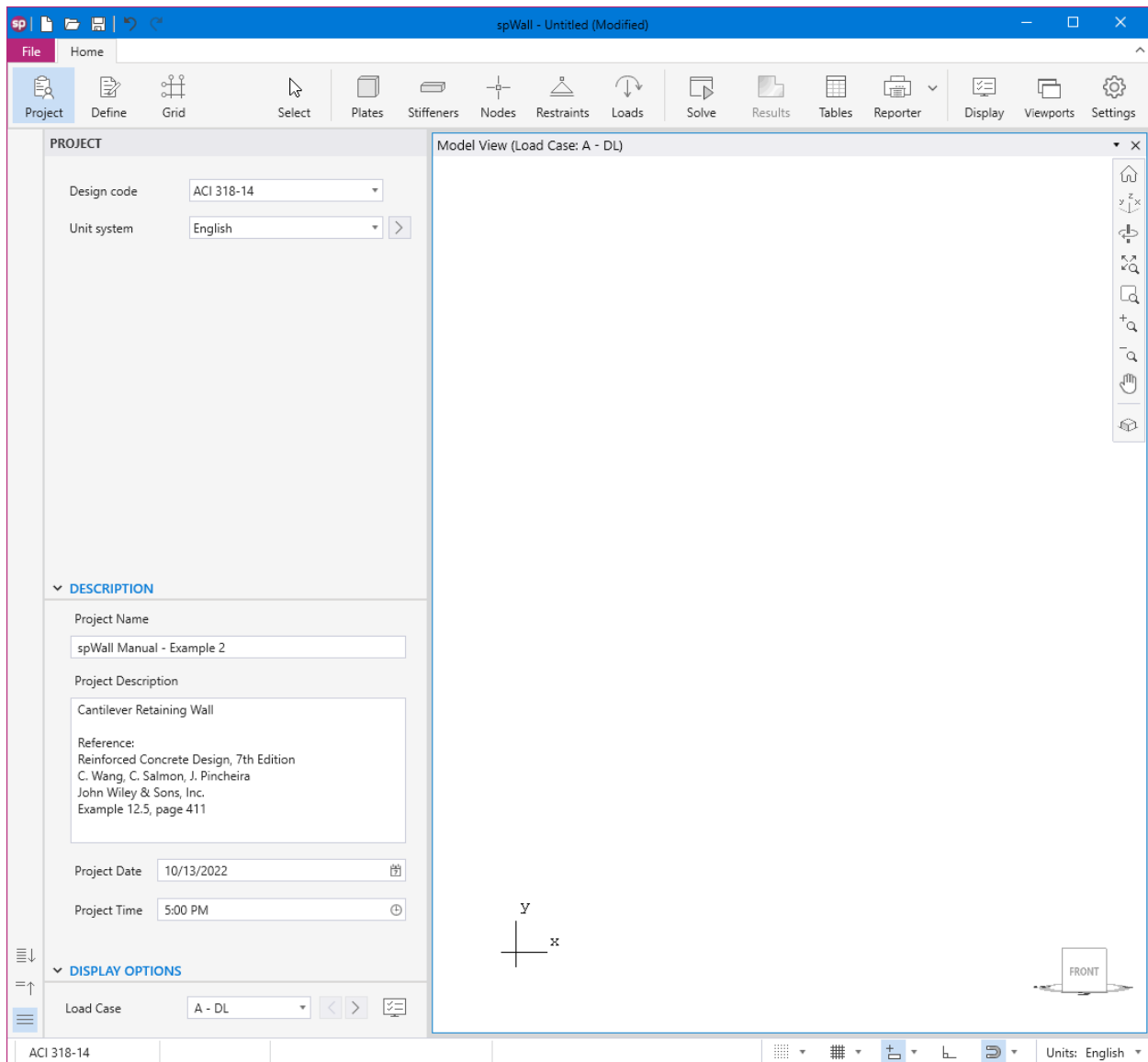

Figure 8.2 – Retaining Wall Geometry & Model Loading

8.2.2. Preparing the Input

1. From the Start screen, select **New Project**.
2. In the **Main Program Window**, select **Project** from the **Ribbon**.
 - Select the DESIGN CODE, UNIT SYSTEM, and enter the PROJECT NAME and PROJECT DESCRIPTION.



3. From the **Ribbon**, select **Grid**.

- Click on the **Generate** option on the left panel to have the program surface the following:

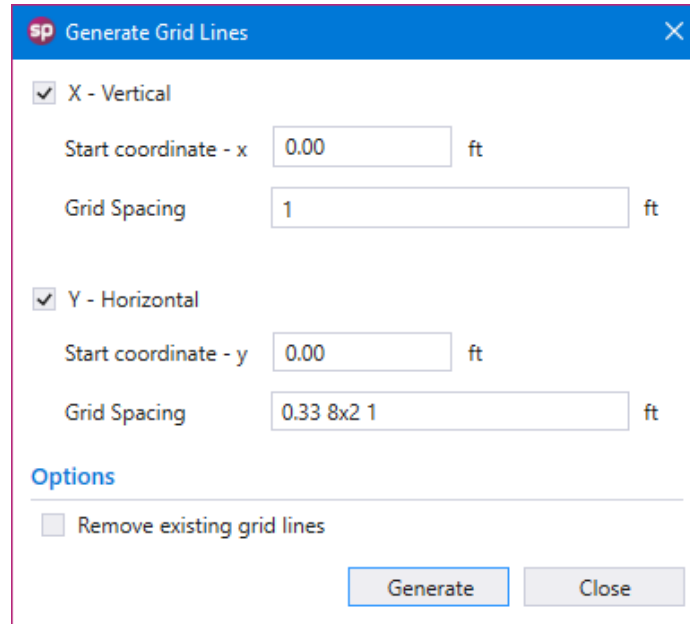

- Place a check mark in the X - VERTICAL box and enter the following values in the corresponding text boxes:

START COORDINATE - X: 0 . 0

GRID SPACING: 1 . 0

- Place a check mark in the Y - VERTICAL box and enter the following values in the corresponding text boxes:

START COORDINATE - Y: 0 . 0

GRID SPACING: 0 . 33 8x2 1

- Click on the GENERATE button to return to the main window. Notice how the VERTICAL and HORIZONTAL grid lines now appear in the VIEWPORT.

spWall - Untitled (Modified)

File Home

Project Define Grid Select Plates Stiffeners Nodes Restraints Loads Solve Results Tables Reporter Display Viewports Settings

GRIDS

Add-H Add-V Generate

VERTICAL

Label	Coordinate-X	Spacing
	ft	ft
A	0.00	0.00
B	1.00	1.00

HORIZONTAL

Label	Coordinate-Y	Spacing
	ft	ft
0	0.00	0.00
1	0.33	0.33
2	2.33	2.00
3	4.33	2.00
4	6.33	2.00
5	8.33	2.00
6	10.33	2.00
7	12.33	2.00
8	14.33	2.00
9	16.33	2.00

DISPLAY OPTIONS

Labels Units

Dimensions Size 100%

Model View (Load Case: A - DL)

ACI 318-14 8.03, 18.94 (ft) Units: English

- From the **Ribbon**, select **Define**, then choose **Plates** from **Objects** to display the **Plates** dialog box.

To model the wall taper, several thicknesses are used to capture the variable thickness along the wall height.

- Input t12 for LABEL and 12.00 in. for THICKNESS.
- Repeat same steps for thicknesses 13.00 in. through 21.00 in.
- Click on the APPLY button to apply the changes.

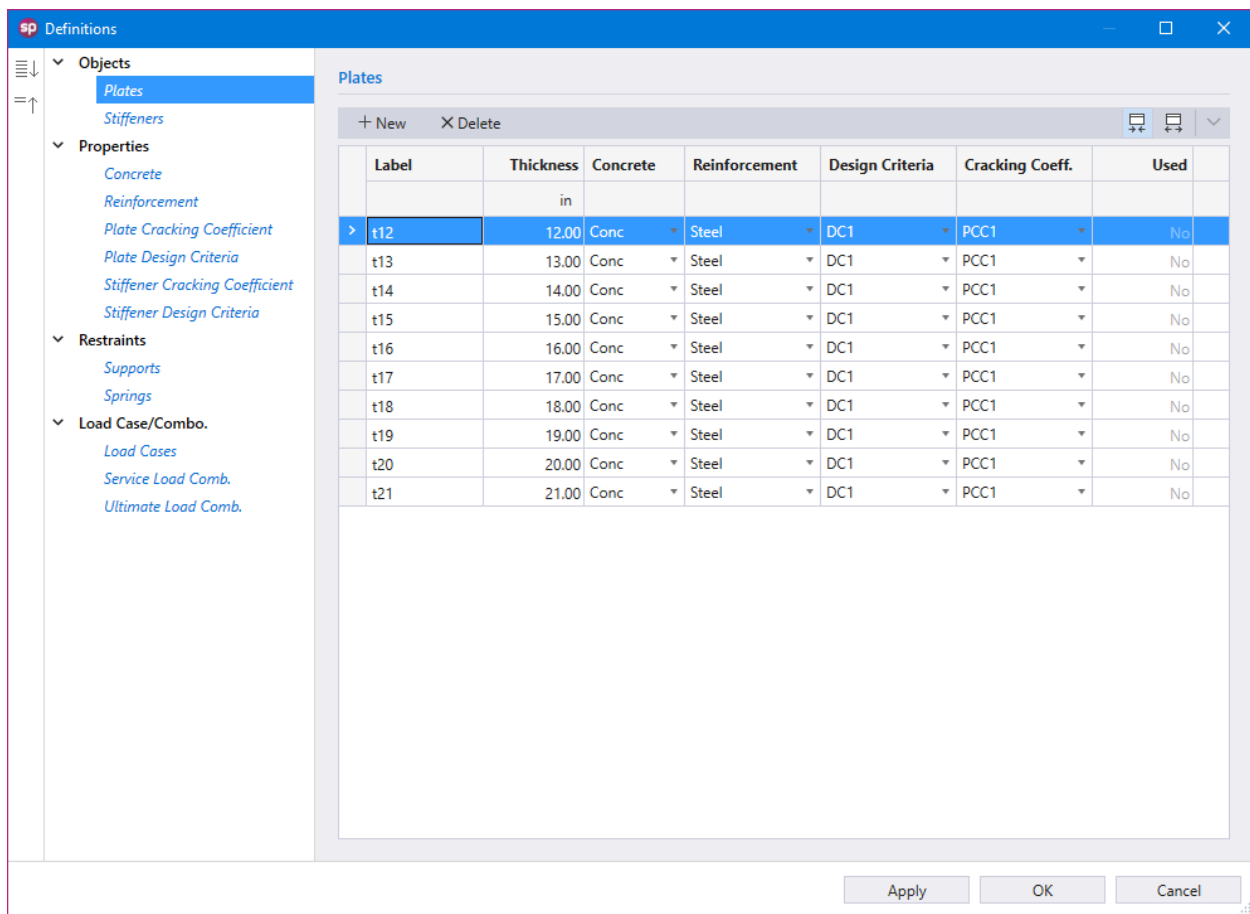

5. Click on **Concrete** from **Properties** to display the **Concrete** dialog box.

- Enter the following:

LABEL: Conc

UNIT WEIGHT: 150 pcf

COMPRESSIVE STRENGTH: 3 ksi

YOUNG’S MODULUS: 3320.56 ksi

POISSON’S RATIO: 0.15

- Click on the APPLY button to apply the changes.

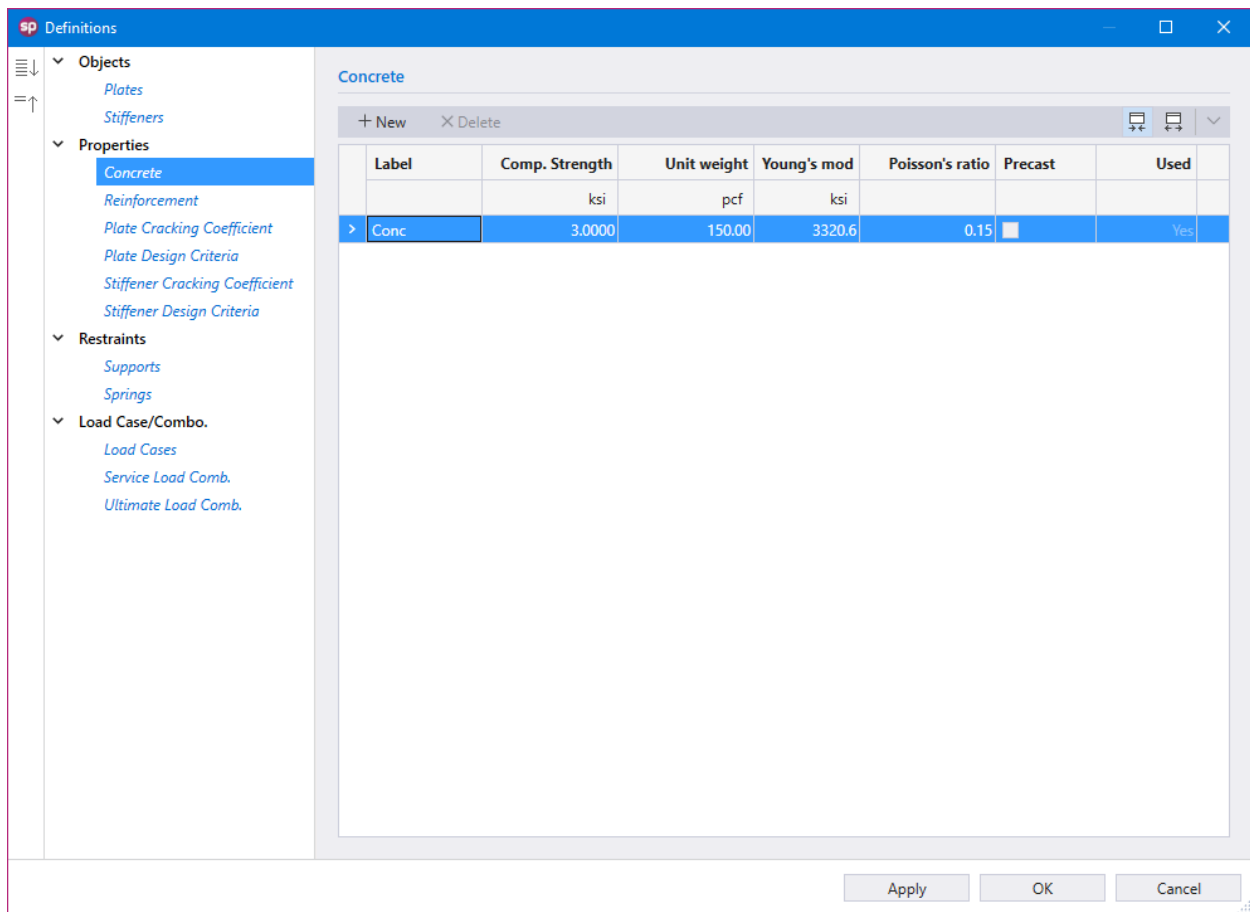

6. Click on **Reinforcement** from **Properties** to display the **Reinforcement** dialog box.

- Enter the following:

LABEL: Steel

YIELD STRENGTH: 40 ksi

YOUNG'S MODULUS: 29000 ksi

- Click on the APPLY button to apply the changes.

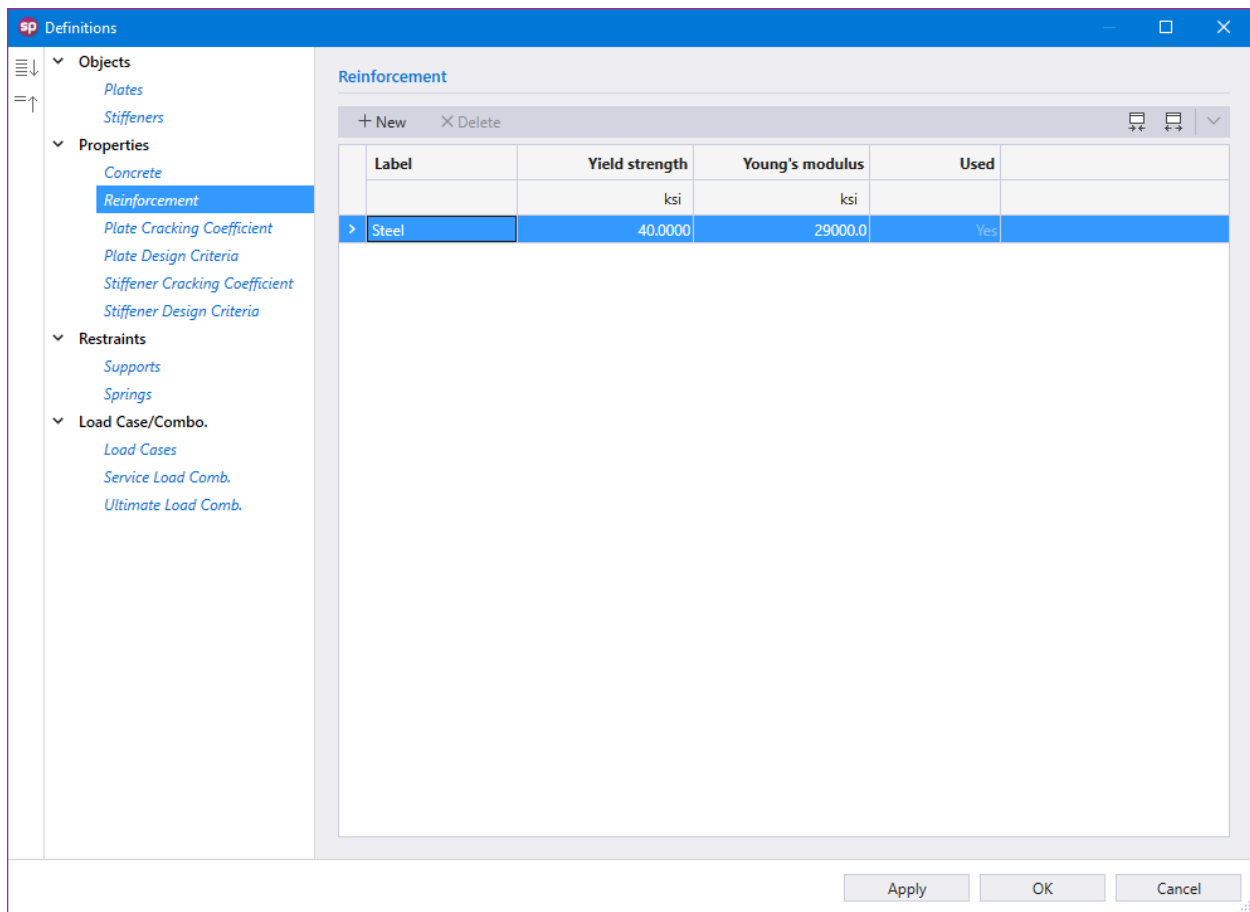

7. Click on **Plate Cracking Coefficient** from **Properties** to display the **Plate Cracking Coefficient** dialog box.

- Enter the following:

LABEL: PCC1

Service Combinations:

IN-PLANE: 1.00

OUT-OF-PLANE: 1.00

Ultimate Combinations:

IN-PLANE: 1.00

OUT-OF-PLANE: 1.00

- Click on the **APPLY** button to apply the changes.

Definitions

- Objects
 - Plates
 - Stiffeners
- Properties
 - Concrete
 - Reinforcement
 - Plate Cracking Coefficient**
 - Plate Design Criteria
 - Stiffener Cracking Coefficient
 - Stiffener Design Criteria
- Restraints
 - Supports
 - Springs
- Load Case/Combo.
 - Load Cases
 - Service Load Comb.
 - Ultimate Load Comb.

Plate Cracking Coefficient

+ New X Delete

Label	Service Combinations		Ultimate Combinations		Used
	In-plane	Out-of-plane	In-plane	Out-of-plane	
> PCC1	1.00	1.00	1.00	1.00	Yes

Apply OK Cancel

8. Click on **Plate Design Criteria** from **Properties** to display the **Plate Design Criteria** dialog box.

- Enter the following:

LABEL:	DC1
REINFORCEMENT LAYOUT:	Two Curtains
REINFORCEMENT RATIO:	
HORIZONTAL MIN.:	0.20 %
HORIZONTAL MAX.:	8.00 %
VERTICAL MIN.:	0.12 %
VERTICAL MAX.:	8.00 %
REINFORCEMENT LOCATION:	
BACK CURTAIN HOR. (BH):	3.00 in.
BACK CURTAIN VER. (BV):	2.50 in.
FRONT CURTAIN HOR. (FH):	2.00 in.
FRONT CURTAIN VER. (FV):	2.50 in.

- Click on the **APPLY** button to apply the changes.

Definitions
□
✕

Objects

- Plates
- Stiffeners

Properties

- Concrete
- Reinforcement
- Plate Cracking Coefficient
- Plate Design Criteria
- Stiffener Cracking Coefficient
- Stiffener Design Criteria

Restraints

- Supports
- Springs

Load Case/Combo.

- Load Cases
- Service Load Comb.
- Ultimate Load Comb.

Plate Design Criteria

Label:

Reinf. Layout:

Allow one curtain in walls thicker than 10 in.

Reinforcement Ratio

Horizontal Min. %

Horizontal Max. %

Vertical Min. %

Vertical Max. %

Allow minimum below code

Reinforcement Location

Back Curtain Hor. (BH) in

Back Curtain Vert. (BV) in

Front Curtain Hor. (FH) in

Front Curtain Vert. (FV) in

+ New
✕ Delete

Label	Reinf. L.	One Cu	Rmin (l)	Rmax (l)	Rmin (r)	Rmax (r)	Min. belo	Back H.	Back V.	Front H.	Front V.	Used
> DC1	Two C	■	0.20	8.00	0.12	8.00	■	3.00	2.50	2.00	2.50	Yes

9. Click on **Supports** from **Restraints** to display the **Supports** dialog box².

- Enter the following:

LABEL: Fixed

- Select all restraints to model fixed support end conditions.
- Click on the APPLY button to apply the changes.

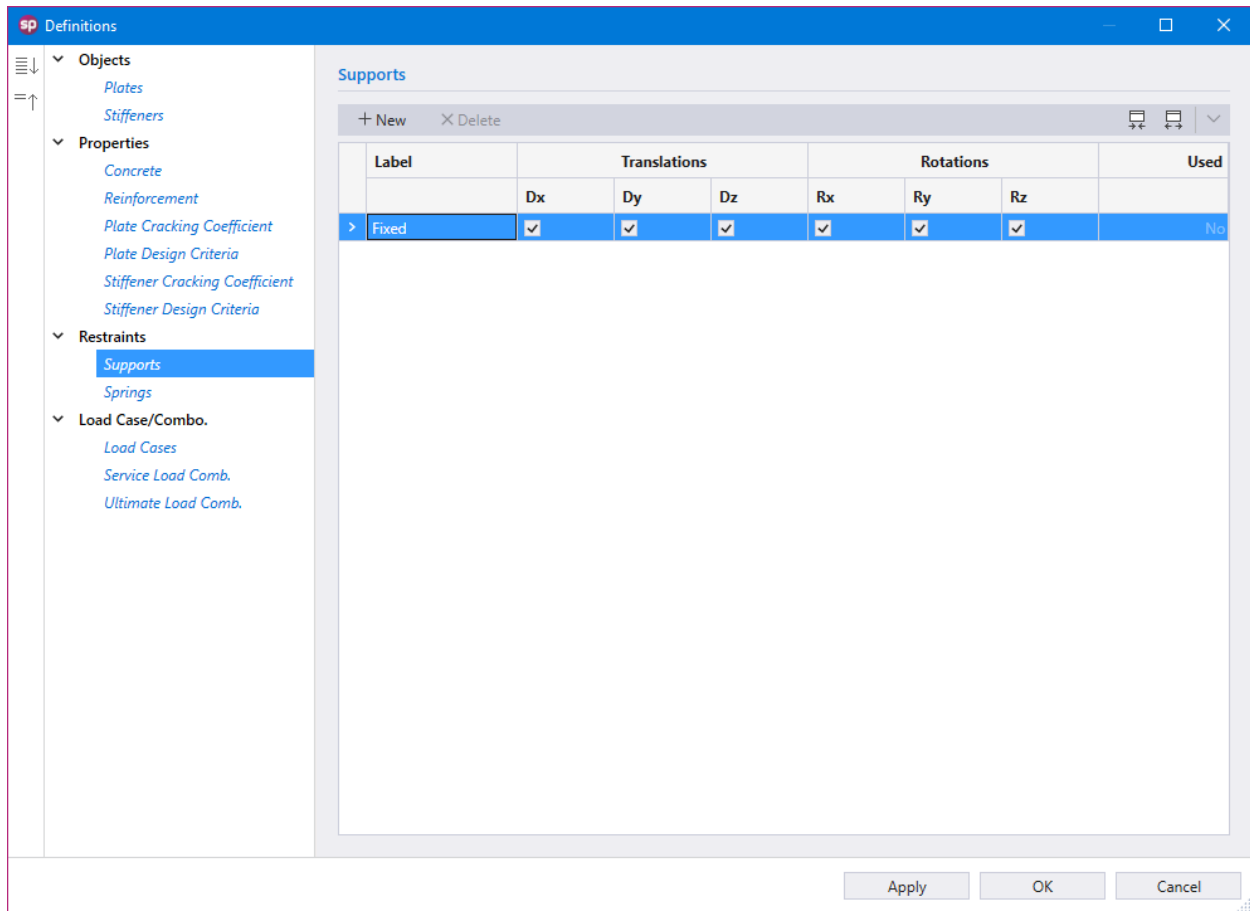

² For simplicity, only external boundary conditions are modeled in this example. Additionally, symmetry end conditions could be applied to account for the fact that the one-foot-wide strip under consideration is a part of a larger wall assumed to act as a one-way system in the vertical (Y) direction. This condition can be modeled by restraining D_x , R_y , and R_z degrees of freedom along the vertical edges of the strip to restrict horizontal displacement and to allow curvature deformation only in the vertical direction. In this example, however, the increased accuracy of modeling boundary conditions has only a minimal impact on the final results.

11. Click on **Service Load Combinations** from **Load Case/Combo.** to display the **Service Load Combinations** dialog box.

- Enter the following load combinations shown in the figure below:

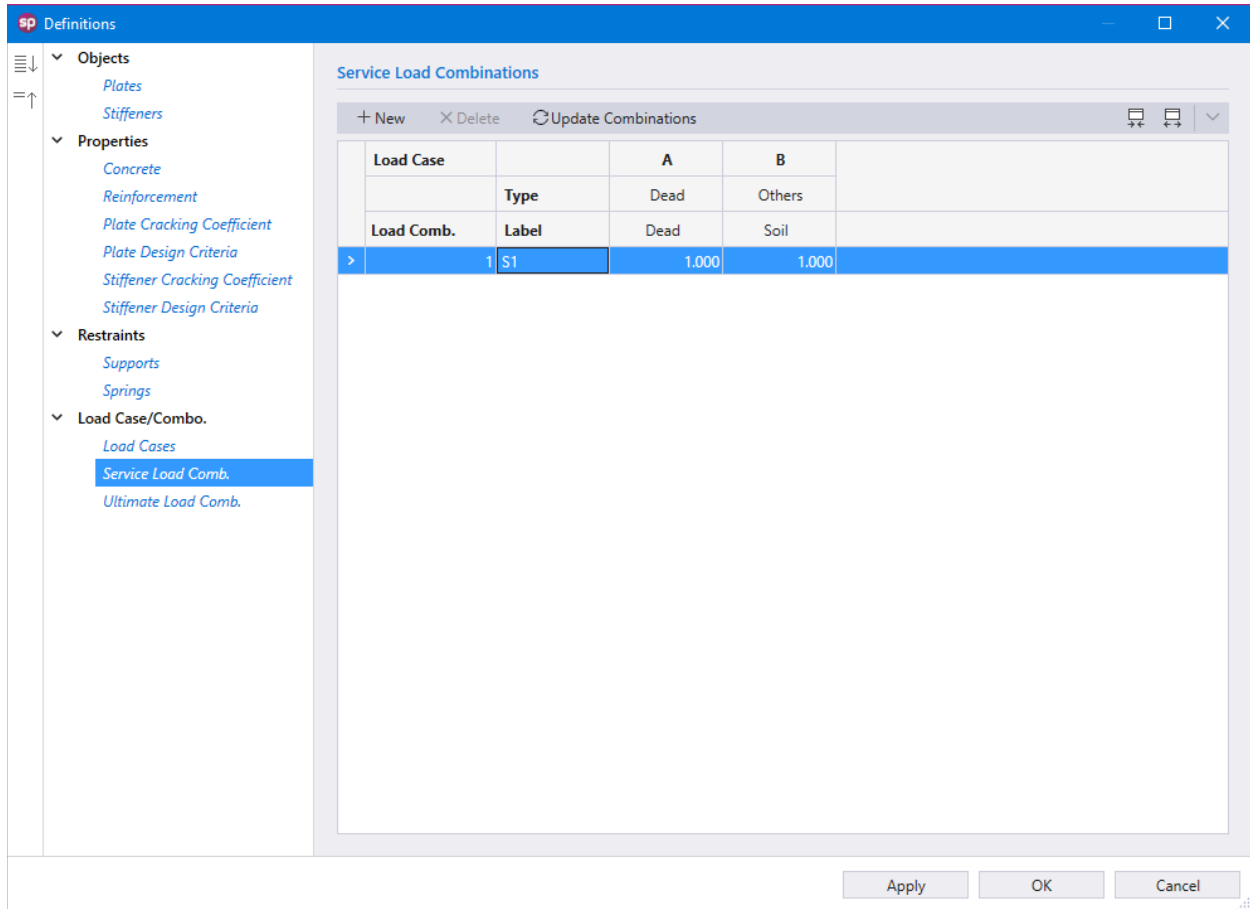

12. Click on **Ultimate Load Combinations** from **Load Case/Combo.** to display the **Ultimate Load Combinations** dialog box.

- Enter the following load combinations shown in the figure below:

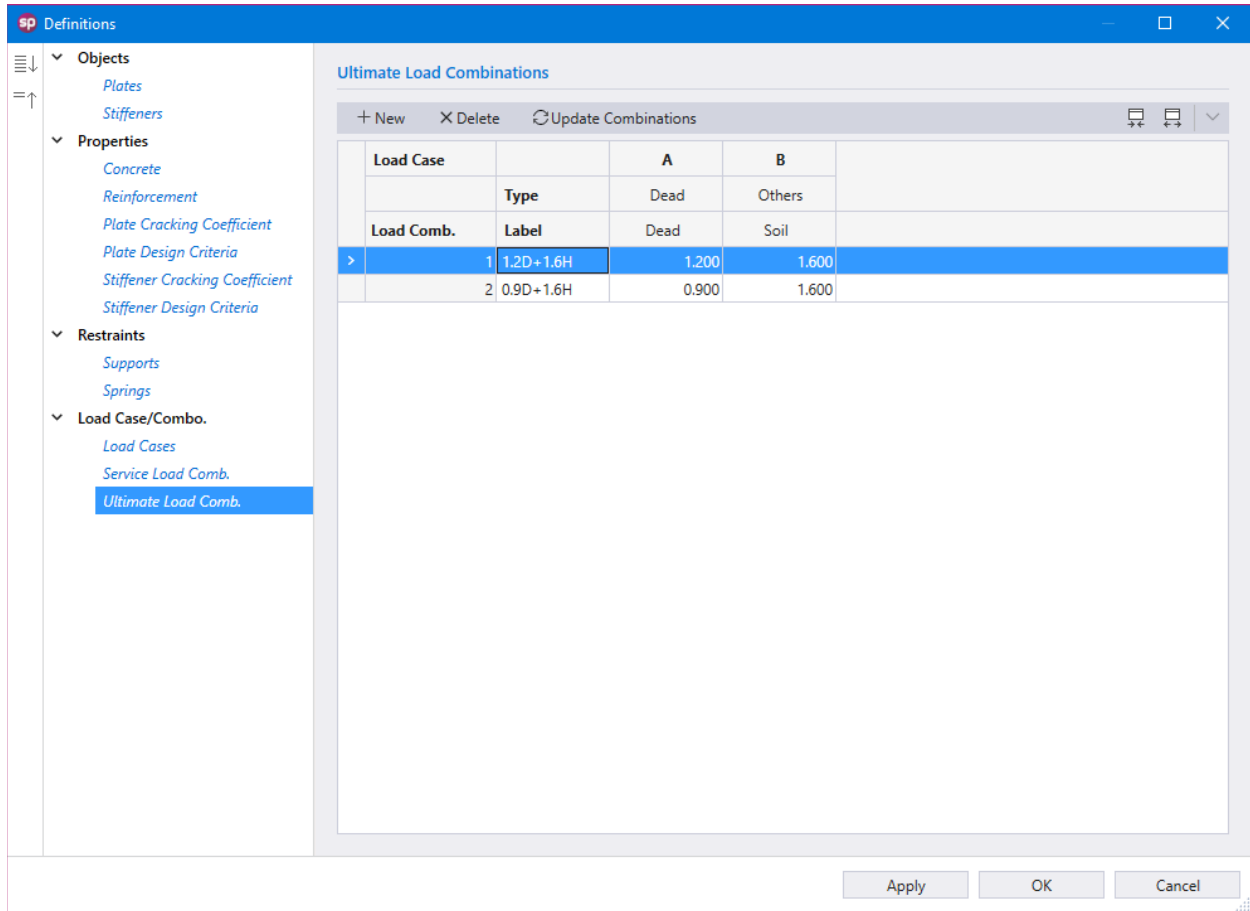

8.2.3. Assigning Properties

13. From the **Ribbon**, select **Plates** command.

- In the left panel, select **Rectangle** then select t12 from LABEL.
- In the VIEWPORT, marquee-select the region (A, 9) – (B, 10) to apply the selected plate to the top wall segment.

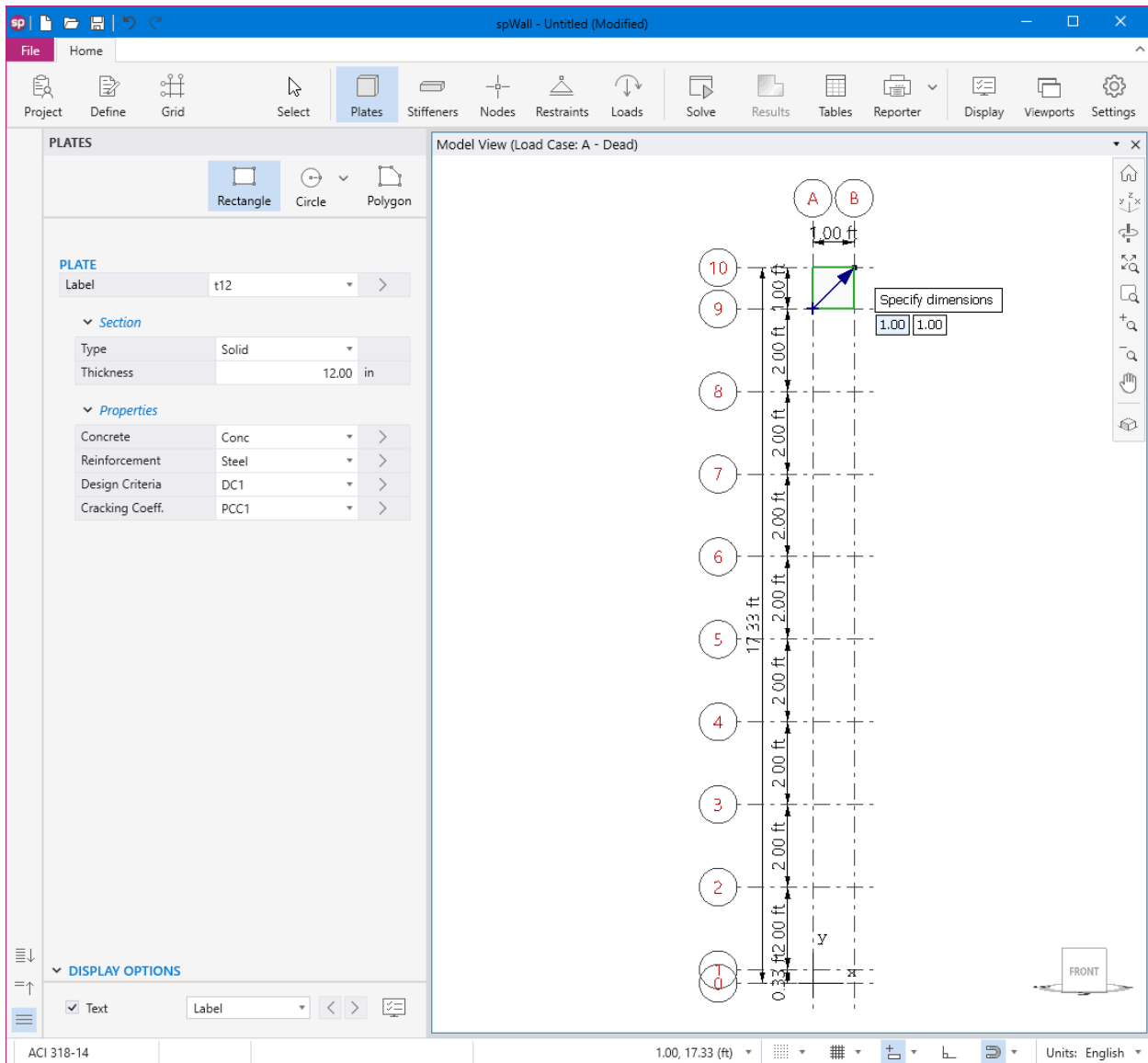

- Select t13 from LABEL.
- In the VIEWPORT, marquee-select the region (A, 8) – (B, 9) to apply the selected plate to the next wall segment.

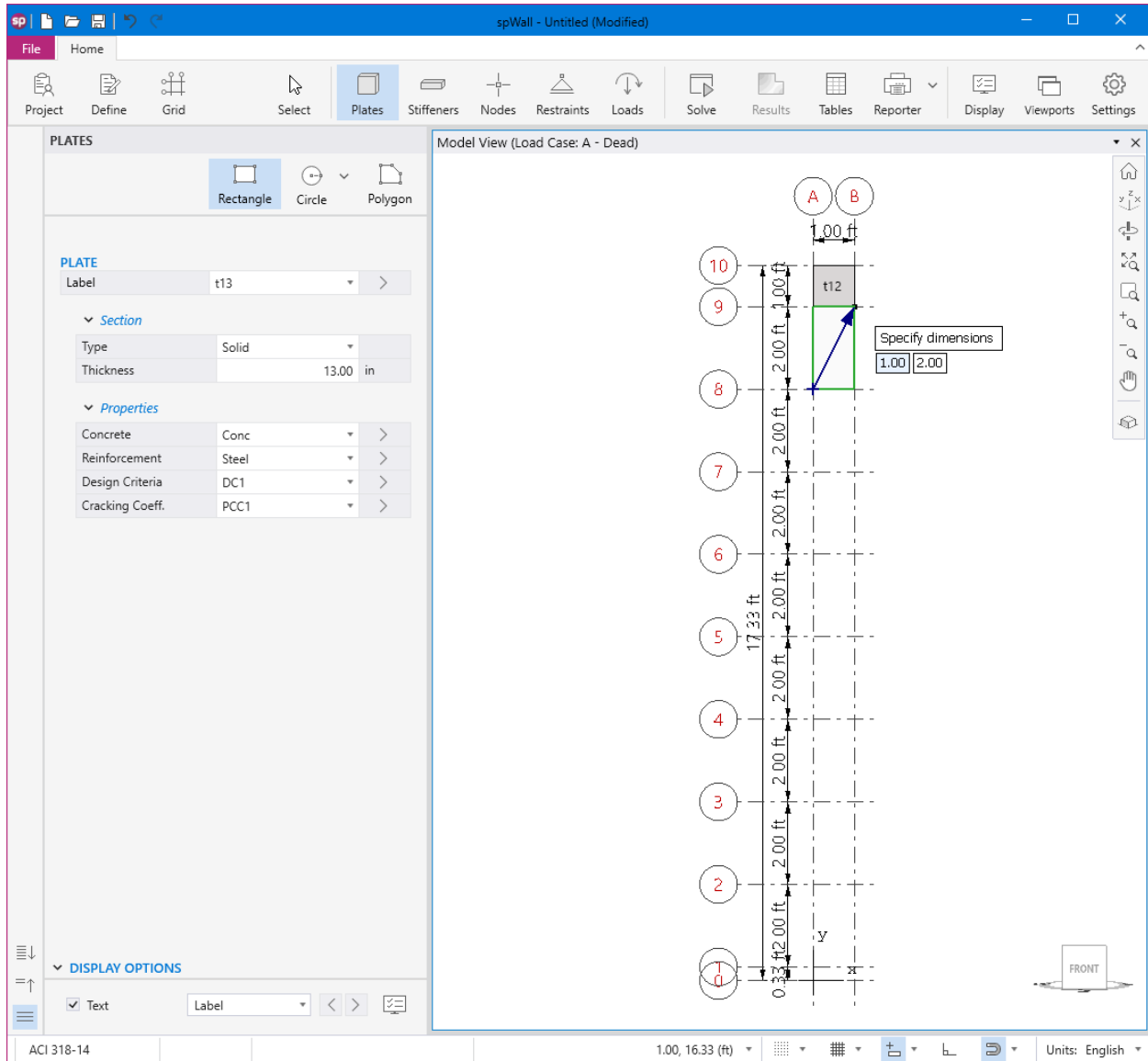

- Continue applying different thicknesses to wall segments as described above, using one plate label for each remaining segment.
- The last remaining label at the bottom of the wall will be assigned with plate label t21. The selected plate segment is redrawn in green.

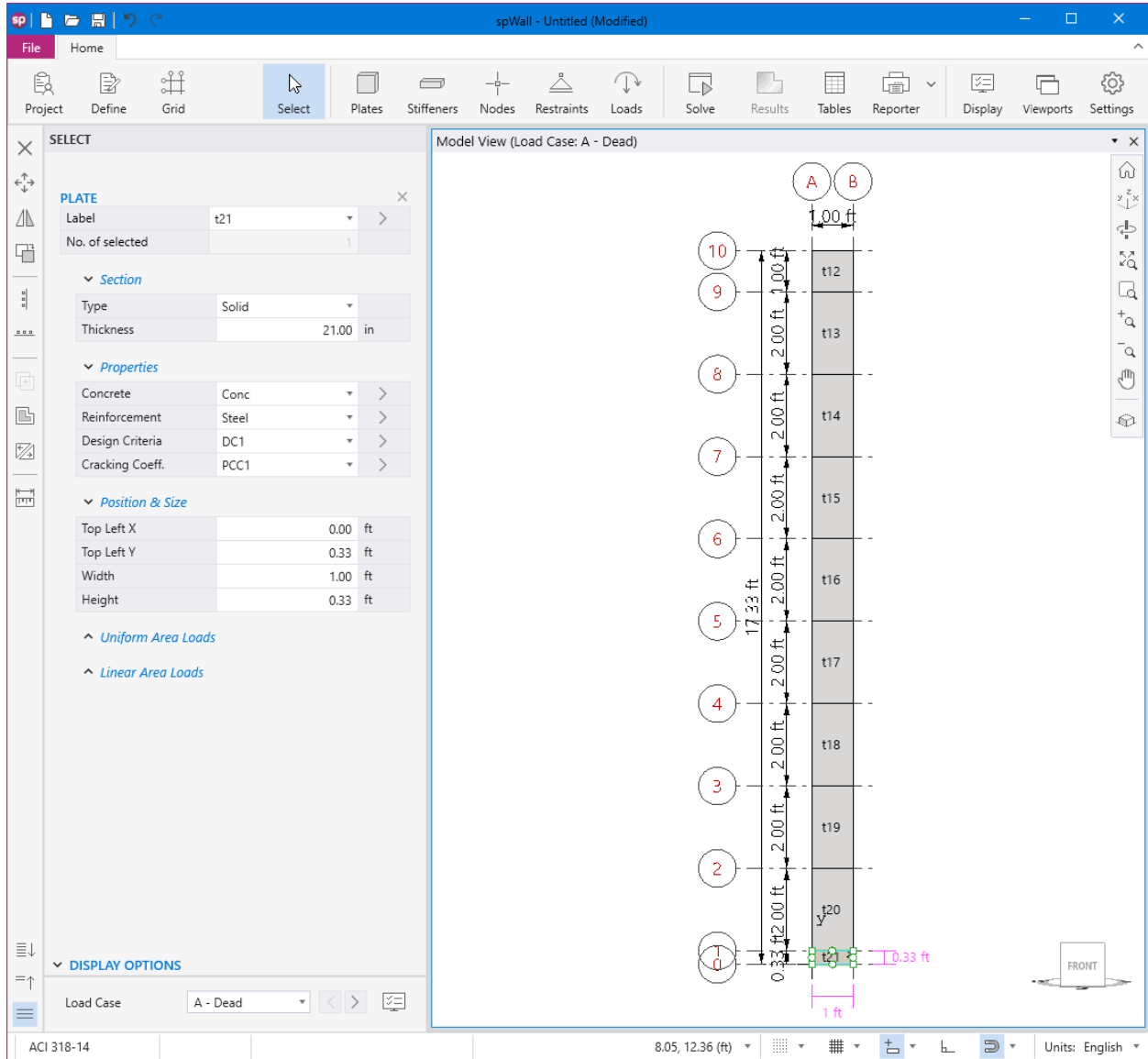

8.2.4. Assigning Supports

14. From the **Ribbon**, select **Stiffeners** command.

- In the left panel, select **Null**.
- Apply at the bottom of the wall as shown in the figure below.

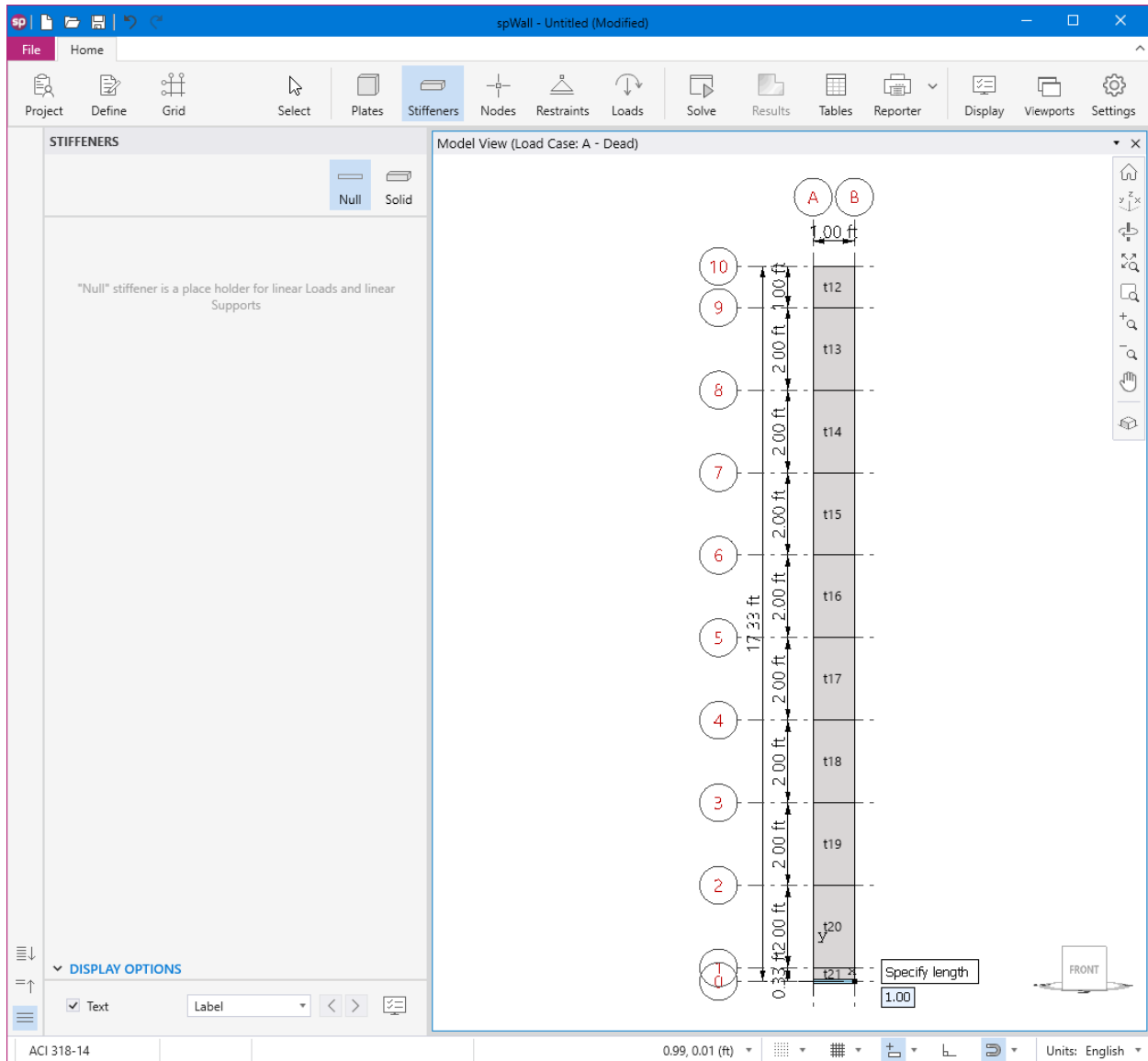

15. From the **Ribbon**, select **Restraints** command.

- In the left panel, select **Linear** then select FIXED from LABEL.
- Apply FIXED support to the bottom null stiffener as shown in the figure below.

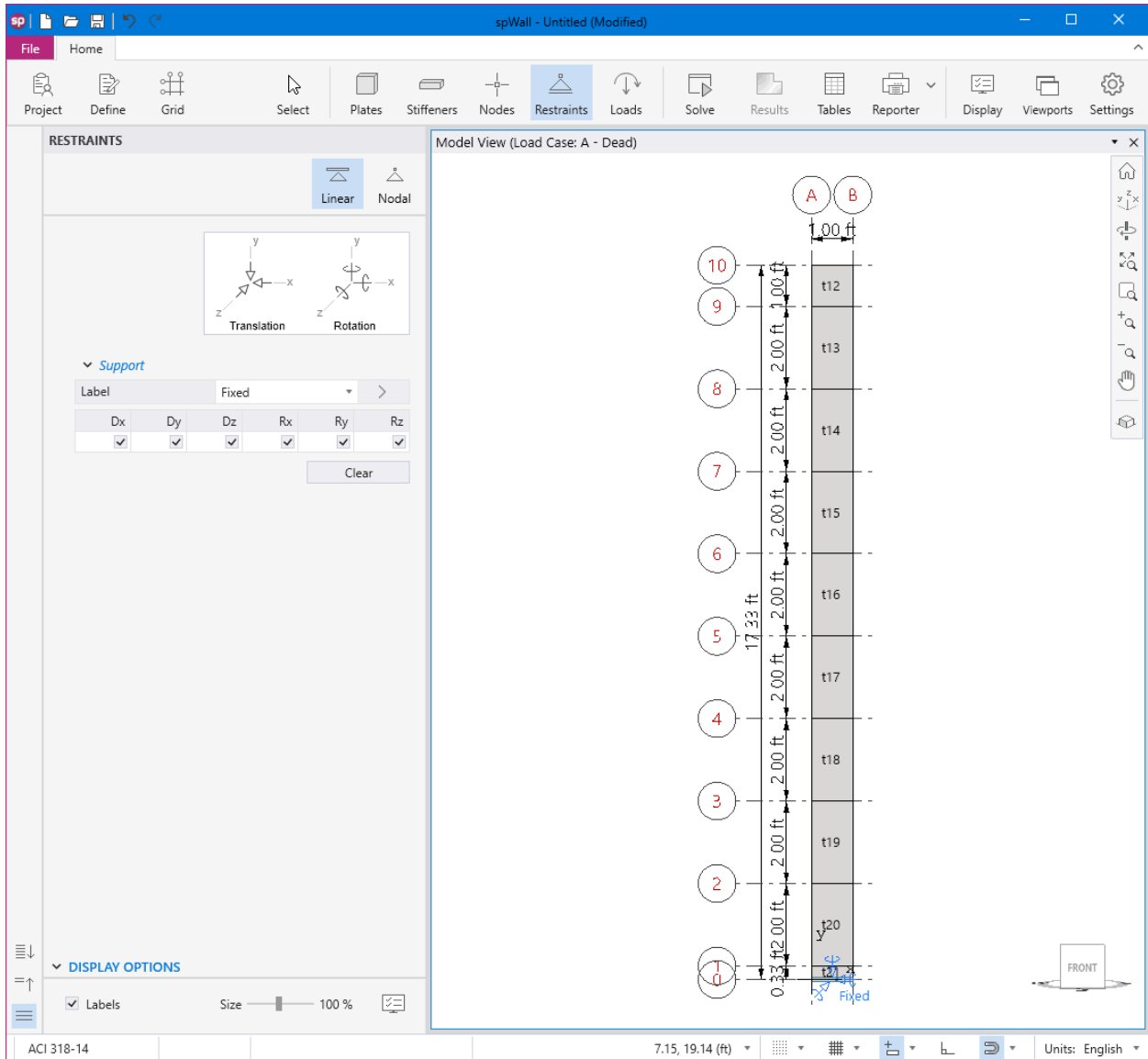

8.2.5. Assigning Loads

16. From the **Ribbon**, select **Loads** command.

- In the left panel, select **Linear Area** then select B-SOIL from LOAD CASE and enter the following:

Y_{TOP} : 17.33 ft

Y_{BOTTOM} : -2.67 ft

W_Z AT TOP: -256.00 psf

W_Z AT BOTTOM: -896.00 psf

- Apply to the entire wall as shown in the figure below.

spWall - Untitled (Modified)

File Home

Project Define Grid Select Plates Stiffeners Nodes Restraints Loads Solve Results Tables Reporter Display Viewports Settings

LOADS

Lin. Area Uni. Area Uni. Line Point

Wx Wy Wz

Linear Area Loads

Load Case: B - Soil

	Y ft	Wx psf	Wy psf	Wz psf
Top	17.33	0.0000	0.0000	-256.0000
Bottom	-2.67	0.0000	0.0000	-896.0000

Clear loads

Options

Replace existing load
 Add to existing load

Display Options

Values
 Units

Size 100%

Model View (Load Case: B - Soil)

10 1.00 ft
Wz_top (-256 psf)
Wz_bot (-288 psf)

9 2.00 ft
Wz_top (-288 psf)
Wz_bot (-352 psf)

8 2.00 ft
Wz_top (-352 psf)
Wz_bot (-416 psf)

7 2.00 ft
Wz_top (-416 psf)
Wz_bot (-480 psf)

6 2.00 ft
Wz_top (-480 psf)
Wz_bot (-544 psf)

5 2.00 ft
Wz_top (-544 psf)
Wz_bot (-608 psf)

4 2.00 ft
Wz_top (-608 psf)
Wz_bot (-672 psf)

3 2.00 ft
Wz_top (-672 psf)
Wz_bot (-736 psf)

2 2.00 ft
Wz_top (-736 psf)
Wz_bot (-800 psf)

1 2.00 ft
Wz_top (-800 psf)
Wz_bot (-810.36 psf)

17.33 ft

0.33 ft

FRONT

ACI 318-14 7.55, 19.99 (ft) Units: English

- Also, you can click on the 3D VIEW icon from **View Controls** (top right of the active viewport) to get a better view of the applied loads.

The screenshot shows the spWall software interface. The main window displays a 3D model of a wall with applied loads. The wall is divided into 10 segments, each 2.00 ft high. The total height is 20.00 ft. The top of the wall is at a height of 17.33 ft. The bottom of the wall is at a height of -2.67 ft. The wall is subjected to a soil load case (B - Soil). The applied loads are shown as arrows pointing towards the wall. The top of the wall is labeled 'A' and 'B'. The bottom of the wall is labeled '1' through '10'.

The **LOADS** panel on the left shows the **Linear Area Loads** table for Load Case B - Soil:

	Y ft	Wx psf	Wy psf	Wz psf
Top	17.33	0.0000	0.0000	-256.0000
Bottom	-2.67	0.0000	0.0000	-896.0000

The **Model View (Load Case: B - Soil)** panel on the right shows the 3D model of the wall with the applied loads. The wall is shown in a perspective view. The applied loads are shown as arrows pointing towards the wall. The top of the wall is labeled 'A' and 'B'. The bottom of the wall is labeled '1' through '10'. The wall is subjected to a soil load case (B - Soil). The applied loads are shown as arrows pointing towards the wall. The top of the wall is labeled 'A' and 'B'. The bottom of the wall is labeled '1' through '10'.

8.2.6. Solving

17. From the **Ribbon**, select **Solve** command.

For **Solve Options**:

- Select YES for INCLUDED SECOND ORDER EFFECTS.
- Select DISABLE for MAXIMUM ALLOWED OUT-OF-PLANE DEFLECTION.
- Check: CHECK CONCRETE SHEAR STRENGTH OF WALL CROSS-SECTIONS (ACI WITH SOLID WALLS ONLY). Only the USE SIMPLIFIED EQUATIONS option will be available because the wall is not uniform due to thickness change along length.

For **Mesh Options**:

- Enter 1 . 00 ft for the MAXIMUM ALLOWED MESH SIZE.

The screenshot displays the spWall software interface during a solve operation. The main window is titled "spWall - Untitled (Modified)". The interface is divided into several panels:

- Top Panel:** Contains a ribbon with tabs for Project, Define, Grid, Select, Plates, Stiffeners, Nodes, Restraints, Loads, Solve (active), Results, Tables, Reporter, Display, Viewports, and Settings.
- SOLVE Panel:**
 - Run:** A large blue button labeled "Run".
 - SOLVE OPTIONS:**
 - Run Options: Analysis & Design
 - Include 2nd Order Effects: Yes
 - Max. allowed Out-of-Plane Deflection: Disable
 - User Defined allowed Deflection: 279.40000 in
 - Check Concrete Shear Strength of Wall Crosssections (ACI with Solid walls only):
 - Use Simplified Equations (selected)
 - Use Detailed Equations (uniform walls only)
 - MESH OPTIONS:**
 - Max. allowed mesh size: 1.00 ft
 - Max. allowed aspect ratio: 36
 - Circle segments: 36
 - Status:**
 - Number of elements: 18
 - Min. element size: 0.33 ft
 - Max. element size: 1.00 ft
 - Max. aspect ratio: 3.03
 - DISPLAY OPTIONS:**
 - Wall Element Numbers:
 - Node Numbers:
 - Stiffener Element Numbers:
- Solve (Mesh) Panel:**
 - Shows a vertical wall model with 10 nodes labeled 1 through 10.
 - Top width: 1.00 ft (between nodes A and B).
 - Base width: 0.33 ft (at node 1).
 - Segment heights: 2.00 ft for segments 1 through 9, and 1.33 ft for segment 10.
 - Total height: 17.33 ft.
 - A "FRONT" view indicator is shown at the bottom right.
- Bottom Panel:**
 - Left: ACI 318-14
 - Right: Units: English

- Click on the **Run** button.
- The spWall **Solver** window is displayed and the solver messages are listed. After the solution is done, the design will be performed and then the focus will immediately be passed to the **Results** scope.

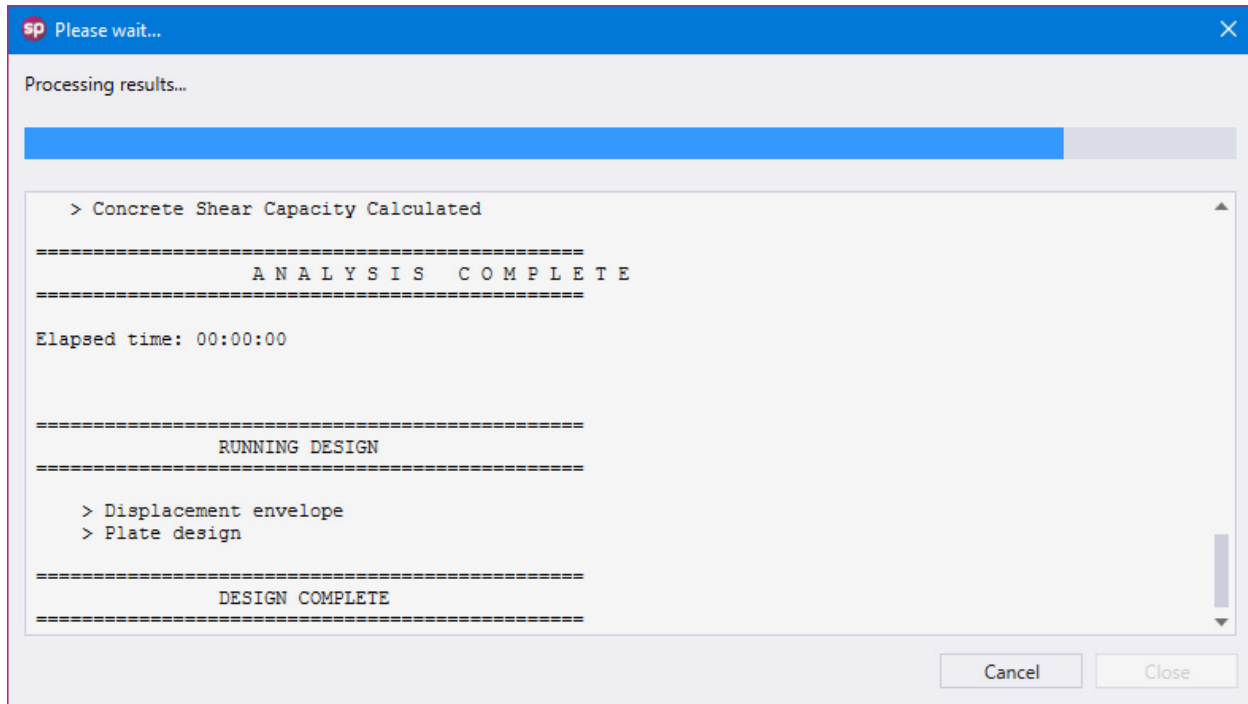

8.2.7. Viewing and Printing Results

- After a successful run, results can be viewed in a contour form by selecting the **Contours** option from the left panel.

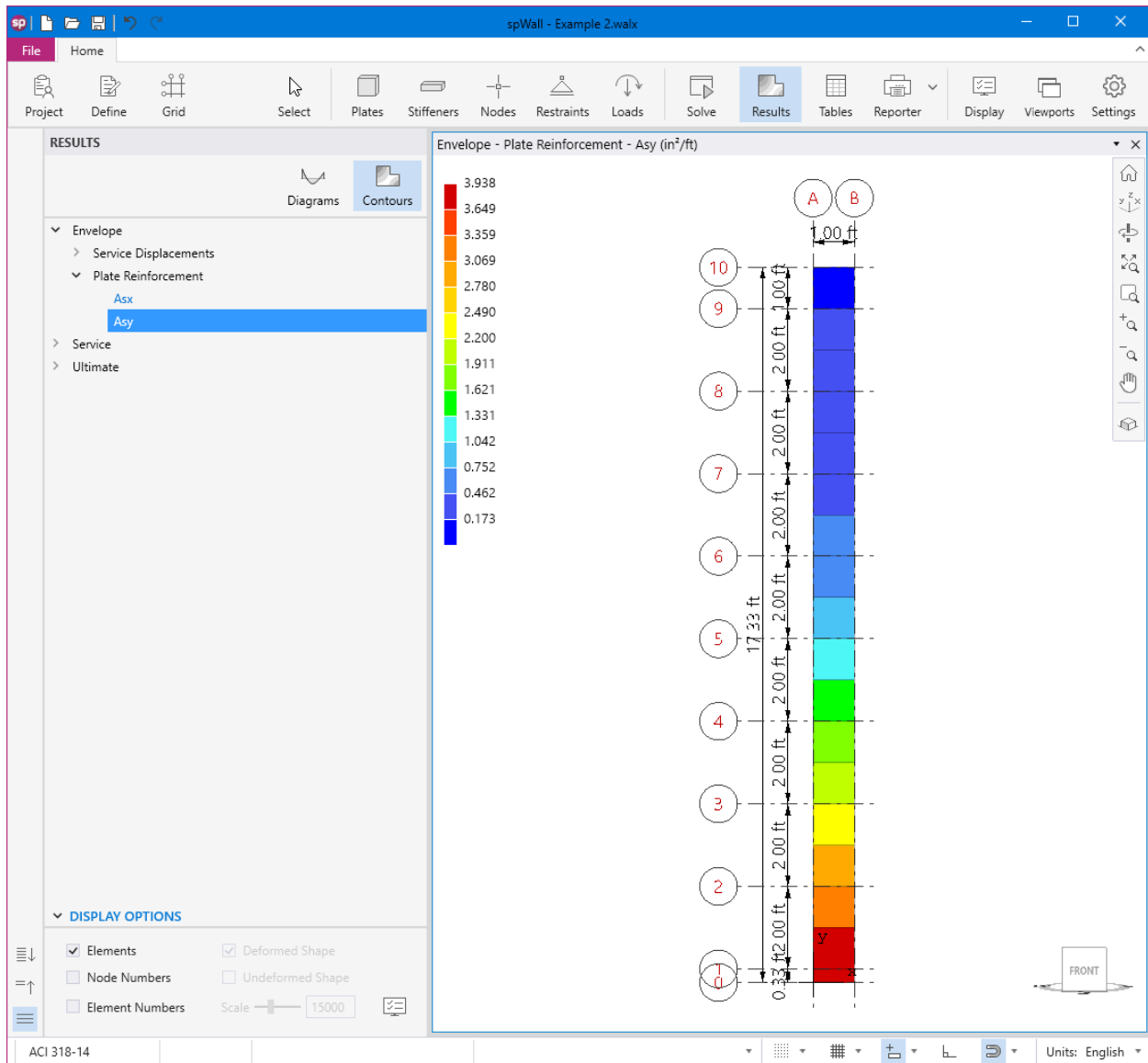

Please be advised that spWall displays the total flexure reinforcement, for each element, for two curtains of reinforcement.

19. Results can be viewed in a force diagram form by selecting **Diagrams** from the left panel.

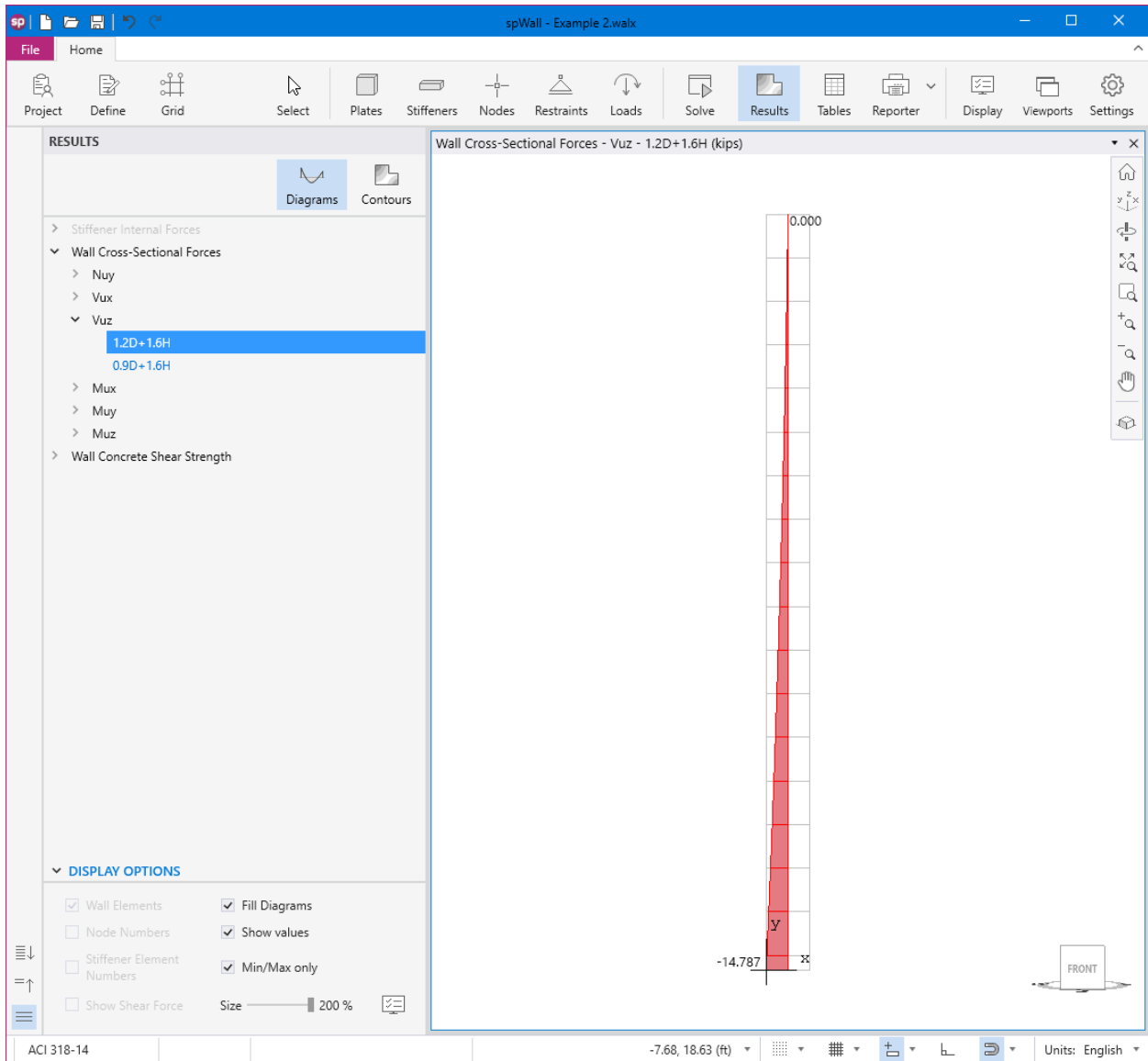

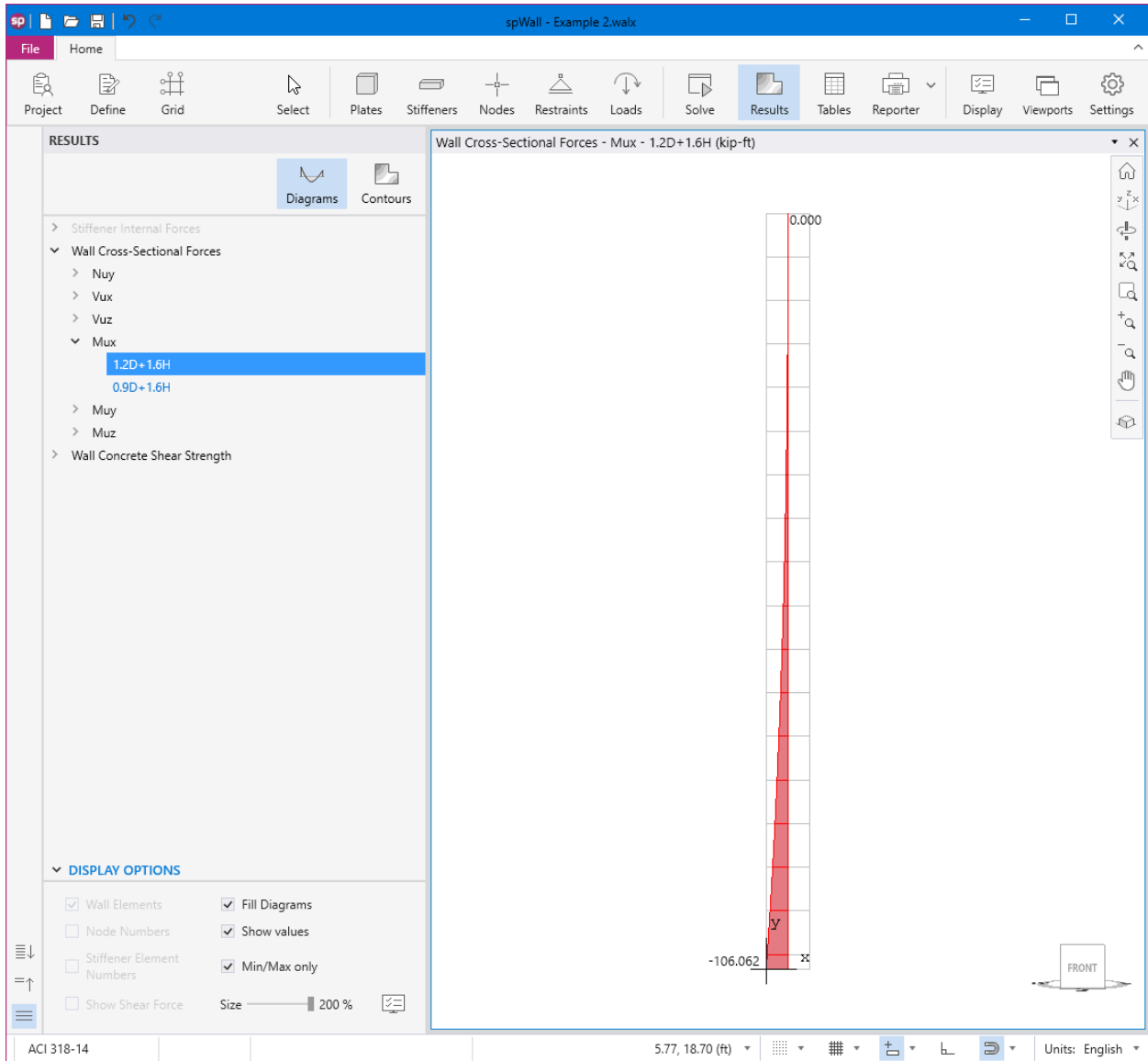

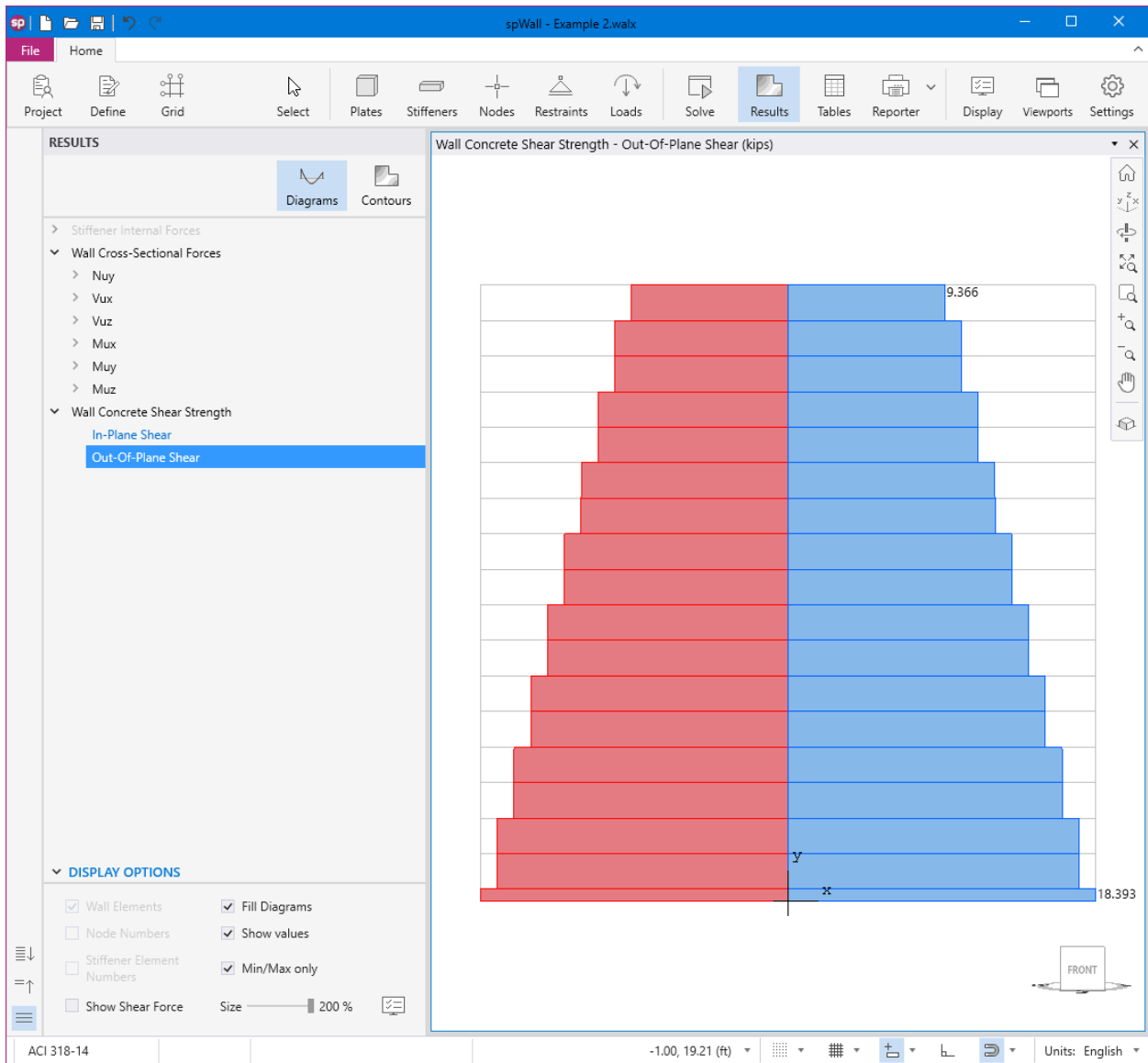

20. Results can be also viewed in table format by selecting the **Tables** command from the **Ribbon**.

Results - Ultimate - Nodal Displacements - 1.2D + 1.6H

NOTE: Coordinate System: Global

Node	Dx	Dy	Dz
	in	in	in
1	0.00000	0.00000	0.00000
2	0.00000	0.00000	0.00000
3	0.00000	-0.00002	-0.00028
4	0.00000	-0.00002	-0.00028
5	0.00000	-0.00008	-0.00529
6	0.00000	-0.00008	-0.00529
7	0.00000	-0.00014	-0.01601
8	0.00000	-0.00014	-0.01601
9	0.00000	-0.00019	-0.03202
10	0.00000	-0.00019	-0.03202
11	0.00000	-0.00024	-0.05286
12	0.00000	-0.00024	-0.05286
13	0.00000	-0.00029	-0.07812
14	0.00000	-0.00029	-0.07812
15	0.00000	-0.00033	-0.10734
16	0.00000	-0.00033	-0.10734
17	0.00000	-0.00037	-0.14009
18	0.00000	-0.00037	-0.14009
19	0.00000	-0.00041	-0.17594
20	0.00000	-0.00041	-0.17594
21	0.00000	-0.00044	-0.21445
22	0.00000	-0.00044	-0.21445
23	0.00000	-0.00047	-0.25520
24	0.00000	-0.00047	-0.25520
25	0.00000	-0.00050	-0.29778

Ranges

Plates All From 1 To 18

Stiffeners All From 1 To 1

Nodes All From 1 To 38

21. Results can be printed or exported in different formats by selecting the **Reporter** command from the **Ribbon**.

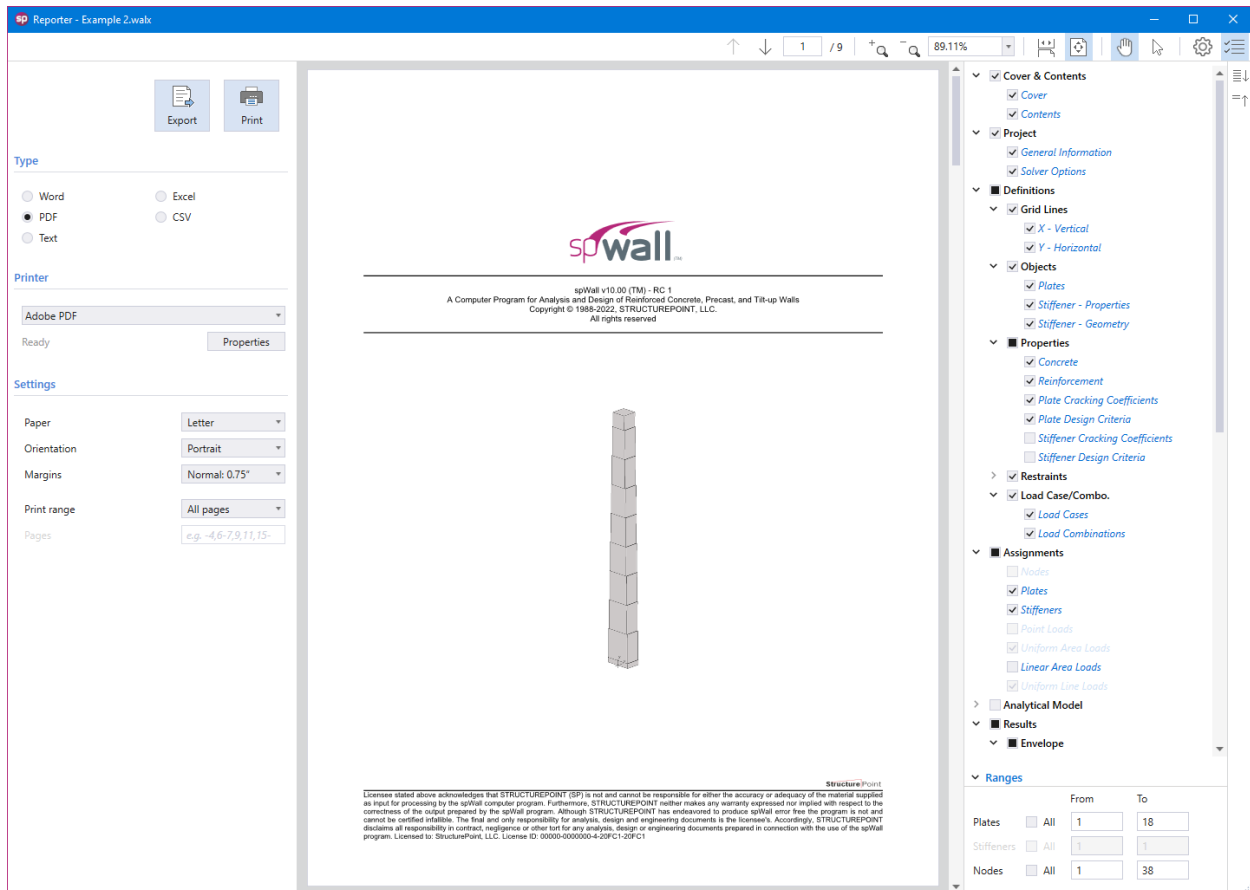

CHAPTER
A

APPENDIX

A.1. Default Load Case and Combination Factors	300
A.1.1. For ACI 318-14/11	303
A.1.2. For ACI 318-08/05	305
A.1.3. For ACI 318-02	307
A.1.4. For CSA A23.3-14/04/94	309
A.2. Import File Formats	313
A.2.1. Grid Data	313
A.2.2. Load Data	314
A.2.3. Load Combination Data	315
A.3. Conversion Factors - English to SI	316
A.4. Conversion Factors - SI to English	317
A.5. Material Strength Value Limits.....	318
A.6. Contact Information	319

A.1. Default Load Case and Combination Factors

Each load is applied to the wall under one of the 26 (A through Z) load cases. The wall is analyzed and designed under load combinations. A load combination is the algebraic sum of each of the load cases multiplied by a load factor.

Load combinations are categorized into service-level and ultimate-level. For each service-level and ultimate-level load combinations, nodal displacement, internal forces in plate and stiffener elements, and reactions are calculated. Additionally, wall cross-sectional forces are calculated for ultimate-level load combinations. The output is available only when solution criteria are met for all load combinations.

For the design of reinforced concrete elements, the required area of steel is calculated due to the element internal forces from the ultimate level combinations. On the other hand, displacement envelopes are determined using the displacement from the service level combinations.

Basic load cases and the corresponding load factors for service and ultimate load combinations are provided as suggested defaults in the input file templates (activated in SETTINGS / STARTUP DEFAULTS) to facilitate user's input. The default load cases and load combination factors should be modified as necessary at the discretion of the user to meet code provisions and project requirements.

The following default load cases are suggested: A – Dead (D), B – Live (L), C – Snow (S), D – Wind (W), and E – Earthquake (E). Service-level load values are considered for all load cases except case E, in all design codes, and case W, in ACI 318-14 and ACI 318-11 only, which are taken at ultimate level. The suggested default load combination factors for service and ultimate levels are shown below. Under the service load level, allowable stress design load factors are considered per related IBC and NBCC edition. Under the ultimate load level, the load factors are considered per related ACI 318, and CSA A23.3 edition. The user should introduce a new set of service level and ultimate level load combinations for specific project and modeling needs such as checking displacement, drift limits or different applications such as liquid containing tank walls, tilt-up walls, shear walls, retaining walls to name a few. The suggested and subsequently generated

load combinations in the Program are just suggestions and they must be thoroughly reviewed by the design professional to ensure their suitability for the specific project at hand and must be updated or modified as required.

For example, in ACI 318-14/11/08/05/02, for service load combinations, the user may choose to utilize the corresponding ASCE 7, Commentary on Appendix C, Serviceability Considerations. The service level load combinations per this criterion are given below for informational purposes only. The design professional shall ensure their suitability for the specific project at hand and these factors must also be updated or modified as required.

For ACI 318-14/11

- Service load combination¹

$$S1 = 1.0D + 1.0L$$

$$S2 = 1.0D + 0.5S$$

$$S3 = 1.0D + 0.5L$$

$$S4 = 1.0D + 0.5L + 1.0W$$

$$S5 = 1.0D + 0.5L - 1.0W$$

Wind load value, W , above is taken at ultimate level in ASCE 7-10 and applicable to ACI 318-14/11. The service level load factor for W can be calculated as W_a/W , where W_a is the service-level wind load. A factor of 1.0 is provided conservatively as the default load factor since the W_a/W ratio depends on location, occupancy category, exposure, and MRI. The user should modify the factor based on the actual W_a/W ratio. Alternatively, the user may represent service and ultimate wind load levels (W_a and W respectively) by defining them directly under separate load cases and by modifying their corresponding load factors to 0.0 and 1.0 so that the service level wind load is active only in service level combinations and the ultimate level wind load is active only in the ultimate level combinations.

¹ ASCE 7-10, Commentary, Appendix C, Serviceability Considerations; ACI 318-14, 11.8.1.1(e), 11.8.4.1, 11.8.4.2, 11.8.4.3, 11.8.4.4; ACI 318-11, R14.8.4

For ACI 318-08

- Service load combinations²

$$S1 = 1.0D + 1.0L$$

$$S2 = 1.0D + 0.5S$$

$$S3 = 1.0D + 0.5L$$

$$S4 = 1.0D + 0.5L + 0.7W$$

$$S5 = 1.0D + 0.5L - 0.7W$$

For ACI 318-05/02

- Service load combinations³

$$S1 = 1.0D + 1.0L$$

$$S2 = 1.0D + 0.5S$$

$$S3 = 1.0D + 0.5L$$

$$S4 = 1.0D + 0.5L + 0.7W$$

$$S5 = 1.0D + 0.5L - 0.7W$$

Any load combination in the Tables below is VALID only if all Principal Loads exist for a given load combination. The Companion Load has no impact in the validity of a given load combination.

² ASCE 7-05, Errata, Chapter C Appendix C (Commentary on Appendix C), ACI 318-08, R14.8.4

³ ASCE 7-05, Errata, Chapter C Appendix C (Commentary on Appendix C); ASCE 7-02, Commentary, Section CB Serviceability Considerations

A.1.1. For ACI 318-14/11

- Service load combinations:

Service Load Combinations – ACI 318 – 14 / 11							
Load Combo	Dead D	Live L	Snow S	Wind W	EQ E	Principal Loads	Companion Loads
S1	1.00					D	-
S2	1.00	1.00				D, L	-
S3	1.00		1.00			D, S	-
S4	1.00	0.75	0.75			D, L, S	-
S5	1.00			0.60		D, W	-
S6	1.00			-0.60		D, W	-
S7	1.00				0.70	D, E	-
S8	1.00				-0.70	D, E	-
S9	1.00	0.75	0.75	0.45		D, L, W	S
	1.00	0.75	0.75	0.45		D, S, W	L
S10	1.00	0.75	0.75	-0.45		D, L, W	S
	1.00	0.75	0.75	-0.45		D, S, W	L
S11	1.00	0.75	0.75		0.525	D, L, E	S
	1.00	0.75	0.75		0.525	D, S, E	L
S12	1.00	0.75	0.75		-0.525	D, L, E	S
	1.00	0.75	0.75		-0.525	D, S, E	L
S13	0.60			0.60		D, W	-
S14	0.60			-0.60		D, W	-
S15	0.60				0.70	D, E	-
S16	0.60				-0.70	D, E	-

- Ultimate load combinations:

Ultimate Load Combinations – ACI 318 – 14 / 11							
Load Combo	Dead D	Live L	Snow S	Wind W	EQ E	Principal Loads	Companion Loads
U1	1.40					D	-
U2	1.20	1.60	0.50			D, L	S
U3	1.20	1.00	1.60			D, S	L
U4	1.20		1.60	0.50		D, S	W
U5	1.20		1.60	-0.50		D, S	W
U6	1.20	1.00	0.50	1.00		D, W	L, S
U7	1.20	1.00	0.50	-1.00		D, W	L, S
U8	1.20	1.00	0.20		1.00	D, E	L, S
U9	1.20	1.00	0.20		-1.00	D, E	L, S
U10	0.90			1.00		D, W	-
U11	0.90			-1.00		D, W	-
U12	0.90				1.00	D, E	-
U13	0.90				-1.00	D, E	-

A.1.2. For ACI 318-08/05

- Service load combinations:

Service Load Combinations – ACI 318 – 08 / 05							
Load Combo	Dead D	Live L	Snow S	Wind W	EQ E	Principal Loads	Companion Loads
S1	1.00					D	-
S2	1.00	1.00				D, L	-
S3	1.00		1.00			D, S	-
S4	1.00	0.75	0.75			D, L, S	-
S5	1.00			1.00		D, W	-
S6	1.00			-1.00		D, W	-
S7	1.00				0.70	D, E	-
S8	1.00				-0.70	D, E	-
S9	1.00	0.75	0.75	0.75		D, L, W	S
	1.00	0.75	0.75	0.75		D, S, W	L
S10	1.00	0.75	0.75	-0.75		D, L, W	S
	1.00	0.75	0.75	-0.75		D, S, W	L
S11	1.00	0.75	0.75		0.525	D, L, E	S
	1.00	0.75	0.75		0.525	D, S, E	L
S12	1.00	0.75	0.75		-0.525	D, L, E	S
	1.00	0.75	0.75		-0.525	D, S, E	L
S13	0.60			1.00		D, W	-
S14	0.60			-1.00		D, W	-
S15	0.60				0.70	D, E	-
S16	0.60				-0.70	D, E	-

- Ultimate load combinations:

Ultimate Load Combinations – ACI 318 – 08 / 05							
Load Combo	Dead D	Live L	Snow S	Wind W	EQ E	Principal Loads	Companion Loads
U1	1.40					D	-
U2	1.20	1.60	0.50			D, L	S
U3	1.20	1.00	1.60			D, S	L
U4	1.20		1.60	0.80		D, S	W
U5	1.20		1.60	-0.80		D, S	W
U6	1.20	1.00	0.50	1.60		D, W	L, S
U7	1.20	1.00	0.50	-1.60		D, W	L, S
U8	1.20	1.00	0.20		1.00	D, E	L, S
U9	1.20	1.00	0.20		-1.00	D, E	L, S
U10	0.90			1.60		D, W	-
U11	0.90			-1.60		D, W	-
U12	0.90				1.00	D, E	-
U13	0.90				-1.00	D, E	-

A.1.3. For ACI 318-02

- Service load combinations:

Service Load Combinations – ACI 318 – 02							
Load Combo	Dead D	Live L	Snow S	Wind W	EQ E	Principal Loads	Companion Loads
S1	1.00					D	-
S2	1.00	1.00				D, L	-
S3	1.00	1.00	1.00			D, S	L
S4	1.00	1.00	1.00	1.00		D, L, W	S
	1.00	1.00	1.00	1.00		D, S, W	L
S5	1.00	1.00	1.00	-1.00		D, L, W	S
	1.00	1.00	1.00	-1.00		D, S, W	L
S6	1.00	1.00	1.00		0.70	D, L, E	S
	1.00	1.00	1.00		0.70	D, S, E	L
S7	1.00	1.00	1.00		-0.70	D, L, E	S
	1.00	1.00	1.00		-0.70	D, S, E	L
S8	0.60			1.00		D, W	-
S9	0.60			-1.00		D, W	-
S10	0.60				0.70	D, E	-
S11	0.60				-0.70	D, E	-

- Ultimate load combinations:

Ultimate Load Combinations – ACI 318 – 02							
Load Combo	Dead D	Live L	Snow S	Wind W	EQ E	Principal Loads	Companion Loads
U1	1.40					D	-
U2	1.20	1.60	0.50			D, L	S
U3	1.20	1.00	1.60			D, S	L
U4	1.20		1.60	0.80		D, S	W
U5	1.20		1.60	-0.80		D, S	W
U6	1.20	1.00	0.50	1.60		D, W	L, S
U7	1.20	1.00	0.50	-1.60		D, W	L, S
U8	1.20	1.00	0.20		1.00	D, E	L, S
U9	1.20	1.00	0.20		-1.00	D, E	L, S
U10	0.90			1.60		D, W	-
U11	0.90			-1.60		D, W	-
U12	0.90				1.00	D, E	-
U13	0.90				-1.00	D, E	-

A.1.4. For CSA A23.3-14/04/94

- Service load combinations:

Service Load Combinations – CSA A23.3 – 14 / 04 / 94							
Load Combo	Dead D	Live L	Snow S	Wind W	EQ E	Principal Loads	Companion Loads
S1	1.00					D	-
S2	1.00	1.00				D, L	-
S3	1.00	1.00	1.00			D, S	L
S4	0.75	0.75	0.75	0.75		D, L, W	S
	0.75	0.75	0.75	0.75		D, S, W	L
S5	0.75	0.75	0.75	-0.75		D, L, W	S
	0.75	0.75	0.75	-0.75		D, S, W	L
S6	0.75	0.75	0.75		0.50	D, L, E	S
	0.75	0.75	0.75		0.50	D, S, E	L
S7	0.75	0.75	0.75		-0.50	D, L, E	S
	0.75	0.75	0.75		-0.50	D, S, E	L
S8	1.00			1.00		D, W	-
S9	1.00			-1.00		D, W	-
S10	1.00				0.667	D, E	-
S11	1.00				-0.667	D, E	-

- Ultimate load combinations for CSA A23.3-14:

Ultimate Load Combinations – CSA A23.3 – 14							
Load Combo	Dead D	Live L	Snow S	Wind W	EQ E	Principal Loads	Companion Loads
U1	1.40					D	-
U2	1.25	1.50	1.00			D, L	S
U3	0.90	1.50	1.00			D, L	S
U4	1.25	1.50		0.40		D, L	W
U5	1.25	1.50		-0.40		D, L	W
U6	0.90	1.50		0.40		D, L	W
U7	0.90	1.50		-0.40		D, L	W
U8	1.25	1.00	1.50			D, S	L
U9	0.90	1.00	1.50			D, S	L
U10	1.25		1.50	0.40		D, S	W
U11	1.25		1.50	-0.40		D, S	W
U12	0.90		1.50	0.40		D, S	W
U13	0.90		1.50	-0.40		D, S	W
U14	1.25	0.50		1.40		D, W	L
U15	1.25	0.50		-1.40		D, W	L
U16	1.25		0.50	1.40		D, W	S
U17	1.25		0.50	-1.40		D, W	S
U18	0.90	0.50		1.40		D, W	L
U19	0.90	0.50		-1.40		D, W	L
U20	0.90		0.50	1.40		D, W	S
U21	0.90		0.50	-1.40		D, W	S
U22	1.00	0.50	0.25		1.00	D, E	L, S
U23	1.00	0.50	0.25		-1.00	D, E	L, S

- Ultimate load combinations for CSA A23.3-04:

Ultimate Load Combinations – CSA A23.3 – 04							
Load Combo	Dead D	Live L	Snow S	Wind W	EQ E	Principal Loads	Companion Loads
U1	1.40					D	-
U2	1.25	1.50	0.50			D, L	S
U3	0.90	1.50	0.50			D, L	S
U4	1.25	1.50		0.40		D, L	W
U5	1.25	1.50		-0.40		D, L	W
U6	0.90	1.50		0.40		D, L	W
U7	0.90	1.50		-0.40		D, L	W
U8	1.25	0.50	1.50			D, S	L
U9	0.90	0.50	1.50			D, S	L
U10	1.25		1.50	0.40		D, S	W
U11	1.25		1.50	-0.40		D, S	W
U12	0.90		1.50	0.40		D, S	W
U13	0.90		1.50	-0.40		D, S	W
U14	1.25	0.50		1.40		D, W	L
U15	1.25	0.50		-1.40		D, W	L
U16	1.25		0.50	1.40		D, W	S
U17	1.25		0.50	-1.40		D, W	S
U18	0.90	0.50		1.40		D, W	L
U19	0.90	0.50		-1.40		D, W	L
U20	0.90		0.50	1.40		D, W	S
U21	0.90		0.50	-1.40		D, W	S
U22	1.00	0.50	0.25		1.00	D, E	L, S
U23	1.00	0.50	0.25		-1.00	D, E	L, S

- Ultimate load combinations for CSA A23.3-94:

Ultimate Load Combinations – CSA A23.3 – 94							
Load Combo	Dead D	Live L	Snow S	Wind W	EQ E	Principal Loads	Companion Loads
U1	1.25					D	-
U2	1.25	1.50	1.50			D, L	S
	1.25	1.50	1.50			D, S	L
U3	0.85	1.50	1.50			D, L	S
	0.85	1.50	1.50			D, S	L
U4	1.25	1.05	1.05	1.05		D, L, W	S
	1.25	1.05	1.05	1.05		D, S, W	L
U5	1.25	1.05	1.05	-1.05		D, L, W	S
	1.25	1.05	1.05	-1.05		D, S, W	L
U6	0.85	1.05	1.05	1.05		D, L, W	S
	0.85	1.05	1.05	1.05		D, S, W	L
U7	0.85	1.05	1.05	-1.05		D, L, W	S
	0.85	1.05	1.05	-1.05		D, S, W	L
U8	1.25			1.50		D, W	-
U9	1.25			-1.50		D, W	-
U10	0.85			1.50		D, W	-
U11	0.85			-1.50		D, W	-
U12	1.00				1.00	D, E	-
U13	1.00				-1.00	D, E	-
U14	1.00	0.50	0.50		1.00	D, L, E	S
	1.00	0.50	0.50		1.00	D, S, E	L
U15	1.00	0.50	0.50		-1.00	D, L, E	S
	1.00	0.50	0.50		1.00	D, S, E	L

A.2. Import File Formats

Grid, load, and load combination data may be imported from a text file. The import file must be saved in pure ASCII (text) format. Data fields on each line should be separated by spaces or TABs. Comments or blank lines should not be placed within the import file. The first line of each text file must be the unique keyword associated with the input.

A.2.1. Grid Data

```
GRID      // Keyword
3         // Number of vertical grid lines
A   0.0   // Label of vertical grid line      X coordinate of vertical grid line
B   18.0
C   36.0
5         // Number of horizontal grid lines
0   0.0   // Label of horizontal grid line    Y coordinate of horizontal grid line
1   14.0
2   26.0
3   38.0
4   41.0
```

A.2.2. Load Data

```

LOADCASES      // Keyword
1              // Number of point loads
Dead DL       // Load case type   Load case label
Live LL
Wind W

              // Space
POINTS        // Keyword
1  0.0  38.0  // Point number   X Coordinate   Y Coordinate
2  6.0  38.0
3 12.0  38.0

LOADS         // Keyword
1 DL         0.0 -1.2 10.0 0.0 0.0 0.0 0.0
1 LL         0.0  0.0  0.0 0.0 0.0 0.0 0.0
1 W          0.0  0.0  0.0 0.0 0.0 0.0 0.0
2 DL         0.0 -2.4 10.0 0.0 0.0 0.0 0.0
2 LL         0.0  0.0  0.0 0.0 0.0 0.0 0.0
2 W          0.0  0.0  0.0 0.0 0.0 0.0 0.0
3 DL         0.0 -2.4 10.0 0.0 0.0 0.0 0.0
3 LL         0.0  0.0  0.0 0.0 0.0 0.0 0.0
2 W          0.0  0.0  0.0 0.0 0.0 0.0 0.0

              // Point number   Load case label   Px   Py   Pz   Ec   Mx   My   Mz

```

A.2.3. Load Combination Data

```

COMBINATIONS      // Keyword
1                 // Parameter indicating self-weight
3                 // Number of service load combinations
S1 1.0    1.0    0.0 // Label coefficient for each load case type
S2 1.0    1.0    1.0
S3 1.0    0.0    1.0
6                 // Number of ultimate load combinations
U1 1.4    0.0    0.0 // Label coefficient for each load case type
U2 1.2    1.6    0.0
U3 1.2    1.0    1.0
U4 1.2    1.0   -1.0
U5 0.9    0.0    1.0
U6 0.9    0.0   -1.0
  
```

A.3. Conversion Factors – English to SI

To convert from	To	Multiply by
in.	m (1000 mm)	0.025400
ft	m	0.304800
lb	N (0.001 kN)	4.448222
kip (1000 lbs)	kN	4.448222
plf (lb/ft)	N/m	14.593904
psi (lb/in. ²)	kPa	6.894757
ksi (kips/in. ²)	MPa	6.894757
psf (lb/ft ²)	N/m ² (Pa)	47.88026
pcf (lb/ft ³)	kg/m ³	16.018460
ft-kips	kN × m	1.355818

A.4. Conversion Factors – SI to English

To convert from	To	Multiply by
m (1000 mm)	in.	39.37008
m	ft	3.28084
N (0.001 kN)	lb	0.224809
kN	kip (1000 lbs)	0.224809
kN/m	plf (lb/ft)	68.52601
MPa	psi (lb/in. ²)	145.0377
MPa	ksi (kips/in. ²)	0.145038
kN/m ² (kPa)	psf (lb/ft ²)	20.88555
kg/m ³	pcf (lb/ft ³)	0.062428
kN × m	ft-kips	0.737562

A.5. Material Strength Value Limits

Material Strength	ACI		CSA	
	Min.	Max.	Min.	Max.
f_c	0.5 ksi	20 ksi	3.5 MPa	138 MPa
f_y	25 ksi	120 ksi	170 MPa	825 MPa

A.6. Contact Information

Web Site: www.StructurePoint.org

E-mail: info@StructurePoint.org
support@StructurePoint.org

Address: StructurePoint, LLC.
5420 Old Orchard Road
Skokie, IL 60077
USA

Phone: +1- 847- 966- 4357

Fax: +1- 847- 966- 1542